



NHÔM ĐÔNG Á
東亞鋁業



EAST ASIA

NHÔM ĐÔNG Á
東亞鋁業

GIỚI THIỆU VỀ CÔNG TY TNHH NHÔM ĐÔNG Á

Công ty TNHH Nhôm Đông Á nằm ở TP. Chí Linh tỉnh Hải Dương, là nhà máy sản xuất hiện đại, quy mô lớn về sản xuất nhôm thanh định hình tại Việt Nam. Công ty chính thức đi vào hoạt động sản xuất từ năm 2009. Với tổng diện tích đất là 70.000 m², tổng diện tích xây dựng là 50.000 m², tổng vốn đầu tư là 50.000.000 USD, tổng số công nhân viên hơn 1.200 người, tổng sản lượng hàng năm đạt trên 50.000 tấn. Công ty TNHH Nhôm Đông Á đã và đang là một trong những nhà sản xuất nhôm hợp kim lớn nhất tại Việt Nam. Đồng thời cũng là một trong những đơn vị chủ đạo thiết lập lên tiêu chuẩn về ngành công nghiệp nhôm hợp kim ở Việt Nam.

東亞鋁業

Công ty TNHH Nhôm Đông Á tích hợp 4 yếu tố: thiết kế; nghiên cứu và phát triển; sản xuất; kinh doanh. Dây chuyền sản xuất của Công ty TNHH Nhôm Đông Á sử dụng các loại thiết bị sản xuất và các công cụ kiểm tra tiên tiến bậc nhất được nhập khẩu từ nước ngoài. Với một quy trình sản xuất khép kín, bao gồm các công đoạn: đúc nhôm, ép nhôm, mạ, mạ tĩnh điện, phun sơn, vân gỗ, phun nhựa, gia công. Phương châm của công ty là: chất lượng là mục tiêu hàng đầu, không ngừng cải tiến, khách hàng là trung tâm, hiệu quả thiết thực. Nhằm nâng cao hơn nữa hiệu quả sản xuất, công ty đã sử dụng hệ thống ERP để quản lý dữ liệu thông tin trên máy tính, và sử dụng phương pháp đánh giá thành tích cho các bộ phận nhằm nâng cao hiệu suất làm việc. Trong quá trình sản xuất, tiêu chuẩn ASTM-B221 của Mỹ được thực hiện nghiêm ngặt, nghiêm túc thực hiện theo tiêu chuẩn quản lý chất lượng ISO 9001 và hệ thống quản lý môi trường ISO14001, đảm bảo chất lượng sản phẩm ổn định, và đã được thông qua Chứng nhận Qualicoat của EU. Các sản phẩm của công ty không chỉ được tiêu thụ mạnh tại thị trường Việt Nam, mà còn được xuất khẩu sang thị trường các nước Mỹ, Canada, Úc và Châu Âu v...v... .



NHÔM ĐÔNG Á

Ban lãnh đạo công ty còn nhấn mạnh công ty kinh doanh với tiêu chí: con người là căn bản, đổi mới là hàng đầu, chuyên nghiệp và có uy tín. Thành công của Nhôm Đông Á thuộc về: mục tiêu cao, quản lý chặt chẽ, công nghệ tiên tiến, sự tin tưởng và hỗ trợ của khách hàng. Công ty TNHH Nhôm Đông Á sẽ tiếp tục hướng tới sự hài lòng của khách hàng với các sản phẩm hạng nhất và dịch vụ tốt nhất.



NHÔM ĐÔNG Á

HỆ THỐNG QUẢN LÝ CHẤT LƯỢNG HOÀN THIỆN

THIẾT BỊ GIA CÔNG TIÊN TIẾN VÀ HIỆU QUẢ

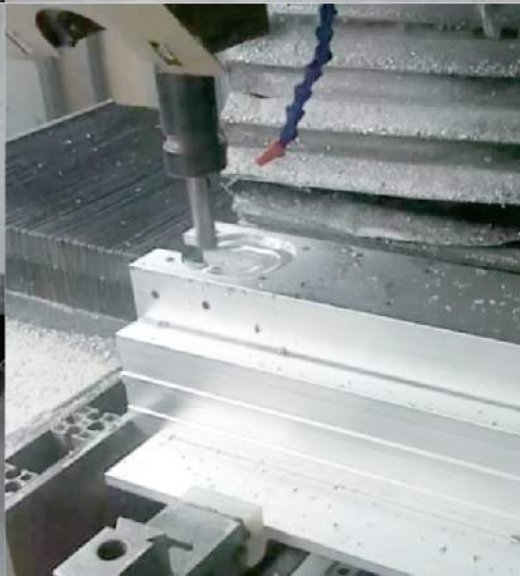
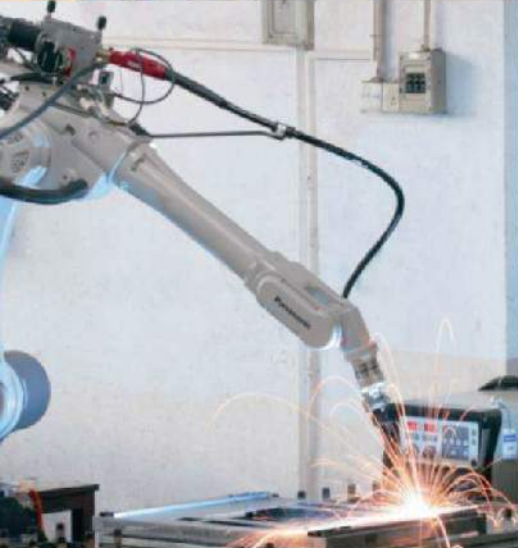
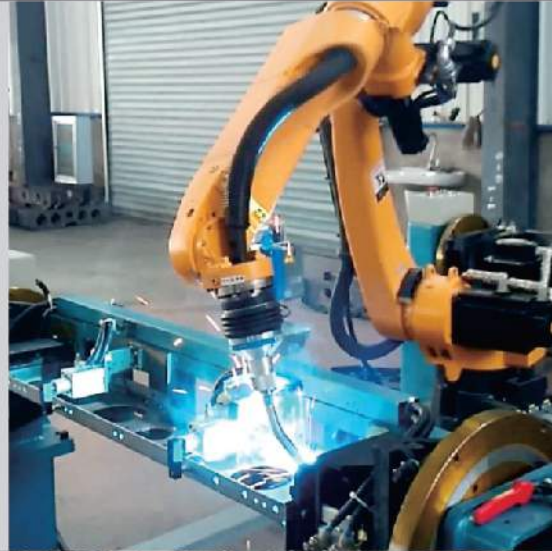

HỆ CỬA THỦY LỰC DY-160

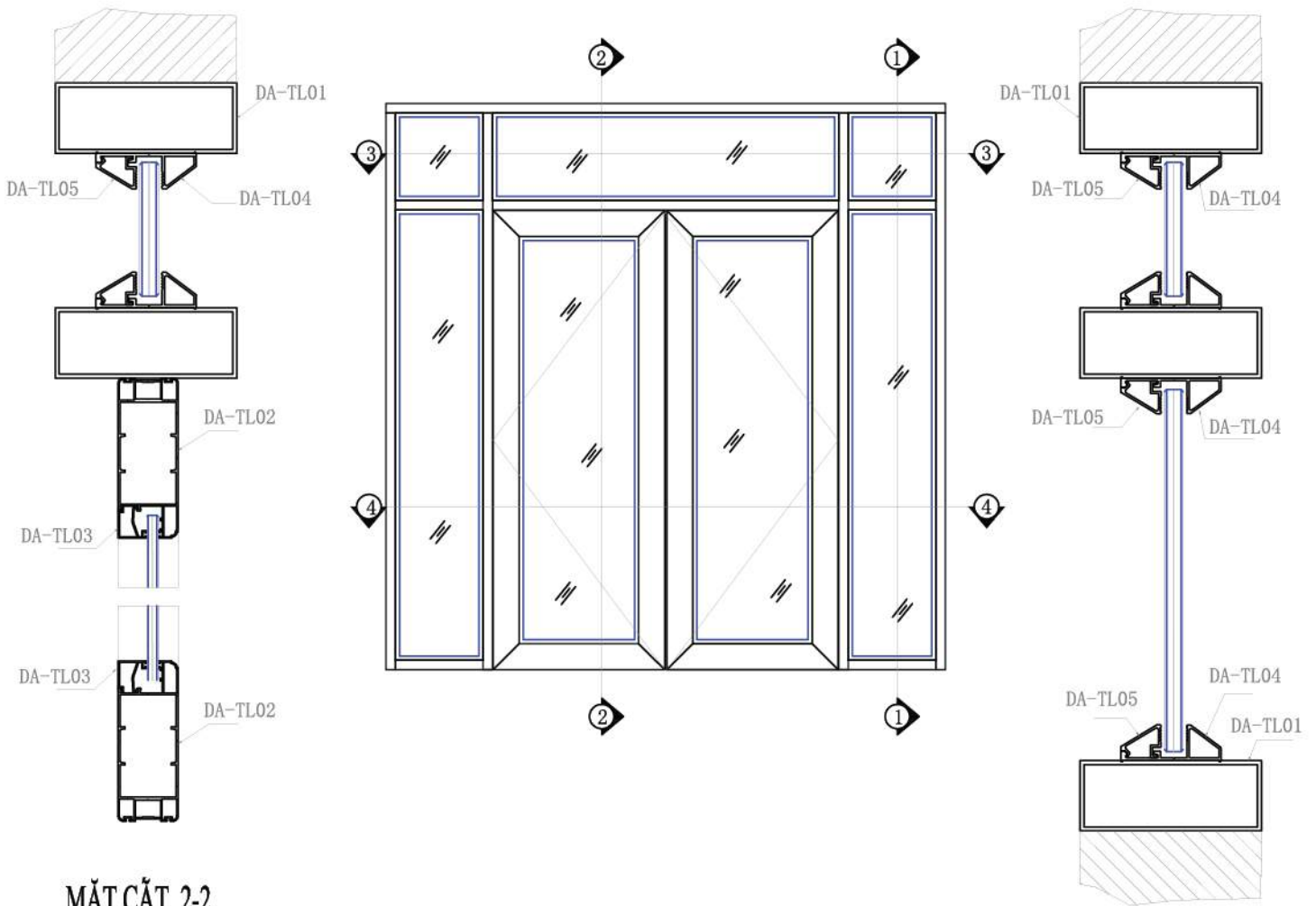

MẶT CẮT 2-2

MẶT CẮT 1-1

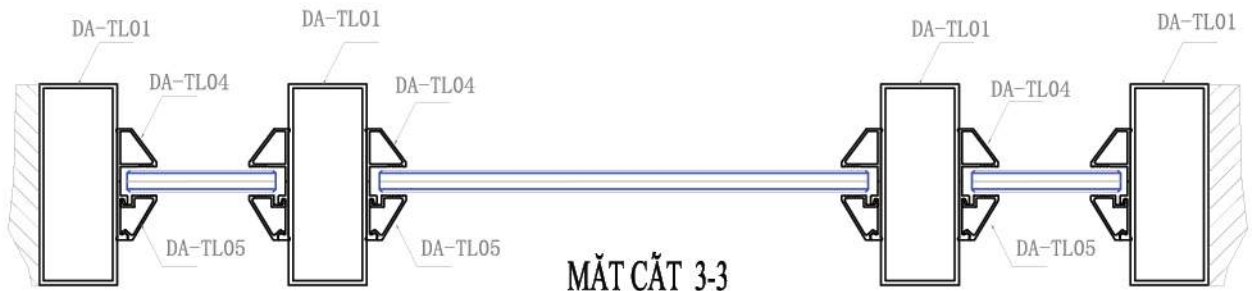

MẶT CẮT 3-3

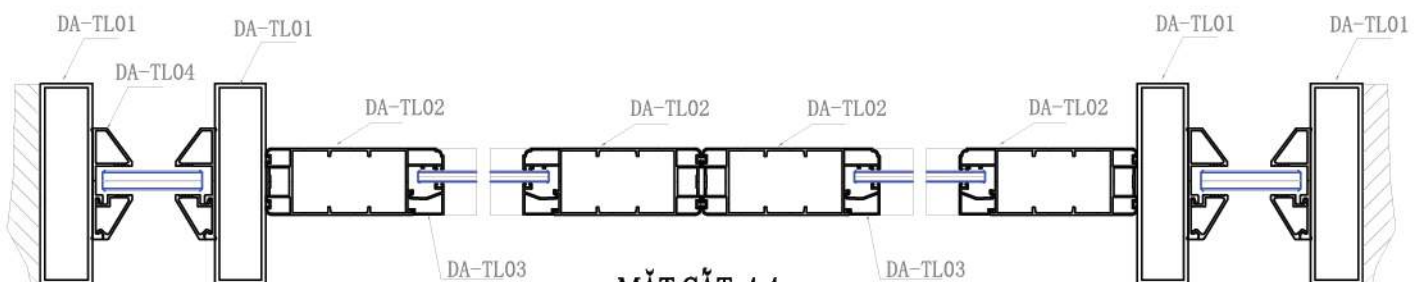

MẶT CẮT 4-4

LIST MẶT CẮT HỆ CỬA THỦY LỰC DY-160

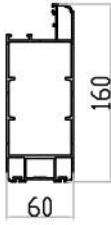
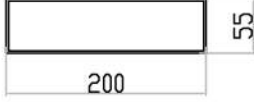
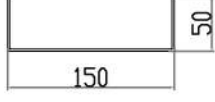
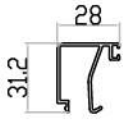
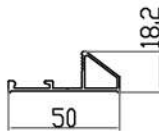
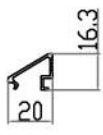
CÁNH THỦY LỰC				KHUNG BAO LỚN				KHUNG BAO NHỎ			
											
Mã mới	Mã cũ	Độ dày	Trọng lượng	Mã mới	Mã cũ	Độ dày	Trọng lượng	Mã mới	Mã cũ	Độ dày	Trọng lượng
DYG19902200	DA-TL02	2.0	2.819 kg/m	DYF11212250	DA-TL01	2.5 mm	3.388 kg/m	DYF10538200	ME0000574	2.0 mm	2.117 kg/m
SẬP CÁNH				ĐỀ SẬP				SẬP KÍNH Ồ FIX			
											
Mã mới	Mã cũ	Độ dày	Trọng lượng	Mã mới	Mã cũ	Độ dày	Trọng lượng	Mã mới	Mã cũ	Độ dày	Trọng lượng
DYG19901130	DA-TL03	1.30 mm	0.374 kg/m	DYG20182140	DA-TL04	1.40	0.352	DYG20183100	DA-TL05	1.00	0.147
Mã mới	Mã cũ	Độ dày	Trọng lượng	Mã mới	Mã cũ	Độ dày	Trọng lượng	Mã mới	Mã cũ	Độ dày	Trọng lượng
Mã mới	Mã cũ	Độ dày	Trọng lượng	Mã mới	Mã cũ	Độ dày	Trọng lượng	Mã mới	Mã cũ	Độ dày	Trọng lượng
Mã mới	Mã cũ	Độ dày	Trọng lượng	Mã mới	Mã cũ	Độ dày	Trọng lượng	Mã mới	Mã cũ	Độ dày	Trọng lượng

HỆ CỬA ĐI MỞ QUAY DY-55

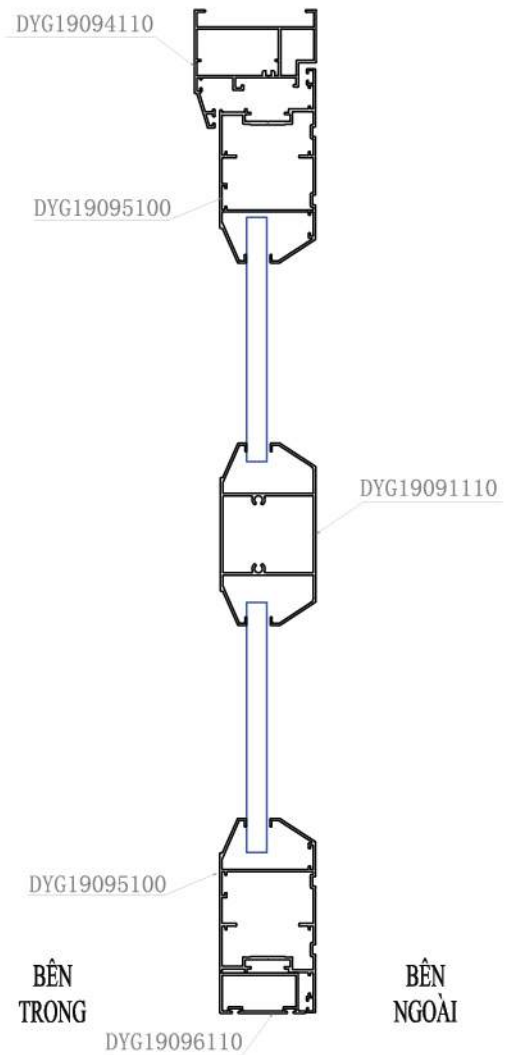
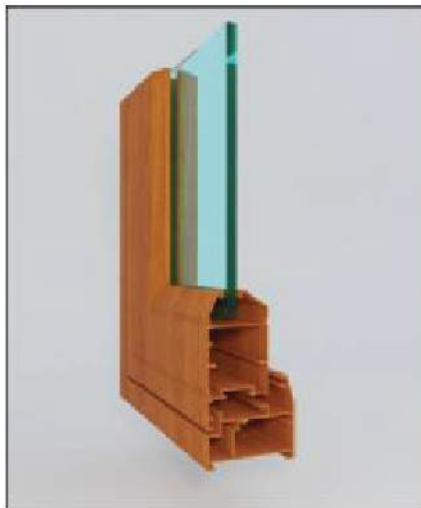
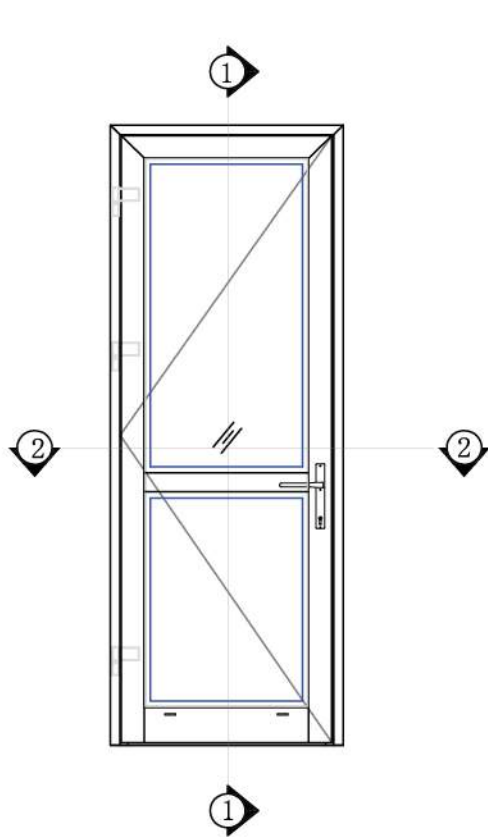

MẶT CẮT 1-1

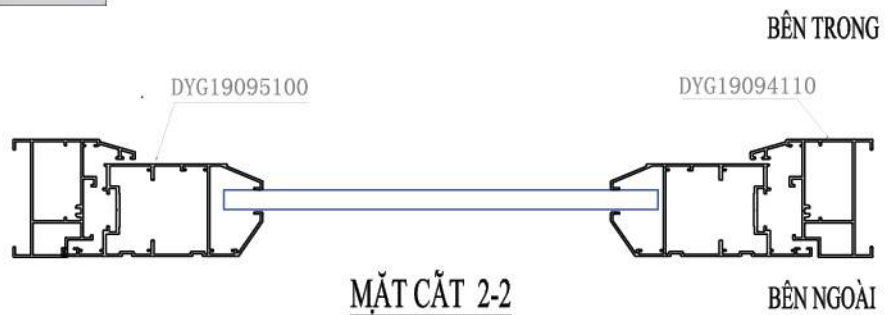

MẶT CẮT 2-2

LIST MẶT CẮT HỆ DY - 55 (Y)

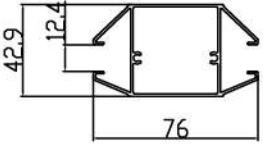
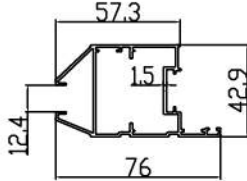
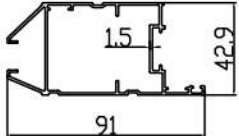
Đổ chia cánh (liền sập)				cánh cửa sổ				cánh cửa đi			
											
Mã mới	Mã cũ	Độ dày	Trọng lượng	Mã mới	Mã cũ	Độ dày	Trọng lượng	Mã mới	Mã cũ	Độ dày	Trọng lượng
DYL5503-2	TD76-Y	1.15 mm	0.913 kg/m	DYL5502-2	S76-Y	1.15 mm	0.885 kg/m	DYM5502-2	D91-Y	1.15 mm	0.98 kg/m

LIST MẶT CẮT HỆ DY - 55 (P)

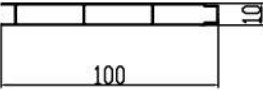
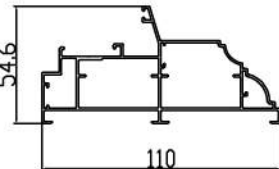
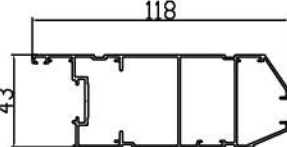
Lá hộp phẳng				Khung bao 110				cánh cửa đi 118			
											
Mã mới	Mã cũ	Độ dày	Trọng lượng	Mã mới	Mã cũ	Độ dày	Trọng lượng	Mã mới	Mã cũ	Độ dày	Trọng lượng
DY510004050	5104A	0.5 mm	0.324 kg/m	DYG20325100	K110-P	1.0 mm	1.224 kg/m	DYG20326100	D118-P	1.0 mm	1.193 kg/m

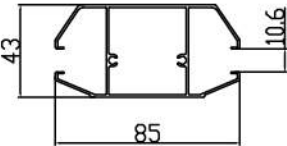
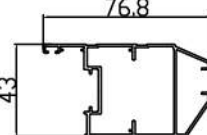
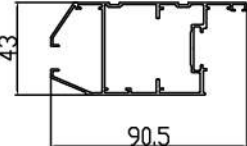
Đổ chia cánh (liền sập)				cánh cửa sổ				cánh cửa đi			
											
Mã mới	Mã cũ	Độ dày	Trọng lượng	Mã mới	Mã cũ	Độ dày	Trọng lượng	Mã mới	Mã cũ	Độ dày	Trọng lượng
DYG19091110	TD76-P	1.10 mm	0.929 kg/m	DYG19092100, REV1	S76-P, REV1	1.10 mm	0.809 kg/m	DYG19095100, REV1	D91-P, REV1	1.0 mm	0.927 kg/m

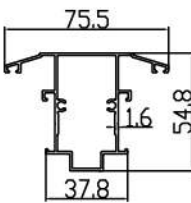
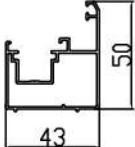
Sập kính				Đổ T chia vách				Đổ động			
											
Mã mới	Mã cũ	Độ dày	Trọng lượng	Mã mới	Mã cũ	Độ dày	Trọng lượng	Mã mới	Mã cũ	Độ dày	Trọng lượng
DYG19100110	SV55-P	1.10 mm	0.22 kg/m	DYG19093110	T55-P	1.10 mm	0.853 kg/m	DYG19099105	DD55-P	1.05 mm	0.64 kg/m

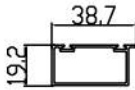
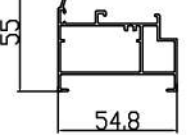
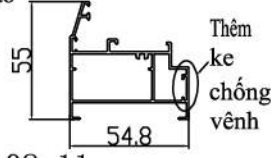
QUÉT SÀN				Khung bao				Khung bao			
											
Mã mới	Mã cũ	Độ dày	Trọng lượng	Mã mới	Mã cũ	Độ dày	Trọng lượng	Mã mới	Mã cũ	Độ dày	Trọng lượng
DYG19096110	C91-P	1.10 mm	0.339 kg/m	DYG19094110	K55-P	1.10 mm	0.746 kg/m	DYG19094110REV1	K55-P, REV1	1.10 mm	0.759 kg/m

HỆ CỬA ĐI MỞ QUAY DY - 56

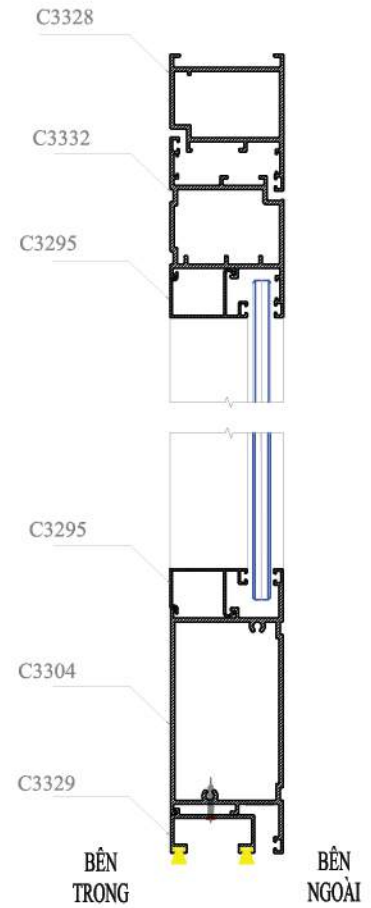
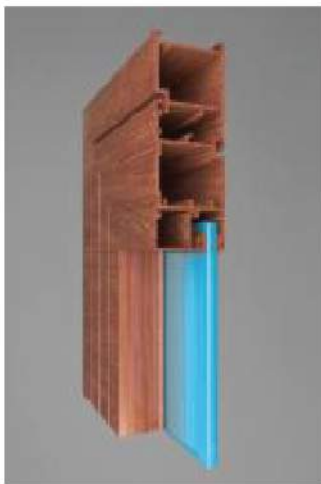
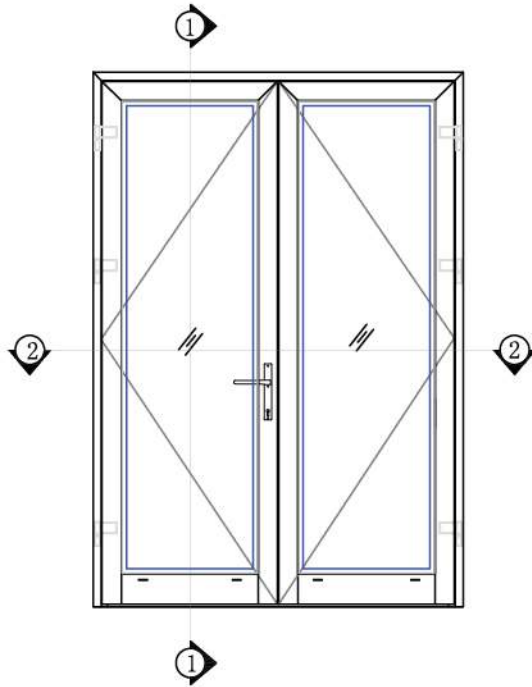

MẶT CẮT 1-1

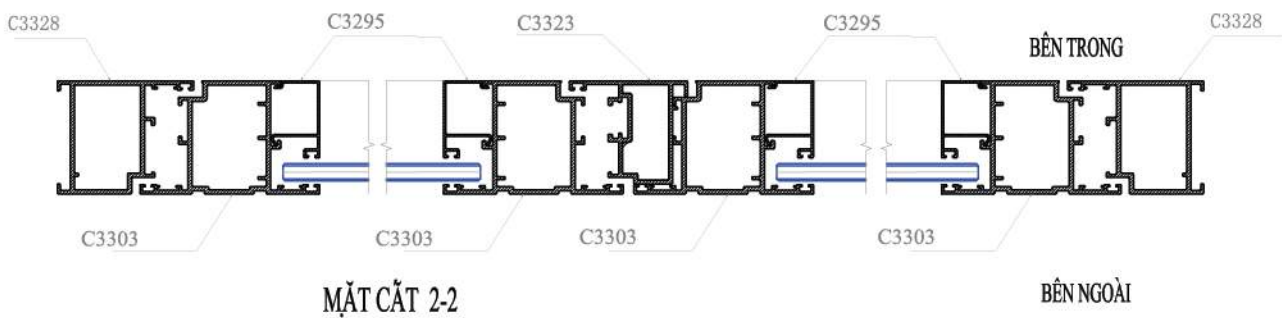

MẶT CẮT 2-2

LIST MẶT CẮT HỆ DY-56

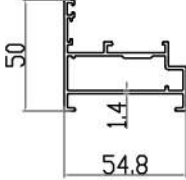
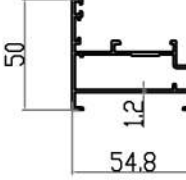
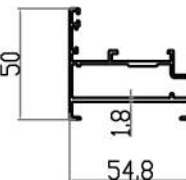
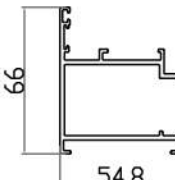
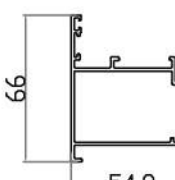
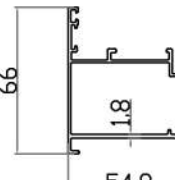
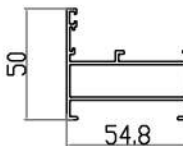
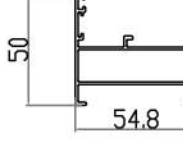
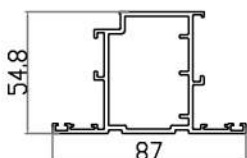
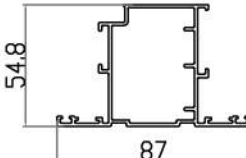
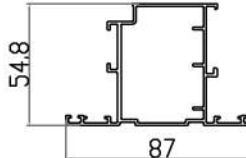
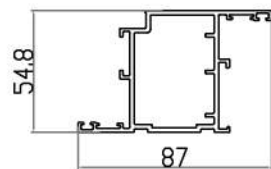
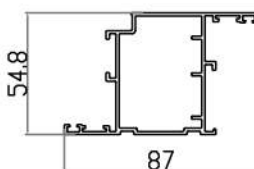
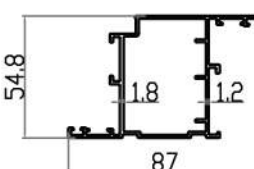
<p>Khung bao cửa sổ</p> 				<p>Khung bao cửa sổ</p> 				<p>Khung bao cửa sổ</p> 			
Mã mới	Mã cũ	Độ dày	Trọng lượng	Mã mới	Mã cũ	Độ dày	Trọng lượng	Mã mới	Mã cũ	Độ dày	Trọng lượng
DY330018140	C3318	1.4 mm	0.848 kg/m	DY330018120	XF3318A	1.2 mm	0.737 kg/m	DYG15220120	XF3318	1.2 mm	0.843 kg/m
<p>Khung bao cửa đi</p> 				<p>Khung bao cửa đi</p> 				<p>Khung bao cửa đi</p> 			
Mã mới	Mã cũ	Độ dày	Trọng lượng	Mã mới	Mã cũ	Độ dày	Trọng lượng	Mã mới	Mã cũ	Độ dày	Trọng lượng
DY330028200	C3328	2.0 mm	1.238 kg/m	DYG18437140M	THC-3328	1.4 mm	0.936 kg/m	DYG15224120	XF3328	1.2 mm	0.926 kg/m
<p>Khung vách cố định</p> 				<p>Khung vách cố định</p> 							
Mã mới	Mã cũ	Độ dày	Trọng lượng	Mã mới	Mã cũ	Độ dày	Trọng lượng	Mã mới	Mã cũ	Độ dày	Trọng lượng
DY330009140	C3209	1.4 mm	0.805 kg/m	DYG15217120	XF3209	1.2 mm	0.717 kg/m				
<p>Cánh cửa đi mở ngoài (T)</p> 				<p>Cánh cửa đi mở ngoài (T)</p> 				<p>Cánh cửa đi mở ngoài (T)</p> 			
Mã mới	Mã cũ	Độ dày	Trọng lượng	Mã mới	Mã cũ	Độ dày	Trọng lượng	Mã mới	Mã cũ	Độ dày	Trọng lượng
DY330013200	C3303	2.0 mm	1.457 kg/m	DYG18436140M1	THC-C3303M1	1.4 mm	1.139 kg/m	DYG15219120	XF3303	1.2 mm	1.078 kg/m
<p>Cánh cửa đi mở trong (z)</p> 				<p>Cánh cửa đi mở trong (z)</p> 				<p>Cánh cửa đi mở trong (z)</p> 			
Mã mới	Mã cũ	Độ dày	Trọng lượng	Mã mới	Mã cũ	Độ dày	Trọng lượng	Mã mới	Mã cũ	Độ dày	Trọng lượng
DY330032200	C3332	2.0 mm	1.457 kg/m	DY330032140M	THC-3332	1.4 mm	1.125 kg/m	DYG15221120	XF3332	1.2 mm	1.086 kg/m



LIST MẶT CẮT HỆ DY-56

Cánh cửa sổ				Cánh cửa sổ				Cánh cửa sổ			
Mã mới	Mã cũ	Độ dày	Trọng lượng	Mã mới	Mã cũ	Độ dày	Trọng lượng	Mã mới	Mã cũ	Độ dày	Trọng lượng
DY330012140	C3202	1.4 mm	1.116 kg/m	DYG15218120	XF3202	1.2 mm	1.066 kg/m	DY330012120	XF3202A	1.2 mm	0.971 kg/m
Cánh cửa sổ				Cánh cửa sổ nổi				Cánh cửa sổ nổi			
Mã mới	Mã cũ	Độ dày	Trọng lượng	Mã mới	Mã cũ	Độ dày	Trọng lượng	Mã mới	Mã cũ	Độ dày	Trọng lượng
DYG18049100M1	THC-3202M1	1.0 mm	0.915 kg/m	DY950000140	C2912	1.40 mm	1.145 kg/m	DY950003140	C3312A	1.40 mm	1.131 kg/m
Cánh cửa sổ (cải tiến)				Cánh cửa sổ (cải tiến)				Đổ động cửa sổ			
Mã mới	Mã cũ	Độ dày	Trọng lượng	Mã mới	Mã cũ	Độ dày	Trọng lượng	Mã mới	Mã cũ	Độ dày	Trọng lượng
DYL5602-3	C3202A	1.4 mm	1.093 kg/m	DYL5602-2	C3202B	1.2 mm	0.957 kg/m	DY330033140	C3033	1.4 mm	0.828 kg/m
Đổ động				Đổ động				Đổ động cửa sổ			
Mã mới	Mã cũ	Độ dày	Trọng lượng	Mã mới	Mã cũ	Độ dày	Trọng lượng	Mã mới	Mã cũ	Độ dày	Trọng lượng
DYG18462120M	THC-3323A	1.2 mm	0.795 kg/m	DYG18482180M	THC-3323B	1.8 mm	1.099 kg/m	DY330033120	XF3033	1.2 mm	0.732 kg/m
Đổ động cửa đi				Đổ động cửa đi				Đổ động cửa đi			
Mã mới	Mã cũ	Độ dày	Trọng lượng	Mã mới	Mã cũ	Độ dày	Trọng lượng	Mã mới	Mã cũ	Độ dày	Trọng lượng
DY330023180	C3323	1.8 mm	1.064 kg/m	DY330023120	XF3323	1.2 mm	0.756 kg/m	DYM5613-2		1.2 mm	0.794 kg/m

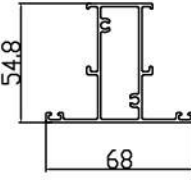
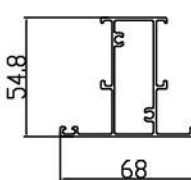
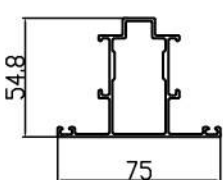
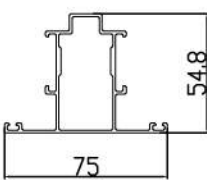
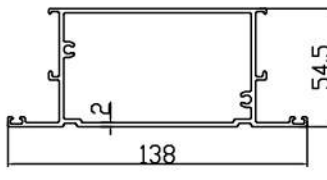
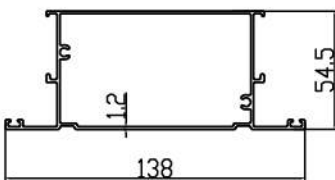
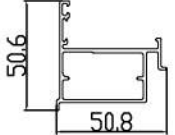
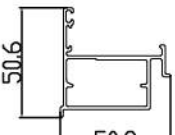
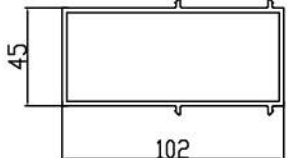
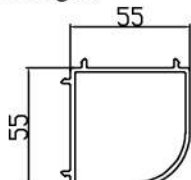
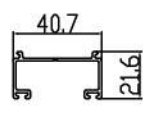
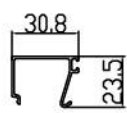
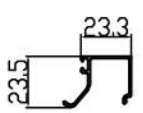
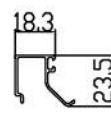
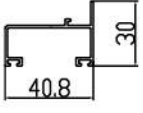
LIST MẶT CẮT HỆ DY-56

Đố T dùng cho vách kính 				Đố T dùng cho vách kính 				Đố T dùng cho khung bao 			
Mã mới	Mã cũ	Độ dày	Trọng lượng	Mã mới	Mã cũ	Độ dày	Trọng lượng	Mã mới	Mã cũ	Độ dày	Trọng lượng
DY330003140	C3203	1.4 mm	0.953 kg/m	DYG15215120	XF3203	1.2 mm	0.862 kg/m	DY950005140	C3313	1.4 mm	1.007 kg/m
Đố T dùng cho khung bao 				Đố ngang / ngang cánh dưới 				Đố ngang / ngang cánh dưới 			
Mã mới	Mã cũ	Độ dày	Trọng lượng	Mã mới	Mã cũ	Độ dày	Trọng lượng	Mã mới	Mã cũ	Độ dày	Trọng lượng
DYG15223120	XF3313	1.2 mm	0.906 kg/m	DY330004200	C3304	2.0 mm	2.031 kg/m	DYG15216120	XF3304	1.2 mm	1.335 kg/m
Thanh chuyển hèm vách 				Thanh chuyển hèm vách 				Cây hộp nối khung 			
Mã mới	Mã cũ	Độ dày	Trọng lượng	Mã mới	Mã cũ	Độ dày	Trọng lượng	Mã mới	Mã cũ	Độ dày	Trọng lượng
DY950018000	C3208	1.4 mm	0.762 kg/m	DY950018120	XF3208	1.2 mm	0.685 kg/m	DY330001200	C3740	2.0 mm	1.646 kg/m
Cây nối khung 90° 				Quét sàn 				Sập khung bao kính đơn 			
Mã mới	Mã cũ	Độ dày	Trọng lượng	Mã mới	Mã cũ	Độ dày	Trọng lượng	Mã mới	Mã cũ	Độ dày	Trọng lượng
DY330002200	C3326	2.0 mm	1.187 kg/m	DY330029120	XF3329	1.2 mm	0.361 kg/m	DY950001100	C3296	1.0 mm	0.238 kg/m
Sập cánh kính hộp 				Sập khung bao kính hộp 				Quét sàn 			
Mã mới	Mã cũ	Độ dày	Trọng lượng	Mã mới	Mã cũ	Độ dày	Trọng lượng	Mã mới	Mã cũ	Độ dày	Trọng lượng
DY330093100	C3286	1.0 mm	0.225 kg/m	DY330094100	C3225	1.0 mm	0.213 kg/m	DYG18833120M	THC-3329A	1.2 mm	0.376 kg/m

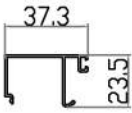
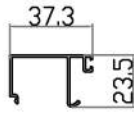
LIST MẶT CẮT HỆ DY-56

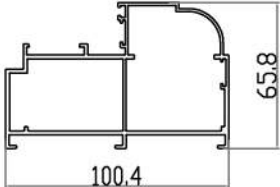
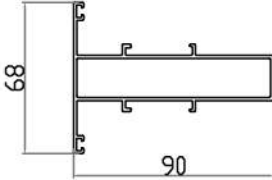
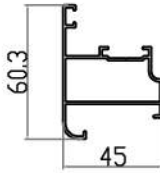
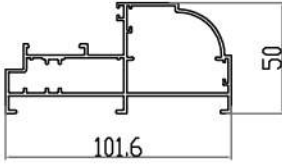
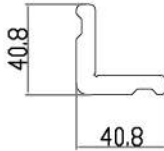
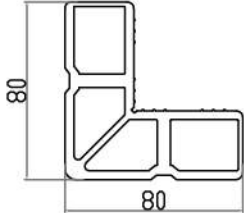
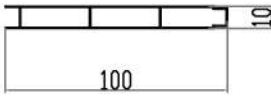
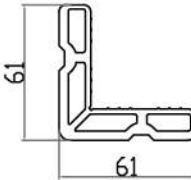
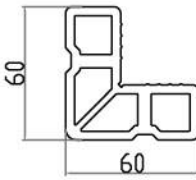
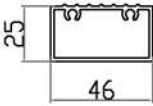
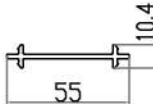
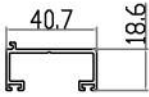
Sập cánh kính đơn 				Sập cánh kính đơn 				Thanh truyền động 			
Mã mới	Mã cũ	Độ dày	Trọng lượng	Mã mới	Mã cũ	Độ dày	Trọng lượng	Mã mới	Mã cũ	Độ dày	Trọng lượng
DY330095100	C3295	1.0 mm	0.272 kg/m	DYM5634-1		1.0 mm	0.272 kg/m	DY330059000	C459		0.139 kg/m
Khung bao 100 				Cây (T) tăng cứng 				Cánh cửa sổ nổi 			
Mã mới	Mã cũ	Độ dày	Trọng lượng	Mã mới	Mã cũ	Độ dày	Trọng lượng	Mã mới	Mã cũ	Độ dày	Trọng lượng
DYG17606130M		1.3 mm	.745 kg/m	DY950007140	C3234	1.4 mm	1.15 kg/m	DYG15670120	C3312B	1.2 mm	0.671 kg/m
Khung bao 100 				Ke góc khung lật khuôn 				Ke góc cửa đi 			
Mã mới	Mã cũ	Độ dày	Trọng lượng	Mã mới	Mã cũ	Độ dày	Trọng lượng	Mã mới	Mã cũ	Độ dày	Trọng lượng
DYG19451140	THC-2026	1.4 mm	1.418 kg/m	DY950006000	C107	8.7 mm	1.559 kg/m	DY330048400	F347A	4.0 mm	4.401 kg/m
Lá hộp phẳng 				Ke góc khung bao cửa sổ 				Ke góc cánh cửa sổ 			
Mã mới	Mã cũ	Độ dày	Trọng lượng	Mã mới	Mã cũ	Độ dày	Trọng lượng	Mã mới	Mã cũ	Độ dày	Trọng lượng
DY510004050	5104A	0.5 mm	0.324 kg/m	DY330088000	C1687A	1.4 mm	2.295 kg/m	DY330097400	C1697	4.0 mm	3.093 kg/m
Quét sàn 				Cây nối khung 				Quét sàn 			
Mã mới	Mã cũ	Độ dày	Trọng lượng	Mã mới	Mã cũ	Độ dày	Trọng lượng	Mã mới	Mã cũ	Độ dày	Trọng lượng
DY330019160	C3319	1.6 mm	0.692 kg/m	DY330000200	C3300	2.0 mm	0.384 kg/m	DY330029180	C3329	1.8 mm	0.428 kg/m
DY330019120	XF3319	1.2 mm	0.542 kg/m	DY330000120	XF3300	1.2 mm	0.225 kg/m	DYM5609-2		1.2 mm	0.333 kg/m

HỆ NỘI THẤT DY-51

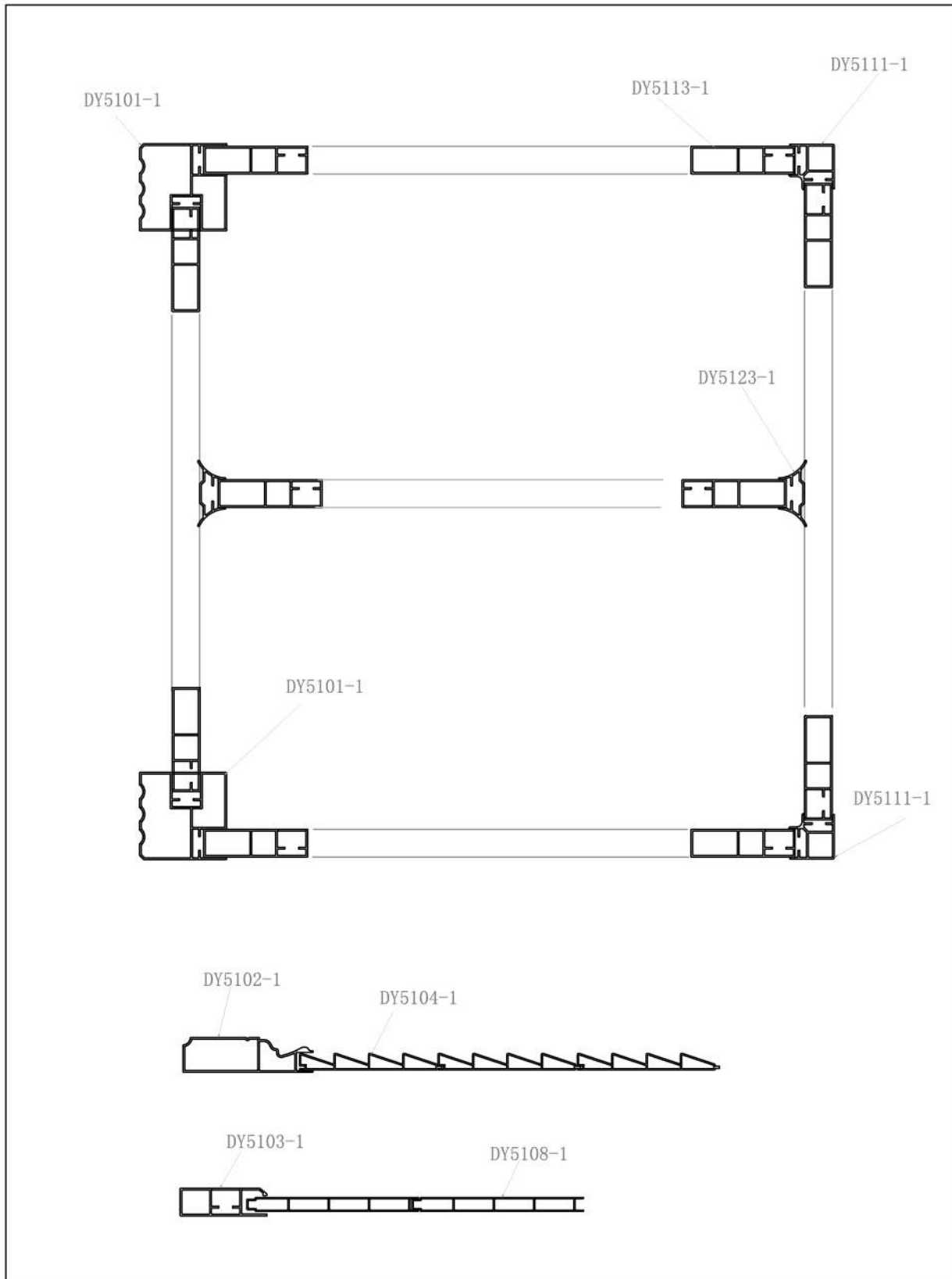

LIST MẶT CẮT HỆ NỘI THẤT DY-51

TRỤ TRƯỚC 				CÁNH TỬ 				KHUNG VÁCH 			
Mã mới	Mã cũ	Độ dày	Trọng lượng	Mã mới	Mã cũ	Độ dày	Trọng lượng	Mã mới	Mã cũ	Độ dày	Trọng lượng
DY5101-1		1.0 mm	0.820 kg/m	DY5102-1		1.0 mm	0.555 kg/m	DY5103-1		1.0 mm	0.414 kg/m
LÁ CHÓP 				LÁ HỘP NHỎ 				PHÀO NÓC TỬ 			
Mã mới	Mã cũ	Độ dày	Trọng lượng	Mã mới	Mã cũ	Độ dày	Trọng lượng	Mã mới	Mã cũ	Độ dày	Trọng lượng
DY5104-1		0.7 mm	0.392 kg/m	DY5108-1		0.7 mm	0.438 kg/m	DY5109-1		1.0 mm	0.708 kg/m
TRỤ SAU 				CÂY LIÊN KẾT 				LÁ HỘP TO 			
Mã mới	Mã cũ	Độ dày	Trọng lượng	Mã mới	Mã cũ	Độ dày	Trọng lượng	Mã mới	Mã cũ	Độ dày	Trọng lượng
DY5111-1		1.0 mm	0.318 kg/m	DY5113-1		1.0 mm	0.495 kg/m	DY5118-1		1.0 mm	0.726 kg/m
PHÀO BÀN TỬ 				BÁT CHIA NGĂN 				U 16 			
Mã mới	Mã cũ	Độ dày	Trọng lượng	Mã mới	Mã cũ	Độ dày	Trọng lượng	Mã mới	Mã cũ	Độ dày	Trọng lượng
DY5119-1		1.0 mm	0.336 kg/m	DY5123-1		1.0 mm	0.211 kg/m	DY5133-1		0.8 mm	0.105 kg/m
				TRỤ NHỎ 				THANH NGĂN KÉO 			
Mã mới	Mã cũ	Độ dày	Trọng lượng	Mã mới	Mã cũ	Độ dày	Trọng lượng	Mã mới	Mã cũ	Độ dày	Trọng lượng
				DY5131-1		1.0 mm	0.579 kg/m	DY5121-1		0.8 mm	0.148 kg/m

HỆ CỬA DY-172

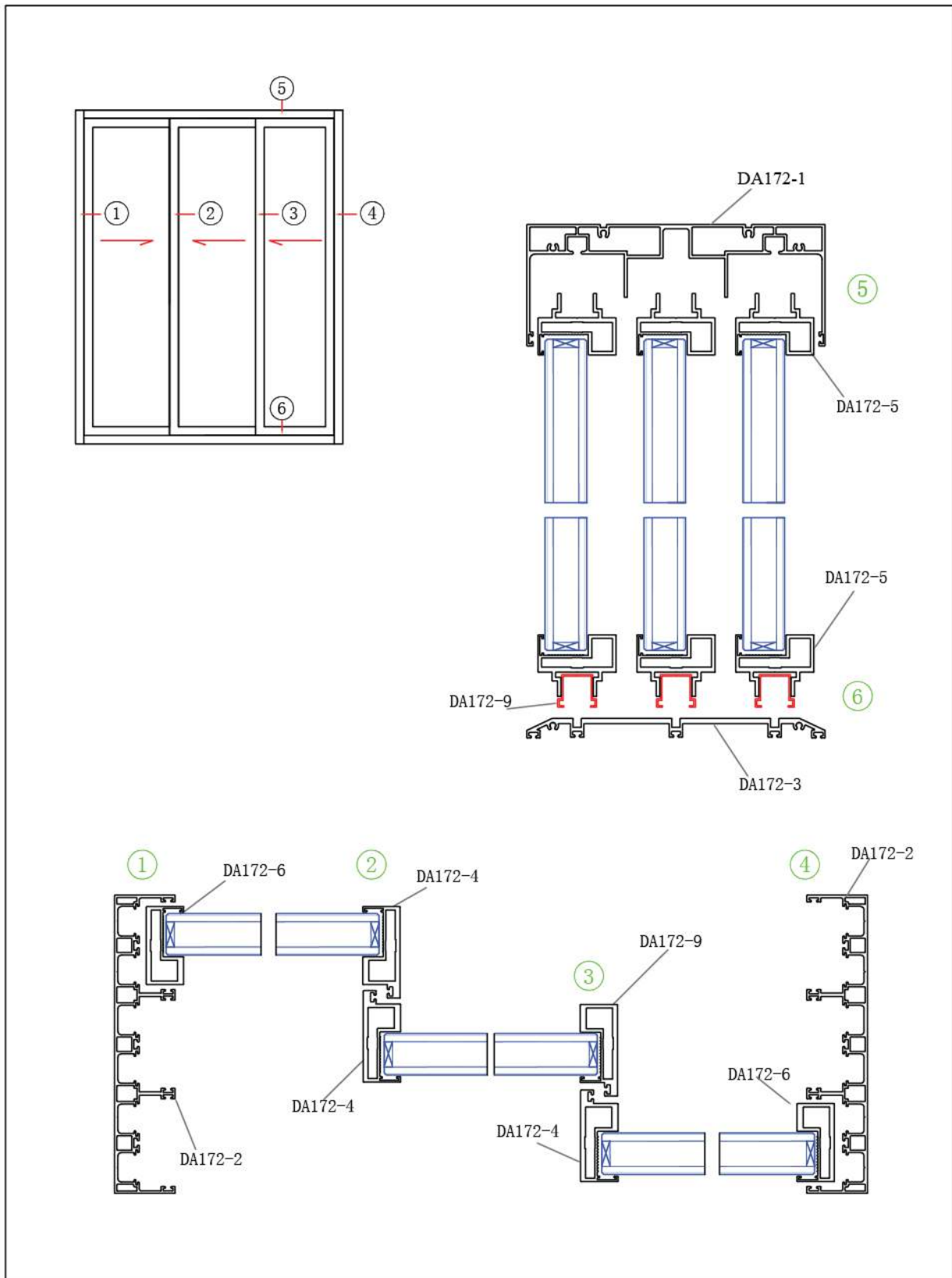

LIST MẶT CẮT HỆ CỬA LỬA DY-172

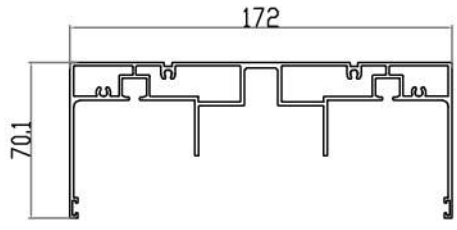
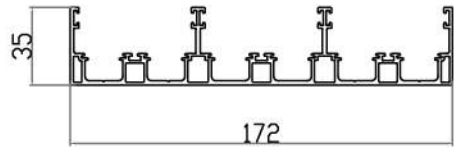
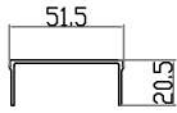
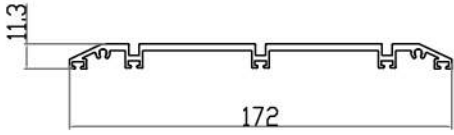
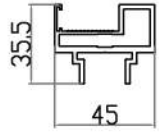
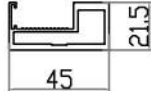
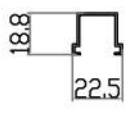
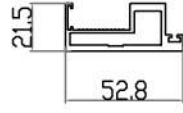
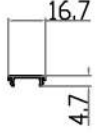
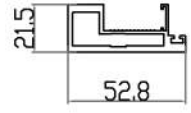
											
Mã mới	Mã cũ	Độ dày	Trọng lượng	Mã mới	Mã cũ	Độ dày	Trọng lượng				
DYG20282170	DA172-1	1.7	2.895 kg/m	DYG20283135	DA172-2	1.35 mm	2.305 kg/m				
											
Mã mới	Mã cũ	Độ dày	Trọng lượng	Mã mới	Mã cũ	Độ dày	Trọng lượng				
DYG20285125	DA172-7	1.25 mm	0.326 kg/m	DYG20284300	DA172-3	3.0 mm	1.645 kg/m				
											
Mã mới	Mã cũ	Độ dày	Trọng lượng	Mã mới	Mã cũ	Độ dày	Trọng lượng	Mã mới	Mã cũ	Độ dày	Trọng lượng
DYG20289200	DA172-5	2.0 mm	0.945 kg/m	DYG20290200	DA172-6	2.0	0.809	DYG20288100	DA172-9	1.0	0.17
											
Mã mới	Mã cũ	Độ dày	Trọng lượng	Mã mới	Mã cũ	Độ dày	Trọng lượng	Mã mới	Mã cũ	Độ dày	Trọng lượng
DYG20287200	DA172-4	2.00	0.928	DYG20286100	DA172-8	1.0	0.071	DYG20468200	DA172-9	2.0	0.928
Mã mới	Mã cũ	Độ dày	Trọng lượng	Mã mới	Mã cũ	Độ dày	Trọng lượng	Mã mới	Mã cũ	Độ dày	Trọng lượng

HỆ CỬA LỬA DY-48 : 48A

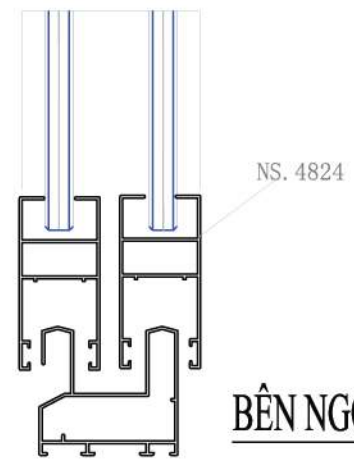
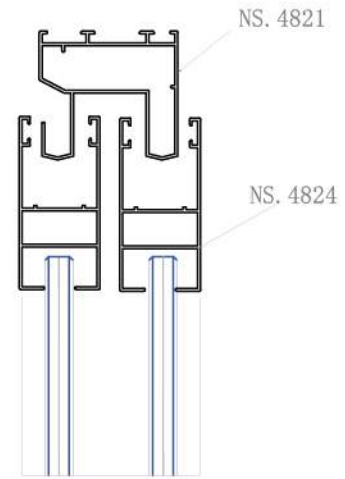
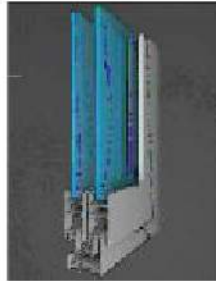
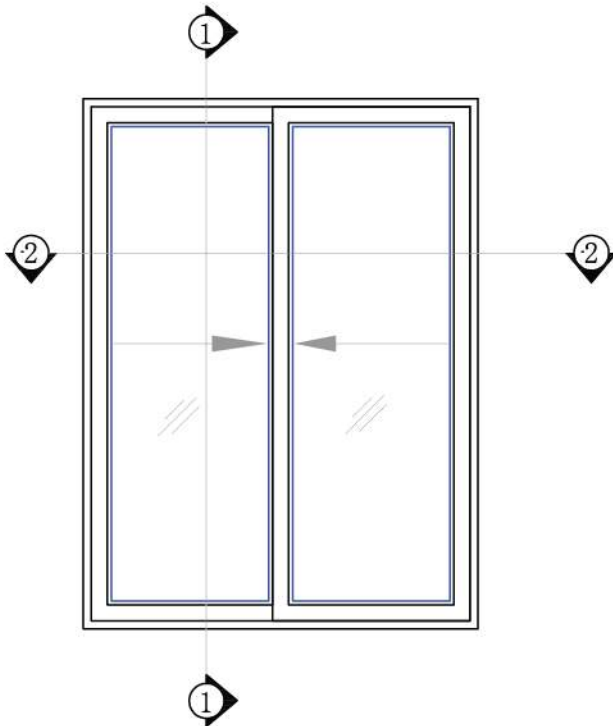

BÊN TRONG

BÊN NGOÀI

MẶT CẮT 2-2

BÊN TRONG

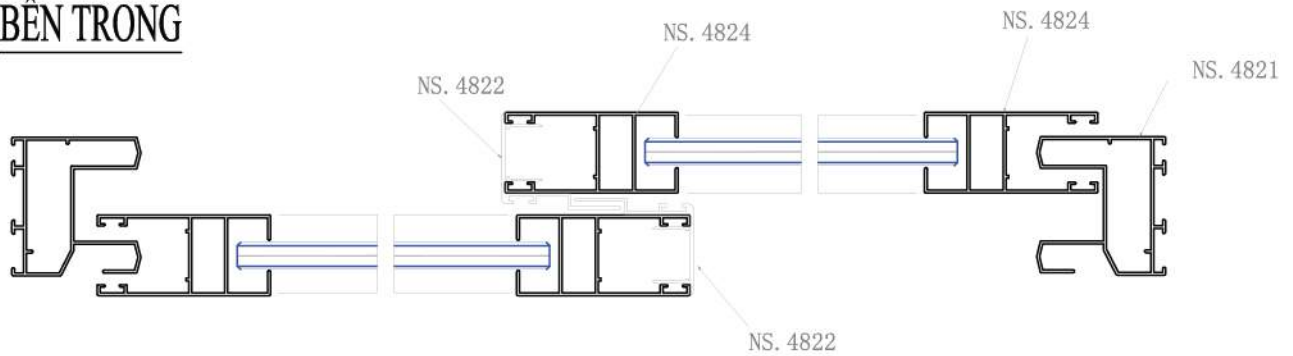

BÊN NGOÀI

MẶT CẮT 2-2

LIST MẶT CẮT HỆ CỬA LÙA DY-48: 48A

RAY				MÓC CÁNH				CÁNH LÙA			
Mã mới	Mã cũ	Độ dày	Trọng lượng	Mã mới	Mã cũ	Độ dày	Trọng lượng	Mã mới	Mã cũ	Độ dày	Trọng lượng
DY480001100	NS.4821	1.0 mm	0.654 kg/m	DY480006100	NS.4822	1.0 mm	0.305 kg/m	DY480004100	NS.4824	1.0 mm	0.555 kg/m
ĐỐI ĐẦU 4 CÁNH											
Mã mới	Mã cũ	Độ dày	Trọng lượng	Mã mới	Mã cũ	Độ dày	Trọng lượng	Mã mới	Mã cũ	Độ dày	Trọng lượng
DY480008100	NS.4823	1.0 mm	0.23 kg/m								
LIST MẶT CẮT HỆ CỬA LÙA DY-48A											
RAY				MÓC CÁNH				CÁNH LÙA			
Mã mới	Mã cũ	Độ dày	Trọng lượng	Mã mới	Mã cũ	Độ dày	Trọng lượng	Mã mới	Mã cũ	Độ dày	Trọng lượng
DYG17803130	NS.4821A	1.3 mm	0.71 kg/m	DYG17801120	NS.4822A	1.2 mm	0.33 kg/m	DYG17802130	NS.4824A	1.3 mm	0.681 kg/m
ĐỐI ĐẦU 4 CÁNH											
Mã mới	Mã cũ	Độ dày	Trọng lượng	Mã mới	Mã cũ	Độ dày	Trọng lượng	Mã mới	Mã cũ	Độ dày	Trọng lượng
DYG17856130	NS.4823A	1.3 mm	0.347 kg/m								

HỆ CỬA LỬA DY-55A

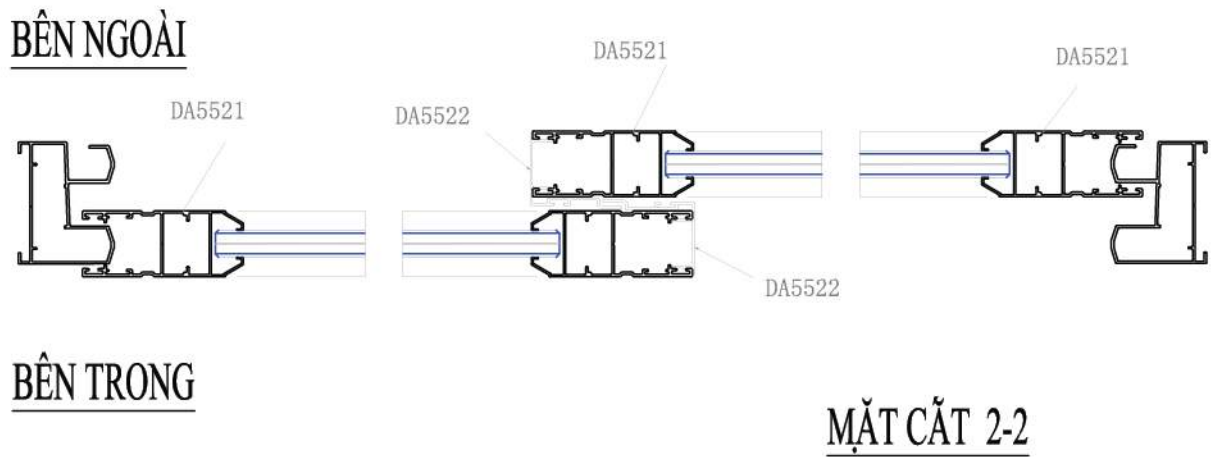
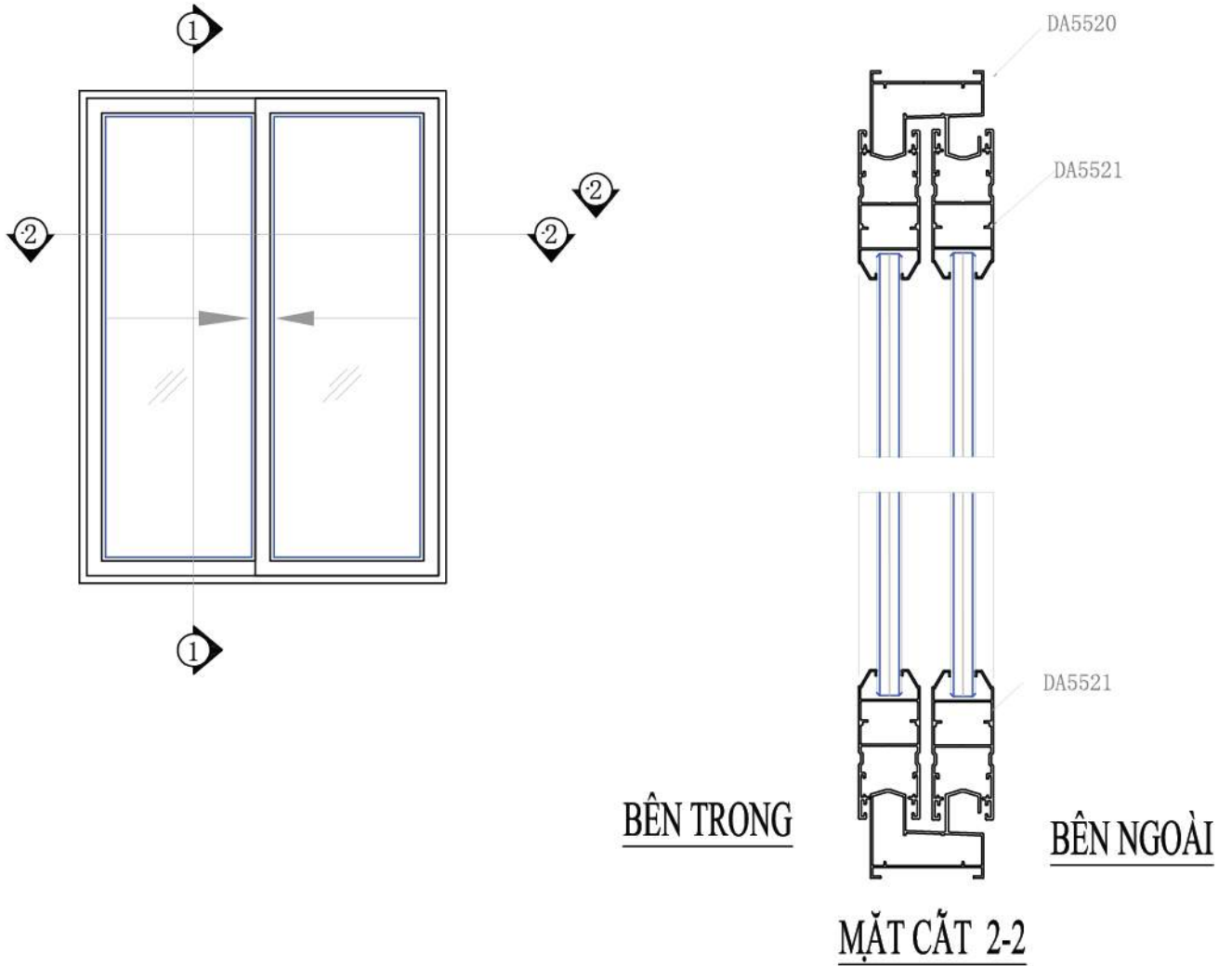

LIST MẶT CẮT HỆ CỬA LỬA DY-55A

RAY				MÓC CÁNH				CÁNH LỬA			
Mã mới	Mã cũ	Độ dày	Trọng lượng	Mã mới	Mã cũ	Độ dày	Trọng lượng	Mã mới	Mã cũ	Độ dày	Trọng lượng
DY552020110C	DA5520	1.1 mm	0.711 kg/m	DY552022100	DA5522	1.0 mm	0.289 kg/m	DY552021100	DA5521	1.0 mm	0.682 kg/m
ĐÓI ĐẦU 4 CÁNH				CHẶN NƯỚC							
Mã mới	Mã cũ	Độ dày	Trọng lượng	Mã mới	Mã cũ	Độ dày	Trọng lượng	Mã mới	Mã cũ	Độ dày	Trọng lượng
DY552023100	DA5523	1.0 mm	0.337 kg/m	DY552023100	DA5524	1.0 mm	0.136 kg/m				
<h2>LIST HỆ LỬA DY-50</h2>											
Ray cửa lửa				Cánh cửa lửa				Móc cửa lửa			
Mã mới	Mã cũ	Độ dày	Trọng lượng	Mã mới	Mã cũ	Độ dày	Trọng lượng	Mã mới	Mã cũ	Độ dày	Trọng lượng
DY500006115	5006	1.15 mm	0.741 kg/m	DY500002115	5002	1.15 mm	0.744 kg/m	DY500003115	5003	1.15 mm	0.344 kg/m
Hèm H cửa 4 cánh											
Mã mới	Mã cũ	Độ dày	Trọng lượng	Mã mới	Mã cũ	Độ dày	Trọng lượng	Mã mới	Mã cũ	Độ dày	Trọng lượng
DY500001120	5001	1.2 mm	0.375 kg/m								

LIST MẶT CẮT HỆ CỬA LỬA DY-55-THC

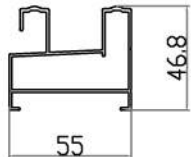
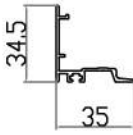
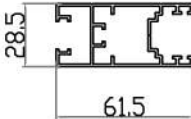
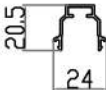
RAY				MÓC CẢNH				CẢNH LỬA			
											
Mã mới	Mã cũ	Độ dày	Trọng lượng	Mã mới	Mã cũ	Độ dày	Trọng lượng	Mã mới	Mã cũ	Độ dày	Trọng lượng
DYG18427120M	THC-5551	1.2 mm	0.82 kg/m	DYG18430120M	THC-5553	1.2 mm	0.309 kg/m	DYG18428120M	THC-5552	1.2 mm	0.823 kg/m
ĐỐI ĐẦU 4 CẢNH											
											
Mã mới	Mã cũ	Độ dày	Trọng lượng	Mã mới	Mã cũ	Độ dày	Trọng lượng	Mã mới	Mã cũ	Độ dày	Trọng lượng
DYG18429110M	THC-5554	1.1 mm	0.196 kg/m								

LIST HỆ LỬA DY-55-VS

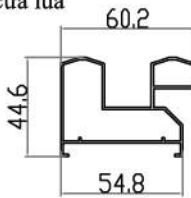
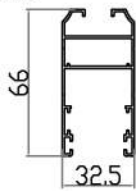
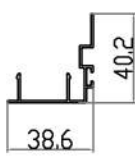
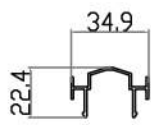
Ray cửa lửa				Cánh cửa lửa				Móc cửa lửa			
											
Mã mới	Mã cũ	Độ dày	Trọng lượng	Mã mới	Mã cũ	Độ dày	Trọng lượng	Mã mới	Mã cũ	Độ dày	Trọng lượng
DYG18845105	DA5517-VS	1.05 mm	0.748 kg/m	DYG18846105	DA5566-VS	1.05 mm	0.709 kg/m	DYG18847100	DA55M-VS	1.0 mm	0.317 kg/m
ĐỐI ĐẦU 4 CẢNH											
											
Mã mới	Mã cũ	Độ dày	Trọng lượng	Mã mới	Mã cũ	Độ dày	Trọng lượng	Mã mới	Mã cũ	Độ dày	Trọng lượng
DYG18849110	DA55N-VS	1.1 mm	0.272 kg/m								

HỆ CỬA LỬA 4 CẢNH DY - 93

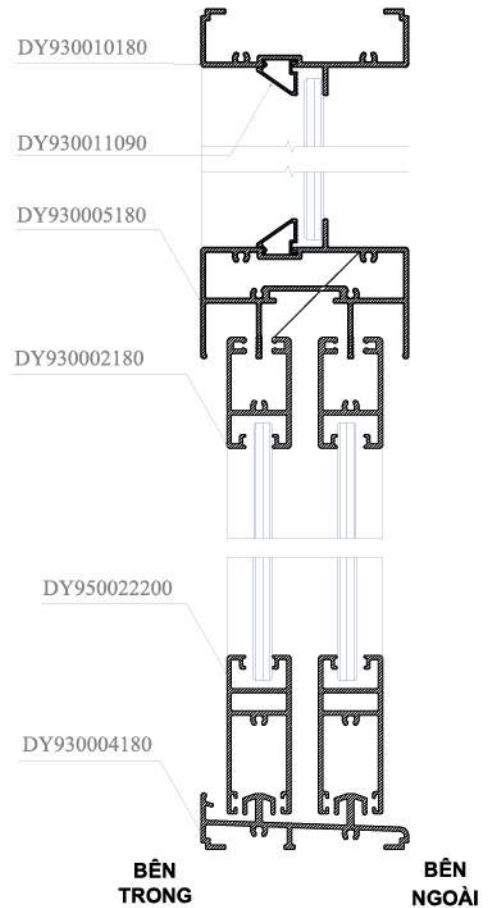
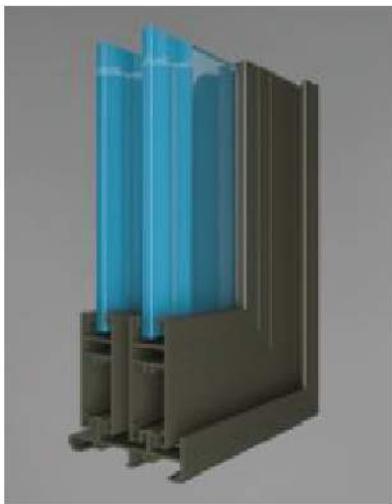
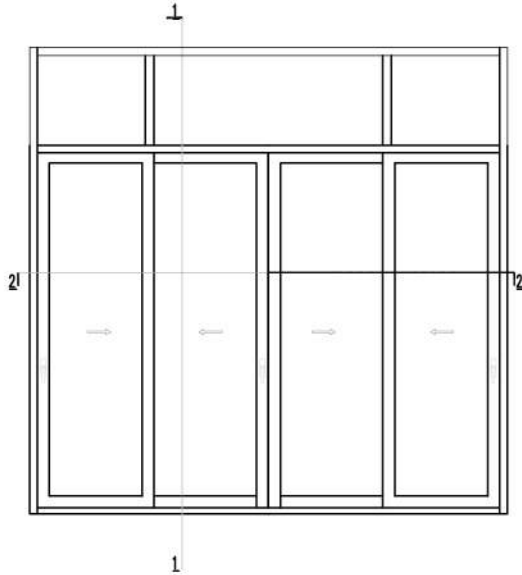

MẶT CẮT 1-1

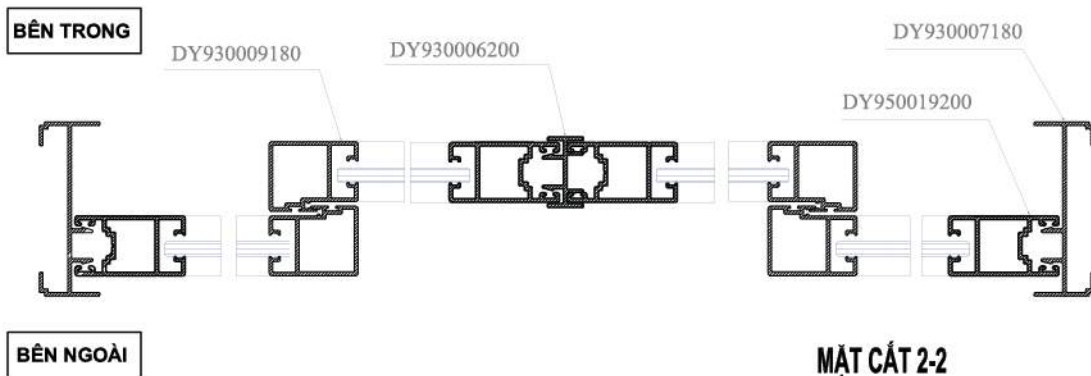

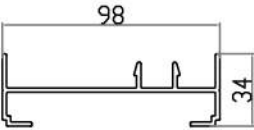
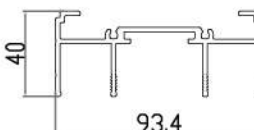
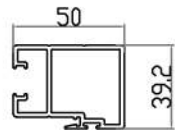
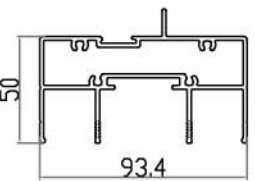
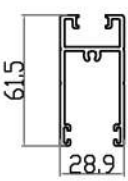
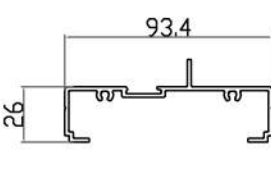
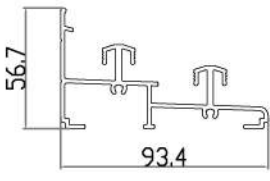
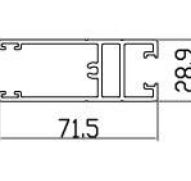
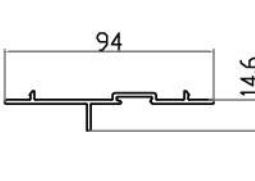
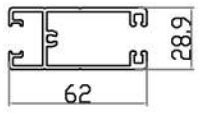
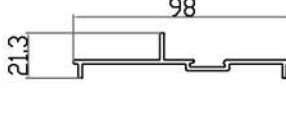
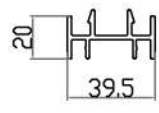
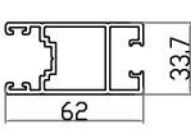
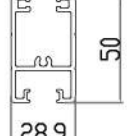
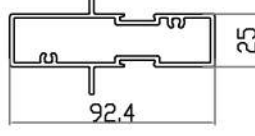
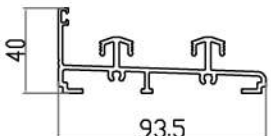
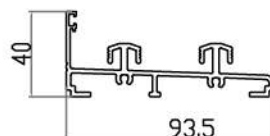
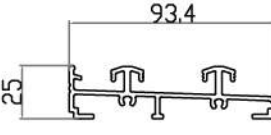

MẶT CẮT 2-2

LIST MẶT CẮT HỆ DY-93

											
Mã mới	Mã cũ	Độ dày	Trọng lượng	Mã mới	Mã cũ	Độ dày	Trọng lượng	Mã mới	Mã cũ	Độ dày	Trọng lượng
DY930007200	D1543	2.0 mm	1.149 kg/m	DY930001200	D1541	2.0 mm	1.475 kg/m	DY930009200	D1547	2.0 mm	1.111 kg/m
DY930007180	D1543A	1.8 mm	1.035 kg/m	DY930001180	D1541A	1.8 mm	1.342 kg/m	DY930009180	D1547A	1.8 mm	1.009 kg/m
DYG15242120	XF1543	1.2 mm	0.73 kg/m	DYG15245120	XF1541	1.2 mm	0.986 kg/m	DYG15240120	XF1547	1.2 mm	0.719 kg/m
											
Mã mới	Mã cũ	Độ dày	Trọng lượng	Mã mới	Mã cũ	Độ dày	Trọng lượng	Mã mới	Mã cũ	Độ dày	Trọng lượng
DY930005180	D1551A	1.8 mm	1.988 kg/m	DY930014200	D1545	2.0 mm	1.009 kg/m	DY930010180	D1559A	1.8 mm	0.989 kg/m
DYG15246120	XF1551	1.2 mm	1.478 kg/m	DY930014120	XF1545C	1.2 mm	0.666 kg/m	DYG15239120	XF1559	1.2 mm	0.73 kg/m
											
Mã mới	Mã cũ	Độ dày	Trọng lượng	Mã mới	Mã cũ	Độ dày	Trọng lượng	Mã mới	Mã cũ	Độ dày	Trọng lượng
DY930015180	D1542	1.8 mm	1.588 kg/m	DY950022200	D1555A	2.0 mm	1.247 kg/m	DY930013180	D1578	1.8 mm	0.603 kg/m
DY930015120	XF1542	1.2 mm	1.13 kg/m	DY950022120	XF1555A	1.2 mm	0.828 kg/m	DY930013120	XF1578	1.2 mm	0.403 kg/m
											
Mã mới	Mã cũ	Độ dày	Trọng lượng	Mã mới	Mã cũ	Độ dày	Trọng lượng	Mã mới	Mã cũ	Độ dày	Trọng lượng
DY930003180	D1555	1.8 mm	1.044 kg/m	DY930012180	D1549A	1.8 mm	0.646 kg/m	DY930006200	D1548A	2.0 mm	0.622 kg/m
DYG15243120	XF1545	1.2 mm	0.769 kg/m	DY930012120	XF1549	1.2 mm	0.437 kg/m	DY930006120	XF1548	1.2 mm	0.396 kg/m
											
Mã mới	Mã cũ	Độ dày	Trọng lượng	Mã mới	Mã cũ	Độ dày	Trọng lượng	Mã mới	Mã cũ	Độ dày	Trọng lượng
DY950019200	D1546A	2.0 mm	1.277 kg/m	DY930002200	D1544	2.0 mm	0.992 kg/m	DY950021200	D2618	2.0 mm	1.554 kg/m
DY930008180	D1546	1.8 mm	1.184 kg/m	DY930002180	D1544A	1.8 mm	0.926 kg/m	DY940029180	MR201	1.8 mm	1.411 kg/m
DYG15241120	XF1546	1.2 mm	0.839 kg/m	DYG15244120	XF1544	1.2 mm	0.691 kg/m	DYG15238120	XF2618	1.2 mm	1.023 kg/m
											
Mã mới	Mã cũ	Độ dày	Trọng lượng	Mã mới	Mã cũ	Độ dày	Trọng lượng	Mã mới	Mã cũ	Độ dày	Trọng lượng
DY9300024200	D1942B	2.0 mm	1.439 kg/m	DYG17996200M	MH-9301	2.0 mm	1.488 kg/m	DY930004200	D1942	2.0 mm	1.402 kg/m
								DY930004180	D1942A	1.8 mm	1.284 kg/m
								DY930004120	XF1942	1.2 mm	0.913 kg/m

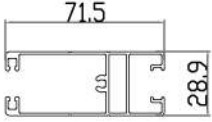
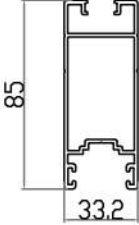
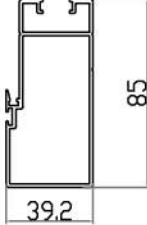
LIST MẶT CẮT HỆ DY-93

											
Mã mới	Mã cũ	Độ dày	Trọng lượng	Mã mới	Mã cũ	Độ dày	Trọng lượng	Mã mới	Mã cũ	Độ dày	Trọng lượng
DYG15247120	XF1555	1.2 mm	0.919 kg/m	DYG18825160	26146	1.6 mm	1.276 kg/m	DYG18826160	28127	1.6 mm	1.232 kg/m
											
Mã mới	Mã cũ	Độ dày	Trọng lượng	Mã mới	Mã cũ	Độ dày	Trọng lượng	Mã mới	Mã cũ	Độ dày	Trọng lượng
DY930011090	C101A	0.9 mm	0.124 kg/m								
Mã mới	Mã cũ	Độ dày	Trọng lượng	Mã mới	Mã cũ	Độ dày	Trọng lượng	Mã mới	Mã cũ	Độ dày	Trọng lượng
Mã mới	Mã cũ	Độ dày	Trọng lượng	Mã mới	Mã cũ	Độ dày	Trọng lượng	Mã mới	Mã cũ	Độ dày	Trọng lượng
Mã mới	Mã cũ	Độ dày	Trọng lượng	Mã mới	Mã cũ	Độ dày	Trọng lượng	Mã mới	Mã cũ	Độ dày	Trọng lượng

HỆ CỬA SỔ DY-88L

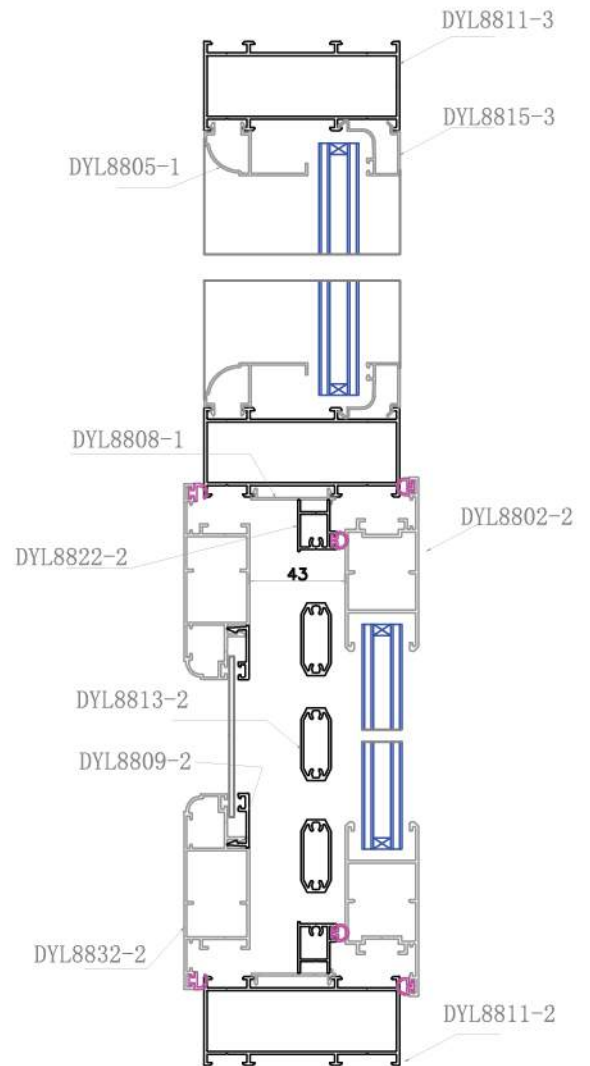
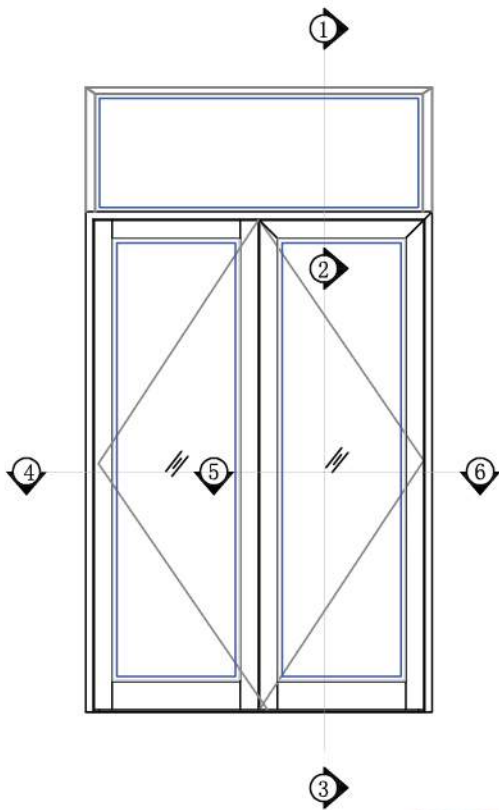

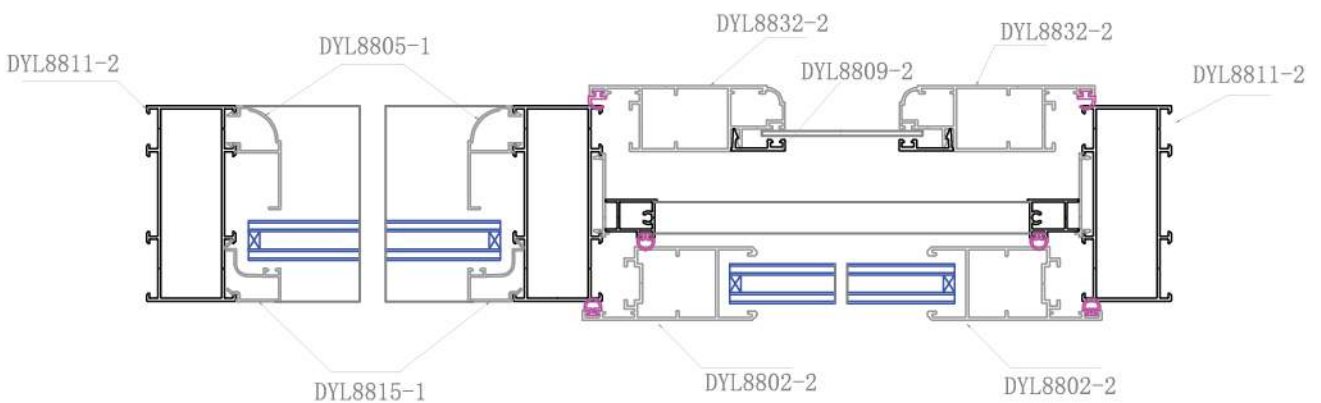

MẶT CẮT 1-2-3

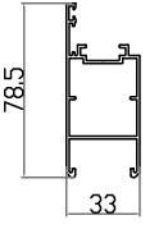
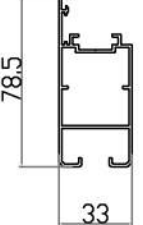
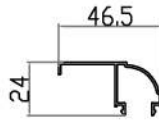
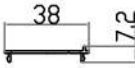

MẶT CẮT 4-5-6

LIST MẶT CẮT HỆ CỬA DY-88L

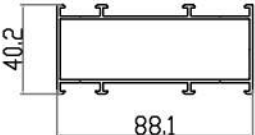
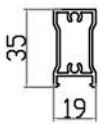
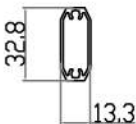
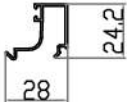
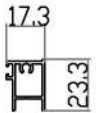
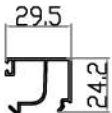
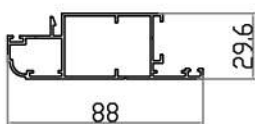
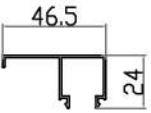
											
Mã mới	Mã cũ	Độ dày	Trọng lượng	Mã mới	Mã cũ	Độ dày	Trọng lượng	Mã mới	Mã cũ	Độ dày	Trọng lượng
DYL8802-2	THC-8805	1.3	0.841 kg/m	DYL8803-2	THC-8805A	1.3 mm	0.882 kg/m	DYL8805-1	THC-8807	1.0 mm	0.271 kg/m
											
Mã mới	Mã cũ	Độ dày	Trọng lượng	Mã mới	Mã cũ	Độ dày	Trọng lượng	Mã mới	Mã cũ	Độ dày	Trọng lượng
DYL8808-1	THC-8804	1.1 mm	0.143 kg/m	DYL8809-2	THC-8811	1.3 mm	0.158 kg/m	DYL8811-3	THC-8806	1.35 mm	1.072 kg/m
											
Mã mới	Mã cũ	Độ dày	Trọng lượng	Mã mới	Mã cũ	Độ dày	Trọng lượng	Mã mới	Mã cũ	Độ dày	Trọng lượng
DYL8812-3	THC-8801	1.4 mm	0.472 kg/m	DYL8813-2	THC-8803	1.15 mm	0.316 kg/m	DYL8815-1	THC-8808	0.9 mm	0.222 kg/m
											
Mã mới	Mã cũ	Độ dày	Trọng lượng	Mã mới	Mã cũ	Độ dày	Trọng lượng	Mã mới	Mã cũ	Độ dày	Trọng lượng
DYL8822-2	THC-8802	1.2 mm	0.274 kg/m	DYL8825-1	THC-8809	0.9 mm	0.274 kg/m	DYL8832-2	THC-8810	1.2 mm	0.889 kg/m
											
Mã mới	Mã cũ	Độ dày	Trọng lượng	Mã mới	Mã cũ	Độ dày	Trọng lượng	Mã mới	Mã cũ	Độ dày	Trọng lượng
DYL8835-1	THC-8807A	1.0 mm	0.288 kg/m								

HỆ CỬA SỔ DY-107L

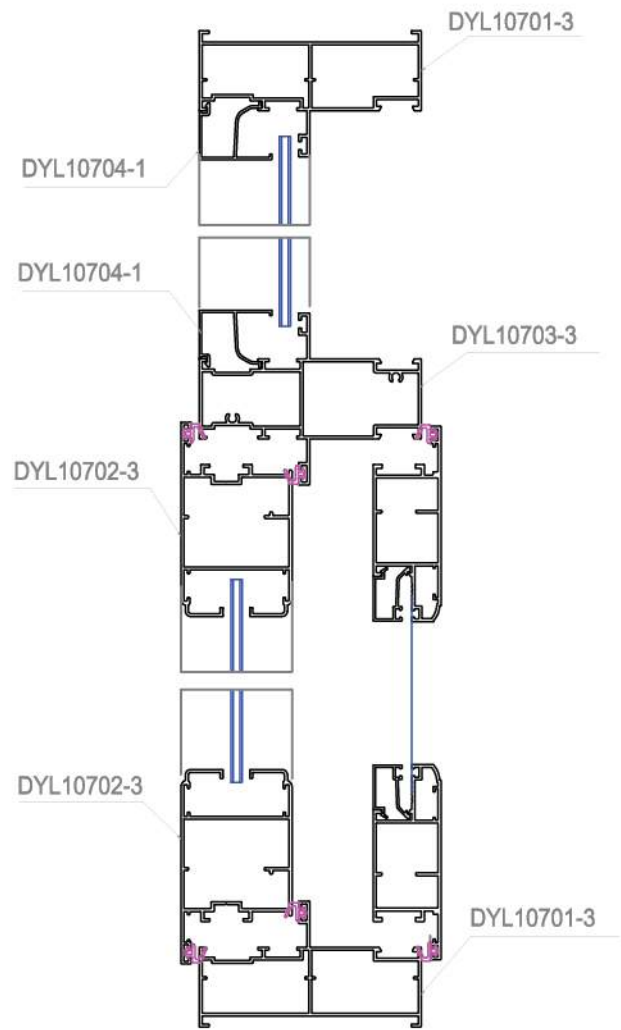
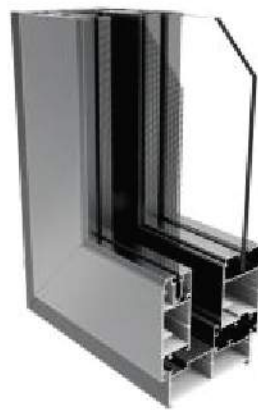
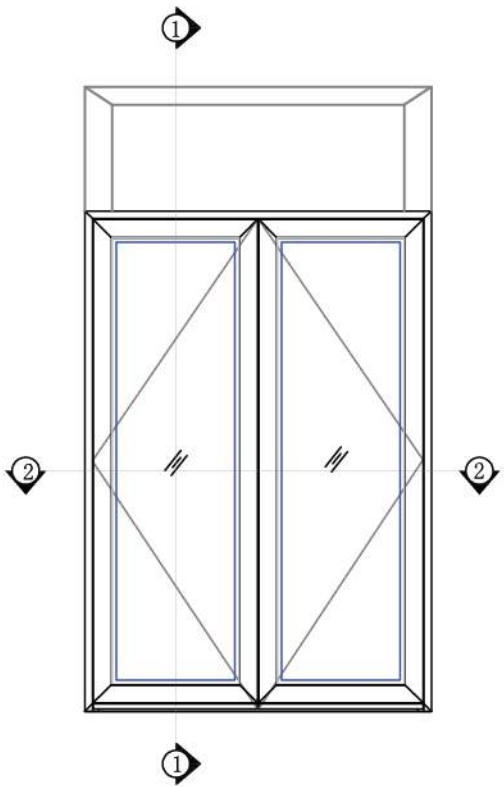

MẶT CẮT 1-1

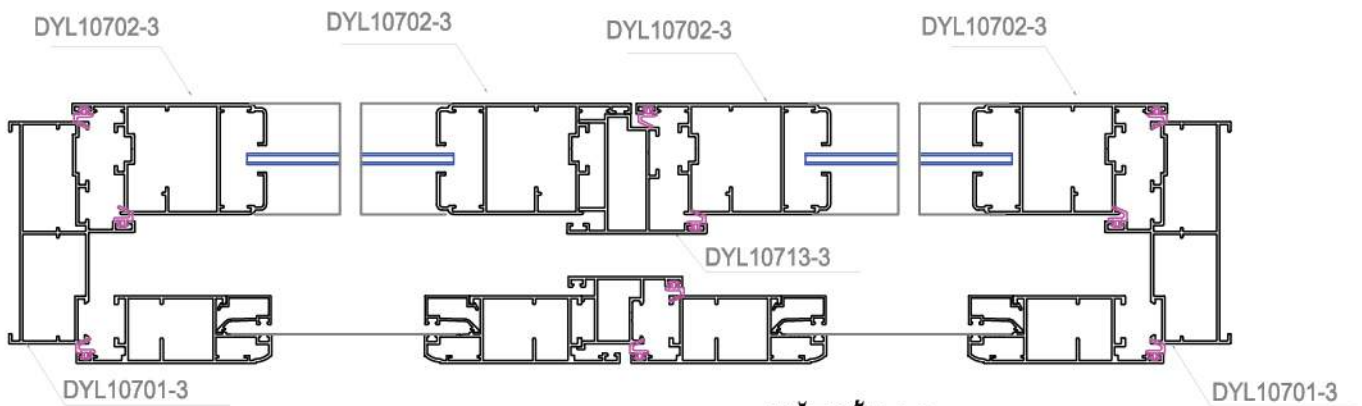

MẶT CẮT 2-2

LIST MẶT CẮT HỆ CỬA DY-107L

Mã mới	Mã cũ	Độ dày	Trọng lượng	Mã mới	Mã cũ	Độ dày	Trọng lượng	Mã mới	Mã cũ	Độ dày	Trọng lượng
DYL10701-3	THC-10704	1.35	1.306 kg/m	DYL10702-3	THC-10702	1.35 mm	1.241 kg/m	DYL10703-3	THC-10705	1.35 mm	1.522 kg/m
Mã mới	Mã cũ	Độ dày	Trọng lượng	Mã mới	Mã cũ	Độ dày	Trọng lượng	Mã mới	Mã cũ	Độ dày	Trọng lượng
DYL10704-1	THC-10707	1.1 mm	0.255 kg/m	DYL10705-1	THC-10706	1.1 mm	0.236 kg/m	DYL10712-3	THC-10701	1.35 mm	1.161 kg/m
Mã mới	Mã cũ	Độ dày	Trọng lượng	Mã mới	Mã cũ	Độ dày	Trọng lượng	Mã mới	Mã cũ	Độ dày	Trọng lượng
DYL10713-3	THC-10703	1.4 mm	0.921 kg/m	DYL10715-1	THC-10709	1.0 mm	0.199 kg/m	DYL10722-3	THC-10708	1.35 mm	1.004 kg/m
Mã mới	Mã cũ	Độ dày	Trọng lượng	Mã mới	Mã cũ	Độ dày	Trọng lượng	Mã mới	Mã cũ	Độ dày	Trọng lượng
Mã mới	Mã cũ	Độ dày	Trọng lượng	Mã mới	Mã cũ	Độ dày	Trọng lượng	Mã mới	Mã cũ	Độ dày	Trọng lượng

HỆ CỬA ĐI MỞ QUAY DY-66

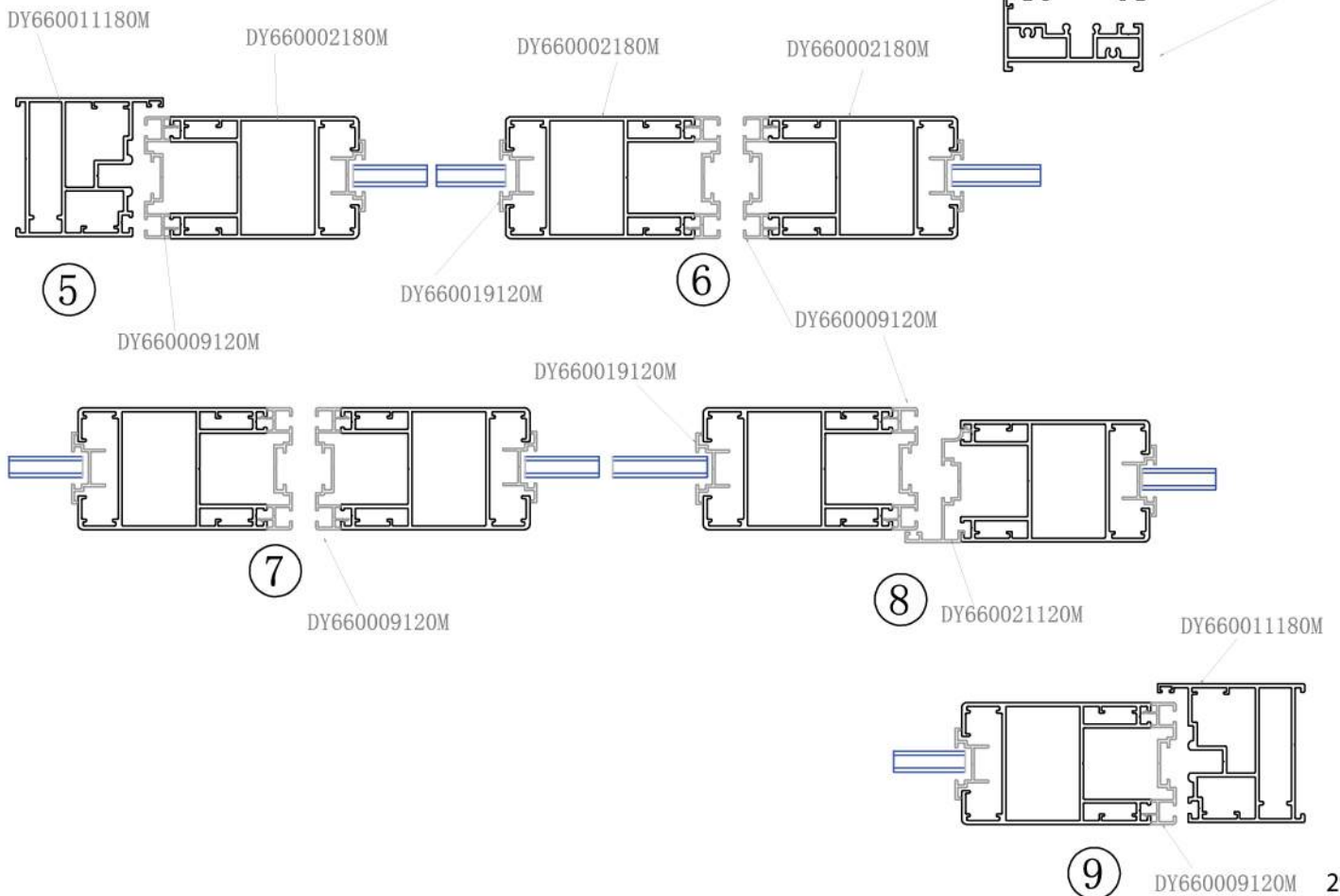
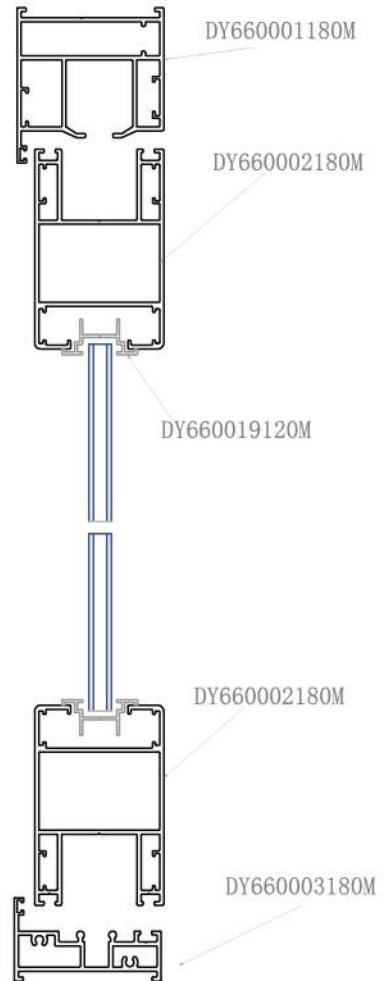
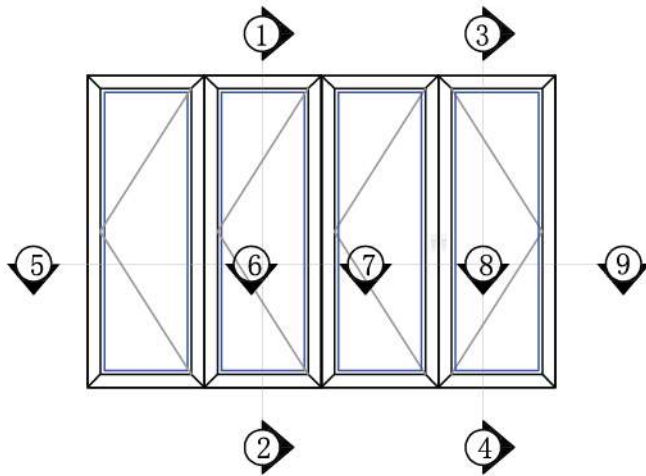

LIST MẶT CẮT HỆ DY- 66

Mã mới	Mã cũ	Độ dày	Trọng lượng	Mã mới	Mã cũ	Độ dày	Trọng lượng	Mã mới	Mã cũ	Độ dày	Trọng lượng
DY660001180M	THC-6601	1.8 mm	1.881 kg/m	DY660002180M	THC-6603	1.8 mm	2.074 kg/m	DY660003180M	THC-6604	1.8 mm	1.202 kg/m
Mã mới	Mã cũ	Độ dày	Trọng lượng	Mã mới	Mã cũ	Độ dày	Trọng lượng	Mã mới	Mã cũ	Độ dày	Trọng lượng
DY660009120M	THC-6605	1.2 mm	0.451 kg/m	DY660011180M	THC-6602	1.8 mm	1.927 kg/m	DY660019120M	THC-6607	1.2 mm	0.23 kg/m
Mã mới	Mã cũ	Độ dày	Trọng lượng	Mã mới	Mã cũ	Độ dày	Trọng lượng	Mã mới	Mã cũ	Độ dày	Trọng lượng
DY660021120M	THC-6606	1.2 mm	0.413 kg/m								
Mã mới	Mã cũ	Độ dày	Trọng lượng	Mã mới	Mã cũ	Độ dày	Trọng lượng	Mã mới	Mã cũ	Độ dày	Trọng lượng
Mã mới	Mã cũ	Độ dày	Trọng lượng	Mã mới	Mã cũ	Độ dày	Trọng lượng	Mã mới	Mã cũ	Độ dày	Trọng lượng

HỆ CỬA LỬA DY-318

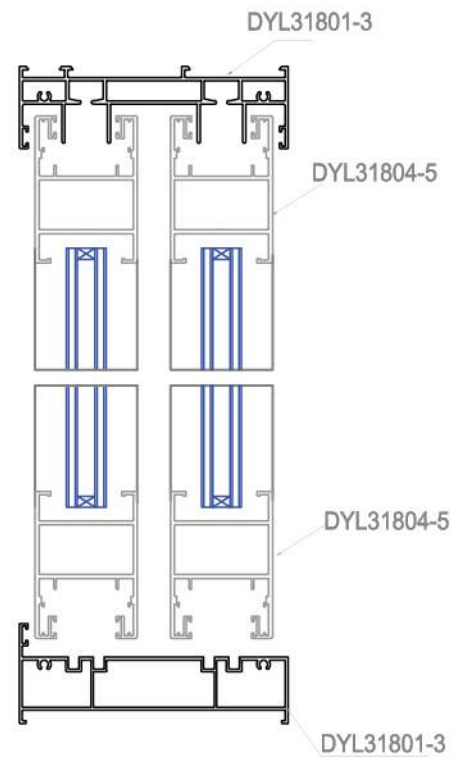
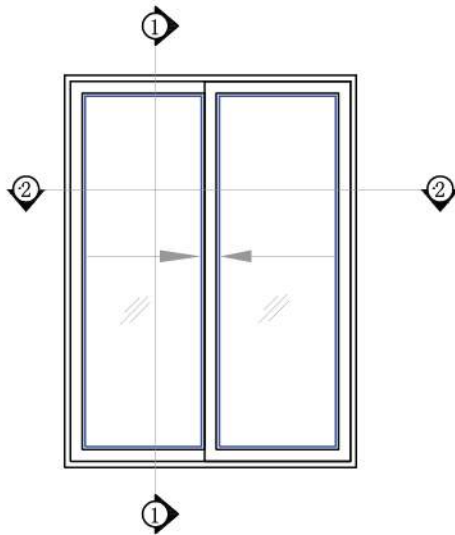

MẶT CẮT 1-1

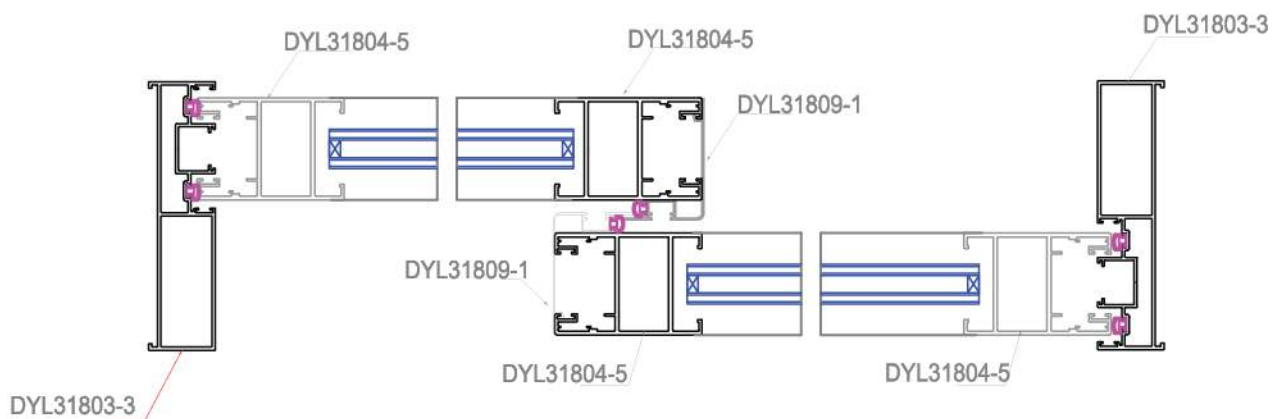

MẶT CẮT 2-2

LIST MẶT CẮT HỆ CỬA SỔ LỬA DY-318

Mã mới	Mã cũ	Độ dày	Trọng lượng	Mã mới	Mã cũ	Độ dày	Trọng lượng	Mã mới	Mã cũ	Độ dày	Trọng lượng
DYL31802-2	THC-3185	1.1 - 1.5	1.447 kg/m	DYL31803-3	THC-3184	1.5 mm	1.492 kg/m	DYL31804-5	THC-3182	1.8 mm	1.305 kg/m
Mã mới	Mã cũ	Độ dày	Trọng lượng	Mã mới	Mã cũ	Độ dày	Trọng lượng	Mã mới	Mã cũ	Độ dày	Trọng lượng
DYL31805-1	THC-3183	1.0 mm	0.229 kg/m	DYL31808-2	THC-3189	1.2 mm	0.089 kg/m	DYL31828-2	THC-31812	1.2 mm	0.456 kg/m
Mã mới	Mã cũ	Độ dày	Trọng lượng	Mã mới	Mã cũ	Độ dày	Trọng lượng	Mã mới	Mã cũ	Độ dày	Trọng lượng
DYL31809-1	THC-3181	0.85 mm	0.282 kg/m	DYL31811-2	THC-3188	1.2 mm	1.243 kg/m	DYL31814-5	THC-3182A	1.8 mm	1.398 kg/m
Mã mới	Mã cũ	Độ dày	Trọng lượng	Mã mới	Mã cũ	Độ dày	Trọng lượng	Mã mới	Mã cũ	Độ dày	Trọng lượng
DYL31815-1	THC-31811	1.0 mm	0.377 kg/m	DYL31818-2	THC-31810	1.2 mm	0.788 kg/m	DYL31822-1	THC-3187	1.05 mm	0.161 kg/m
Mã mới	Mã cũ	Độ dày	Trọng lượng	Mã mới	Mã cũ	Độ dày	Trọng lượng	Mã mới	Mã cũ	Độ dày	Trọng lượng

HỆ CỬA ĐI DY76

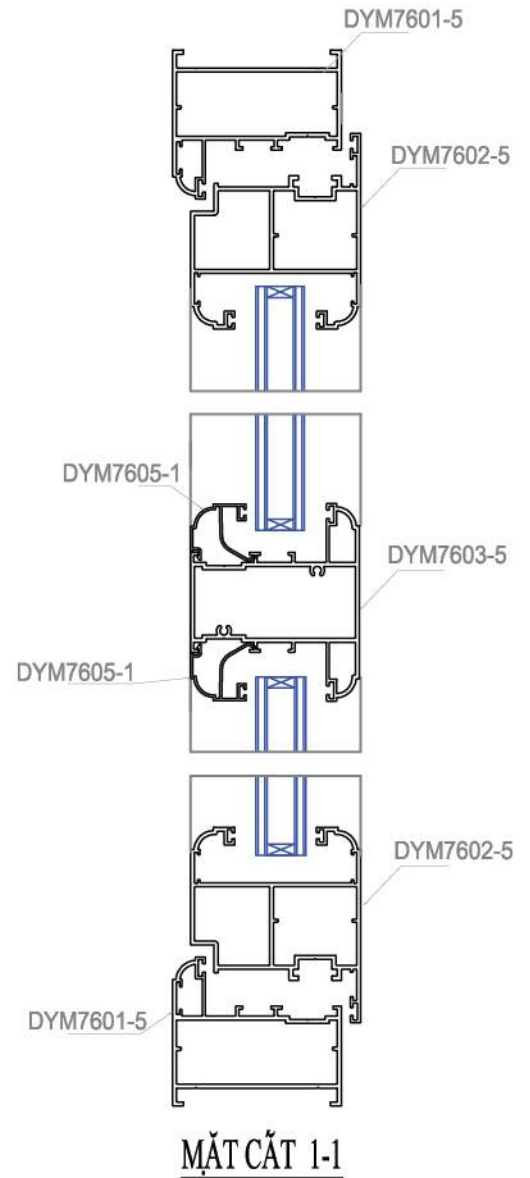
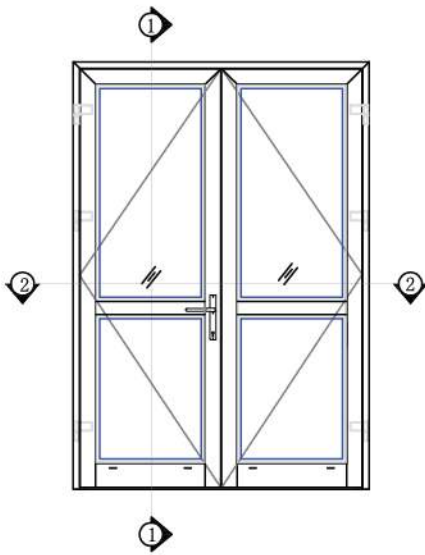

MẶT CẮT 1-1

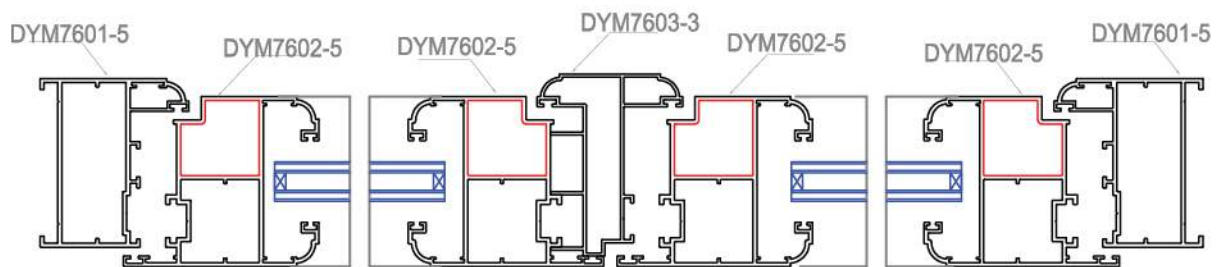

MẶT CẮT 2-2

LIST MẶT CẮT HỆ CỬA ĐI DY76

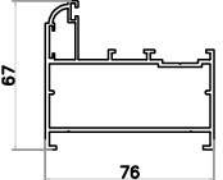
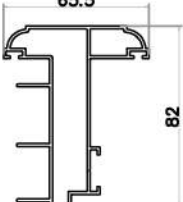
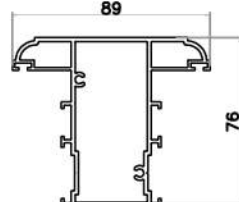
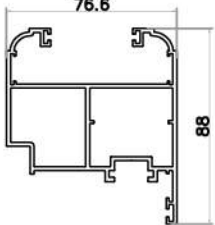
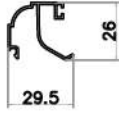
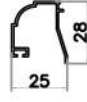
											
Mã mới	Mã cũ	Độ dày	Trọng lượng	Mã mới	Mã cũ	Độ dày	Trọng lượng	Mã mới	Mã cũ	Độ dày	Trọng lượng
DYM7601-5	THC-7601	1.8 mm	1.540 kg/m	DYM7603-3	THC-7602	1.4 mm	1.365 kg/m	DYM7603-5	THC-7603	1.8 mm	1.865 kg/m
											
Mã mới	Mã cũ	Độ dày	Trọng lượng	Mã mới	Mã cũ	Độ dày	Trọng lượng	Mã mới	Mã cũ	Độ dày	Trọng lượng
DYM7602-5	THC-7604	1.8 mm	2.032 kg/m	DYM7605-1	THC-7605	1.0 mm	0.266 kg/m	DYM7604-1	THC-7606	1.0 mm	0.229 kg/m
Mã mới	Mã cũ	Độ dày	Trọng lượng	Mã mới	Mã cũ	Độ dày	Trọng lượng	Mã mới	Mã cũ	Độ dày	Trọng lượng
Mã mới	Mã cũ	Độ dày	Trọng lượng	Mã mới	Mã cũ	Độ dày	Trọng lượng	Mã mới	Mã cũ	Độ dày	Trọng lượng
Mã mới	Mã cũ	Độ dày	Trọng lượng	Mã mới	Mã cũ	Độ dày	Trọng lượng	Mã mới	Mã cũ	Độ dày	Trọng lượng

HỆ CỬA LỬA 3 CẢNH DY - 95

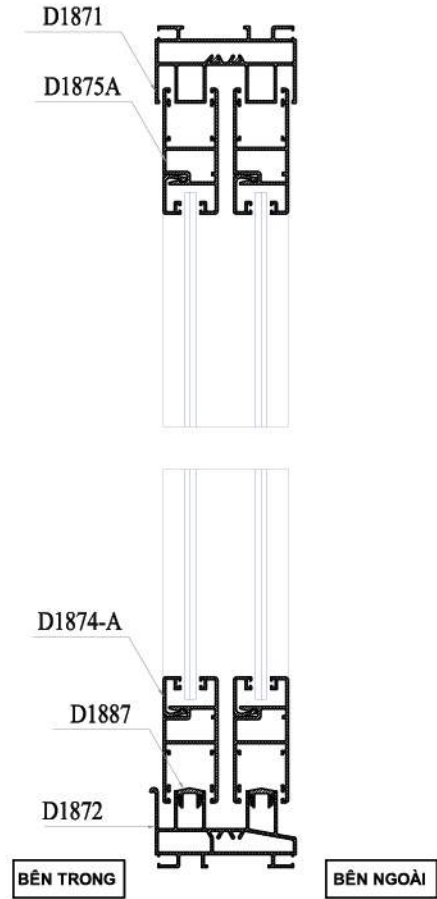
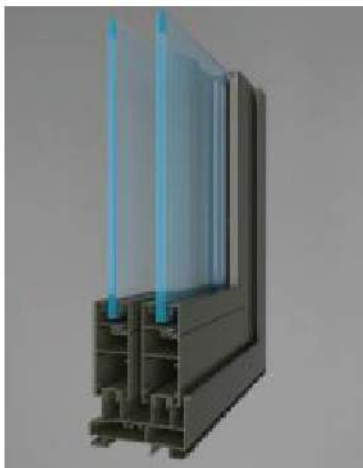
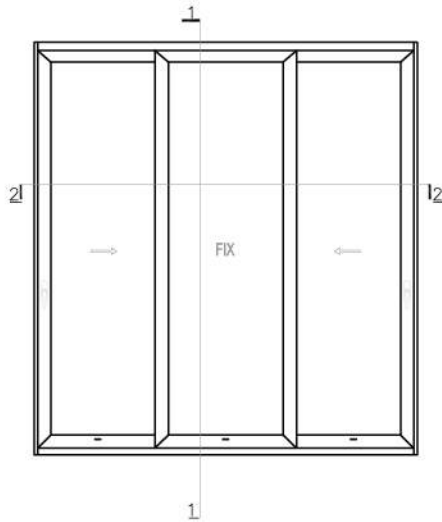

MẶT CẮT 1-1

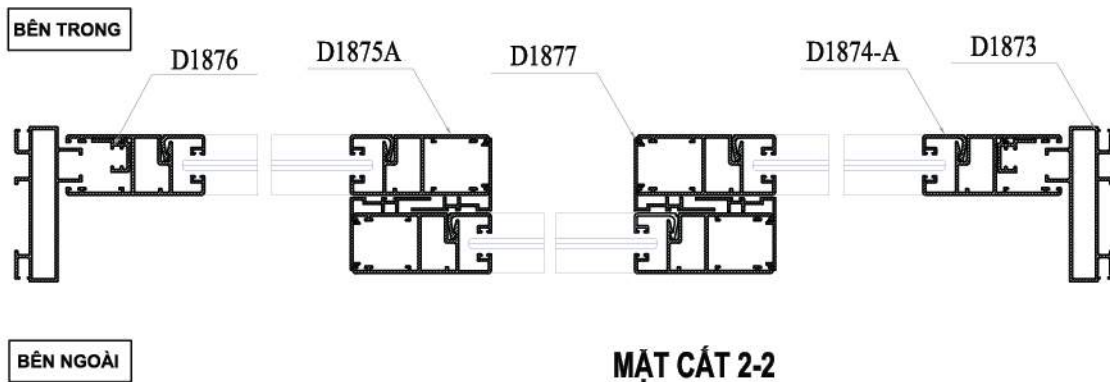

MẶT CẮT 2-2

LIST MẶT CẮT HỆ DY - 95

Ray trên				Cánh lùa				Sập			
Mã mới	Mã cũ	Độ dày	Trọng lượng	Mã mới	Mã cũ	Độ dày	Trọng lượng	Mã mới	Mã cũ	Độ dày	Trọng lượng
DY950017000	D1871	1.7 mm	2.228 kg/m	DY950014000	D1875A	1.8 mm	1.316 kg/m	DY950011000	D1874-A	1.8 mm	0.295 kg/m
Ray dưới				Đứng khung bao				Thanh truyền động			
Mã mới	Mã cũ	Độ dày	Trọng lượng	Mã mới	Mã cũ	Độ dày	Trọng lượng	Mã mới	Mã cũ	Độ dày	Trọng lượng
DY950009000	D1887		0.21 kg/m	DY950016000	D1872	1.7 mm	2.15 kg/m	DY950010000	D1876	1.7 mm	0.304 kg/m
Đứng khung bao				Đứng khung bao				Đứng khung bao			
Mã mới	Mã cũ	Độ dày	Trọng lượng	Mã mới	Mã cũ	Độ dày	Trọng lượng	Mã mới	Mã cũ	Độ dày	Trọng lượng
DY950013000	D1877	1.5 mm	0.493 kg/m	DY950015170	D1873	1.7 mm	1.432 kg/m	DY950008000	D1870		0.375 kg/m
Thanh truyền động				Thanh truyền động				Thanh truyền động			
Mã mới	Mã cũ	Độ dày	Trọng lượng	Mã mới	Mã cũ	Độ dày	Trọng lượng	Mã mới	Mã cũ	Độ dày	Trọng lượng
DY950012000	D1880		0.115 kg/m	DY950002100	DADLC-01	1.0 mm	0.217 kg/m				
Mã mới	Mã cũ	Độ dày	Trọng lượng	Mã mới	Mã cũ	Độ dày	Trọng lượng	Mã mới	Mã cũ	Độ dày	Trọng lượng

MẶT DỰNG XƯƠNG NỔI HỆ DY - 1200

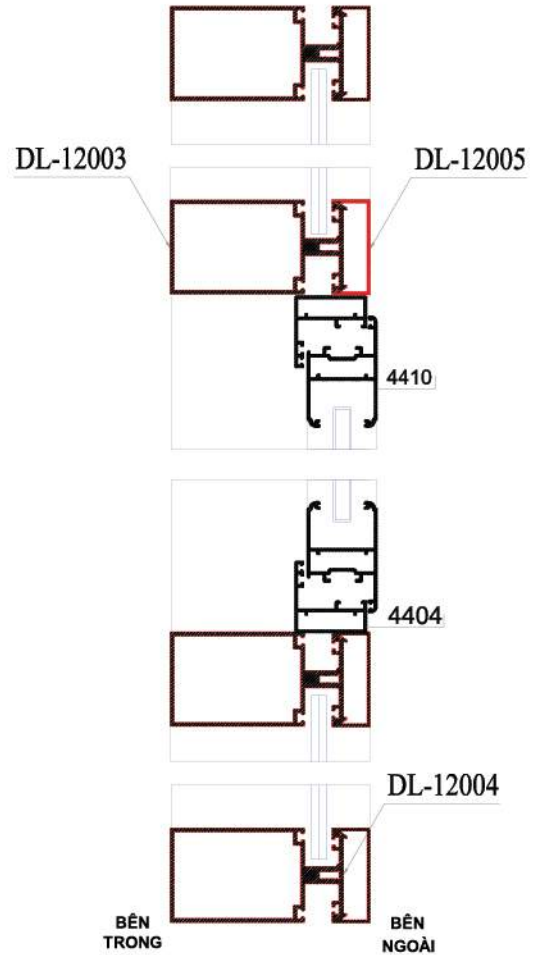
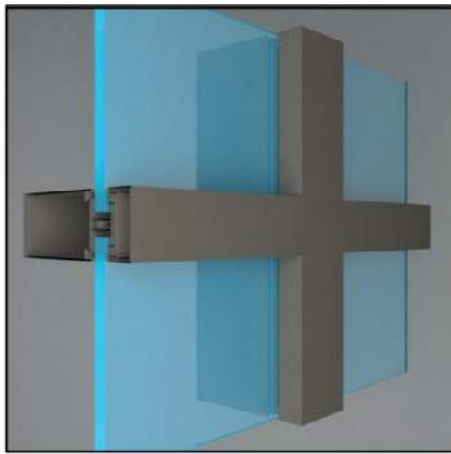
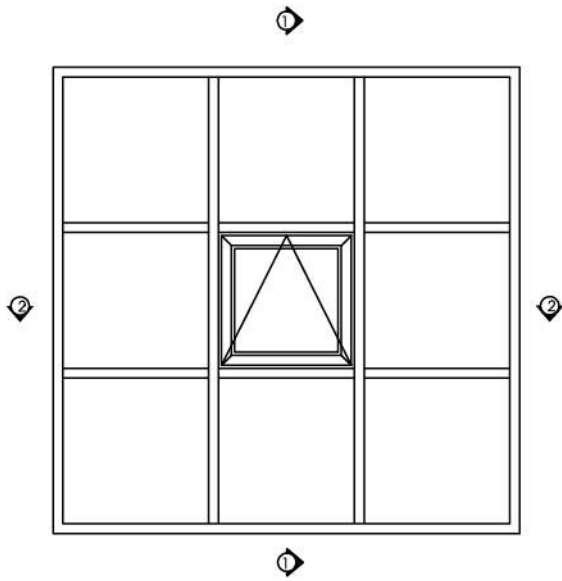

MẶT CẮT 1-1

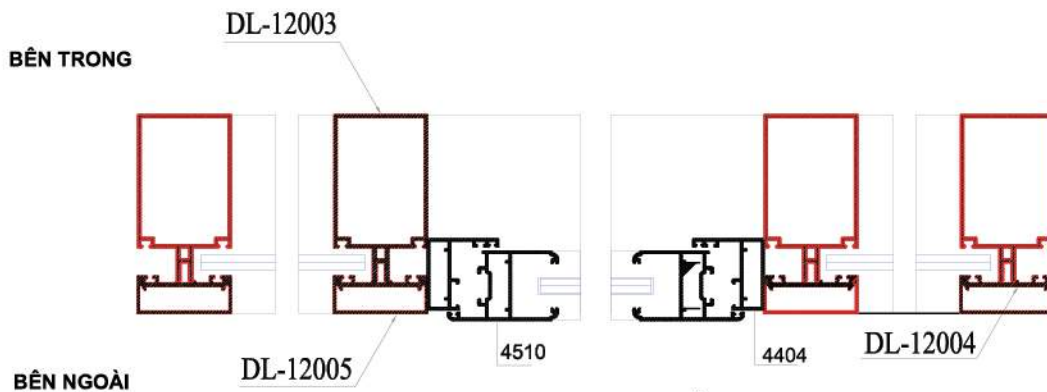

MẶT CẮT 2-2

LIST MẶT CẮT HỆ DY - 1200

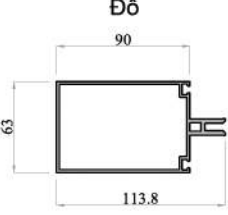
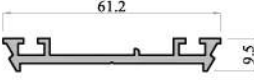
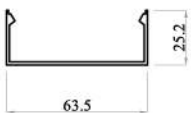
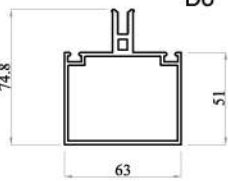
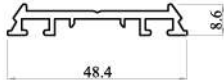
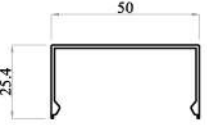
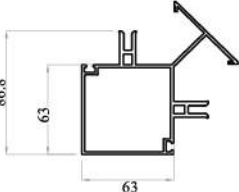
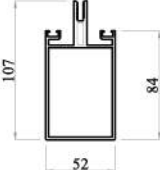
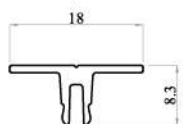
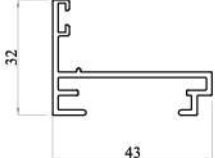
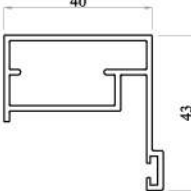
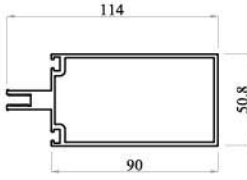
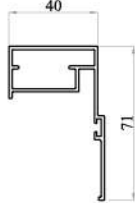
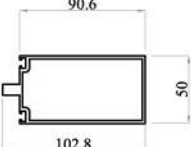
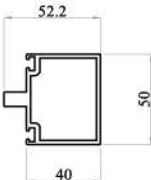
 <p>Đố</p>				 <p>Xương</p>				 <p>Óp</p>			
Mã mới	Mã cũ	Độ dày	Trọng lượng	Mã mới	Mã cũ	Độ dày	Trọng lượng	Mã mới	Mã cũ	Độ dày	Trọng lượng
DY120061200	DL-12003	2.0 mm	2.054 kg/m	DY120055000	DL-12004	2.4 mm	0.54 kg/m	DY120055140	DL-12005	1.4 mm	0.455 kg/m
 <p>Đố</p>				 <p>Xương</p>				 <p>Óp</p>			
Mã mới	Mã cũ	Độ dày	Trọng lượng	Mã mới	Mã cũ	Độ dày	Trọng lượng	Mã mới	Mã cũ	Độ dày	Trọng lượng
DY120063200	DL-12001	2.0 mm	1.608 kg/m	DY110054000	DL-11004	2.1 mm	0.403 kg/m	DY110055110	DL-11005	1.1 mm	0.318 kg/m
 <p>Góc</p>				 <p>Đố</p>				 <p>Óp</p>			
Mã mới	Mã cũ	Độ dày	Trọng lượng	Mã mới	Mã cũ	Độ dày	Trọng lượng	Mã mới	Mã cũ	Độ dày	Trọng lượng
DY120071200	DL-12007	2.0 mm	2.648 kg/m	DY110101210	DL-11014	2.1 mm	2.145 kg/m	DYG12580000	VS-MD05	1.0 mm	0.106 kg/m
 <p>Khung cửa sổ</p>				 <p>Cánh cửa sổ</p>				 <p>Đố</p>			
Mã mới	Mã cũ	Độ dày	Trọng lượng	Mã mới	Mã cũ	Độ dày	Trọng lượng	Mã mới	Mã cũ	Độ dày	Trọng lượng
DYG16525150	DA.MD02	1.5 mm	0.46 kg/m	DYG16526150	DA.MD03	1.5 mm	0.676 kg/m	DYG17640200M1	MH-DQ-SC-001	2.0 mm	2.070 kg/m
				 <p>Đố</p>							
Mã mới	Mã cũ	Độ dày	Trọng lượng	Mã mới	Mã cũ	Độ dày	Trọng lượng	Mã mới	Mã cũ	Độ dày	Trọng lượng
DYG16524150	DA.MD01	1.5 mm	0.798 kg/m	DY120051220	DY-TV1201	2.2 mm	1.983 kg/m	DY110005220	DY-TV1201A	2.2 mm	1.380 kg/m

MẶT DỰNG XƯƠNG CHÌM HỆ DY - 1100

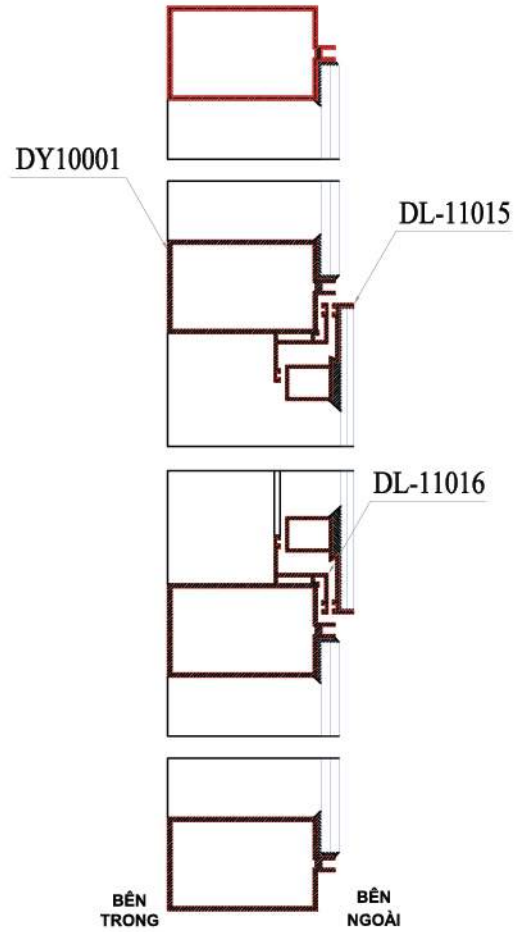
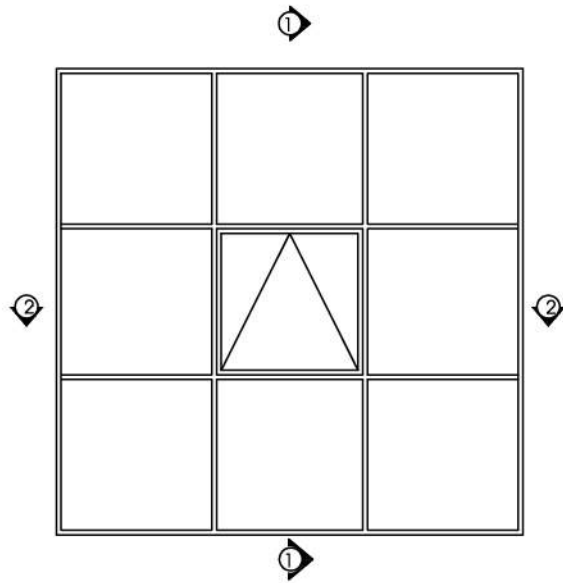

MẶT CẮT 1-1

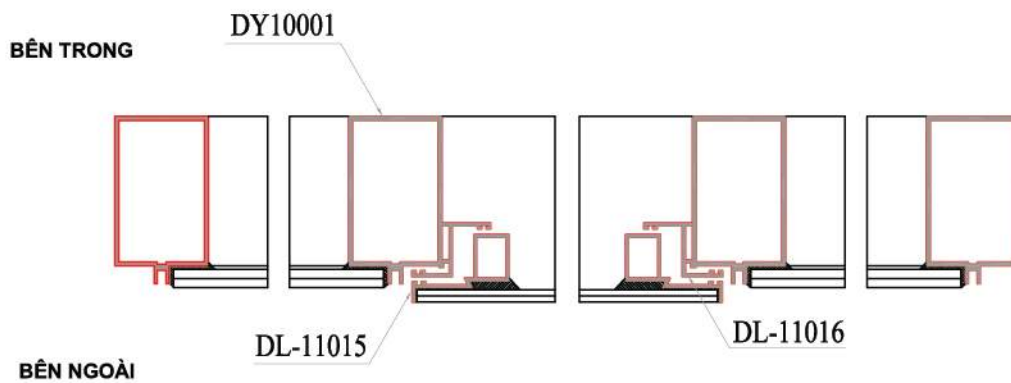

MẶT CẮT 2-2

LIST MẶT CẮT HỆ DY - 1100

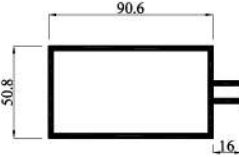
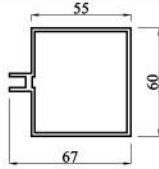
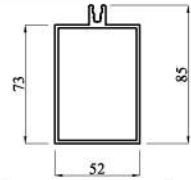
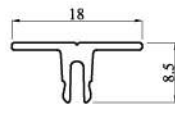
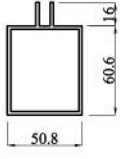
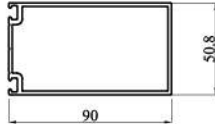
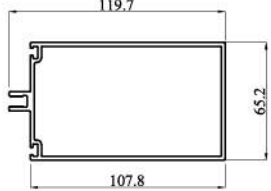
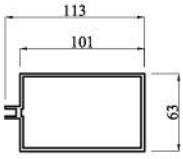
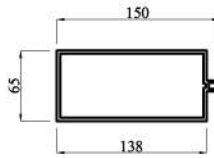
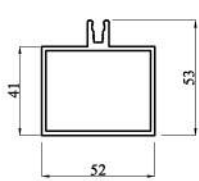
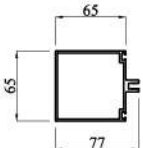
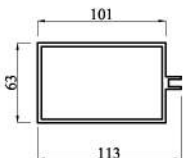
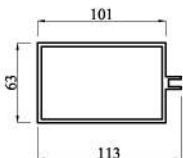
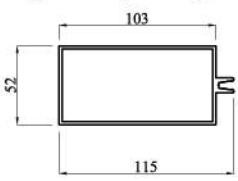
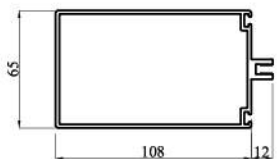
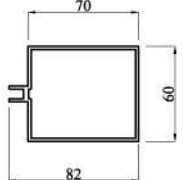
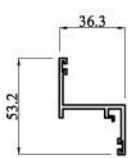
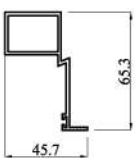
<p>Đố</p> 				<p>Đố</p> 				<p>Đố</p> 						
Mã mới	Mã cũ	Độ dày	Trọng lượng	Mã mới	Mã cũ	Độ dày	Trọng lượng	Mã mới	Mã cũ	Độ dày	Trọng lượng			
DY110073200	DL-12014	2.0 mm	1.359 kg/m	DYG12579200	VS-MD01	2.0 mm	1.515 kg/m							
Mã mới	Mã cũ	Độ dày	Trọng lượng	<p>Ốp</p> 										
DY110001230	DY10001	2.3 mm	1.904 kg/m	Mã mới	Mã cũ	Độ dày	Trọng lượng							
<p>Đố</p> 				<p>Đố</p> 				<p>Mã mới</p>				Mã cũ	Độ dày	Trọng lượng
Mã mới	Mã cũ	Độ dày	Trọng lượng	DYG17627200M1	MH-THC-2030	2.0 mm	1.597 kg/m							
<p>Mã mới</p>				Mã cũ	Độ dày	Trọng lượng	<p>Đố</p> 							
DY110011230	DY10011	2.3 mm	1.53 kg/m	Mã mới	Mã cũ	Độ dày	Trọng lượng							
<p>Đố</p> 				<p>Đố</p> 				<p>Mã mới</p>				Mã cũ	Độ dày	Trọng lượng
Mã mới	Mã cũ	Độ dày	Trọng lượng	DYG13493300		3.0 mm	3.38 kg/m	Mã mới	Mã cũ	Độ dày	Trọng lượng			
DY110051260	DL-12011	2.6 mm	2.425 kg/m	<p>Đố</p> 				<p>Đố</p> 						
<p>Đố</p> 				<p>Mã mới</p>				Mã cũ	Độ dày	Trọng lượng	Mã mới	Mã cũ	Độ dày	Trọng lượng
Mã mới	Mã cũ	Độ dày	Trọng lượng	DYG12577200	VS-MD02	2.0 mm	1.157 kg/m	DYG18484200	VS-MD6577	2.0 mm	1.652 kg/m			
<p>Đố</p> 				<p>Đố</p> 				<p>Đố</p> 						
Mã mới	Mã cũ	Độ dày	Trọng lượng	Mã mới	Mã cũ	Độ dày	Trọng lượng	Mã mới	Mã cũ	Độ dày	Trọng lượng			
DY110051280	DY-TV1101	2.8 mm	2.58 kg/m	DYG12578200	VS-MD06	2.0 mm	1.843 kg/m	DYG18483200	VS-MD65120	2.0 mm	2.119 kg/m			
<p>Đố</p> 				<p>Khung</p> 				<p>Cánh</p> 						
Mã mới	Mã cũ	Độ dày	Trọng lượng	Mã mới	Mã cũ	Độ dày	Trọng lượng	Mã mới	Mã cũ	Độ dày	Trọng lượng			
DY110063200	DL-12013	2.0 mm	1.522 kg/m	DY110106200	DL-11016	2.0 mm	0.574 kg/m	DY110105180	DL-11015	1.8 mm	0.802 kg/m			

MẶT DỰNG HỆ DY - 130 ;140

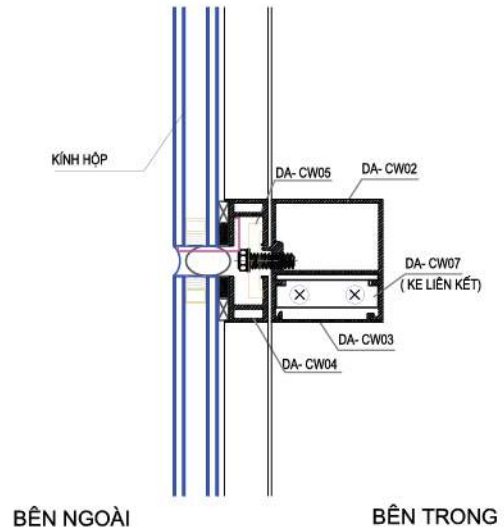
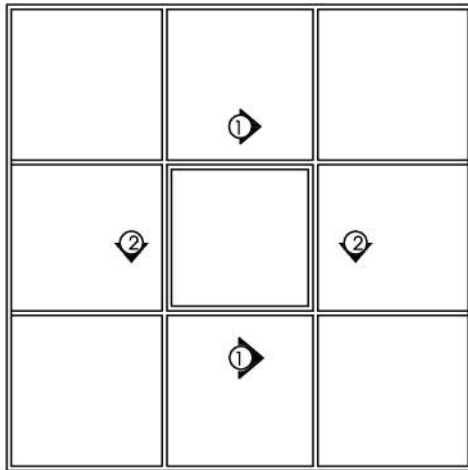

MẶT CẮT 1-1

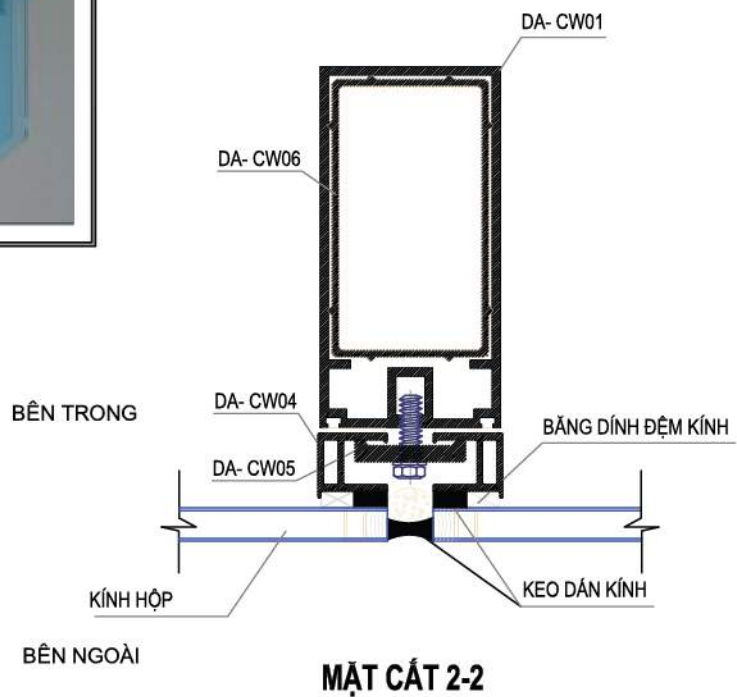
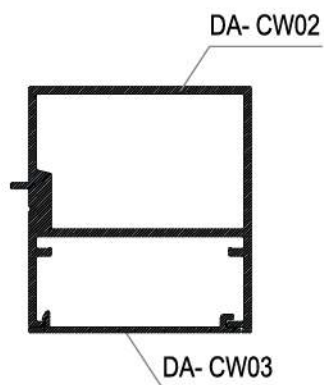

MẶT CẮT 2-2

LIST MẶT CẮT HỆ DY-130; 140

Mã mới	Mã cũ	Độ dày	Trọng lượng	Mã mới	Mã cũ	Độ dày	Trọng lượng	Mã mới	Mã cũ	Độ dày	Trọng lượng
DYG13780300	DA-CW01	3.0 mm	3.548 kg/m	DYG13785250	DA-CW06	2.5 mm	2.086 kg/m	DYG19559150	H078	1.5 mm	0.593 kg/m
Mã mới	Mã cũ	Độ dày	Trọng lượng	Mã mới	Mã cũ	Độ dày	Trọng lượng	Mã mới	Mã cũ	Độ dày	Trọng lượng
DYG13781200	DA-CW02	2.0 mm	1.574 kg/m	DYT10709300	DA-CW07	3.0 mm	0.381 kg/m	DYG19560150	H079	1.5 mm	0.826 kg/m
Mã mới	Mã cũ	Độ dày	Trọng lượng	Mã mới	Mã cũ	Độ dày	Trọng lượng	Mã mới	Mã cũ	Độ dày	Trọng lượng
DYG13782000	DA-CW03	1.5 mm	0.265 kg/m	DYG19561300		3.0 mm	3.724 kg/m	DYG19562250		2.5 mm	2.229 kg/m
Mã mới	Mã cũ	Độ dày	Trọng lượng	Mã mới	Mã cũ	Độ dày	Trọng lượng	Mã mới	Mã cũ	Độ dày	Trọng lượng
DYG13783000	DA-CW05	6.0 mm	0.692 kg/m								
Mã mới	Mã cũ	Độ dày	Trọng lượng	Mã mới	Mã cũ	Độ dày	Trọng lượng	Mã mới	Mã cũ	Độ dày	Trọng lượng
DYG13784000	DA-CW04	2.5 mm	0.529 kg/m								

HỆ CỬA ĐI MỞ QUAY DY - 8800

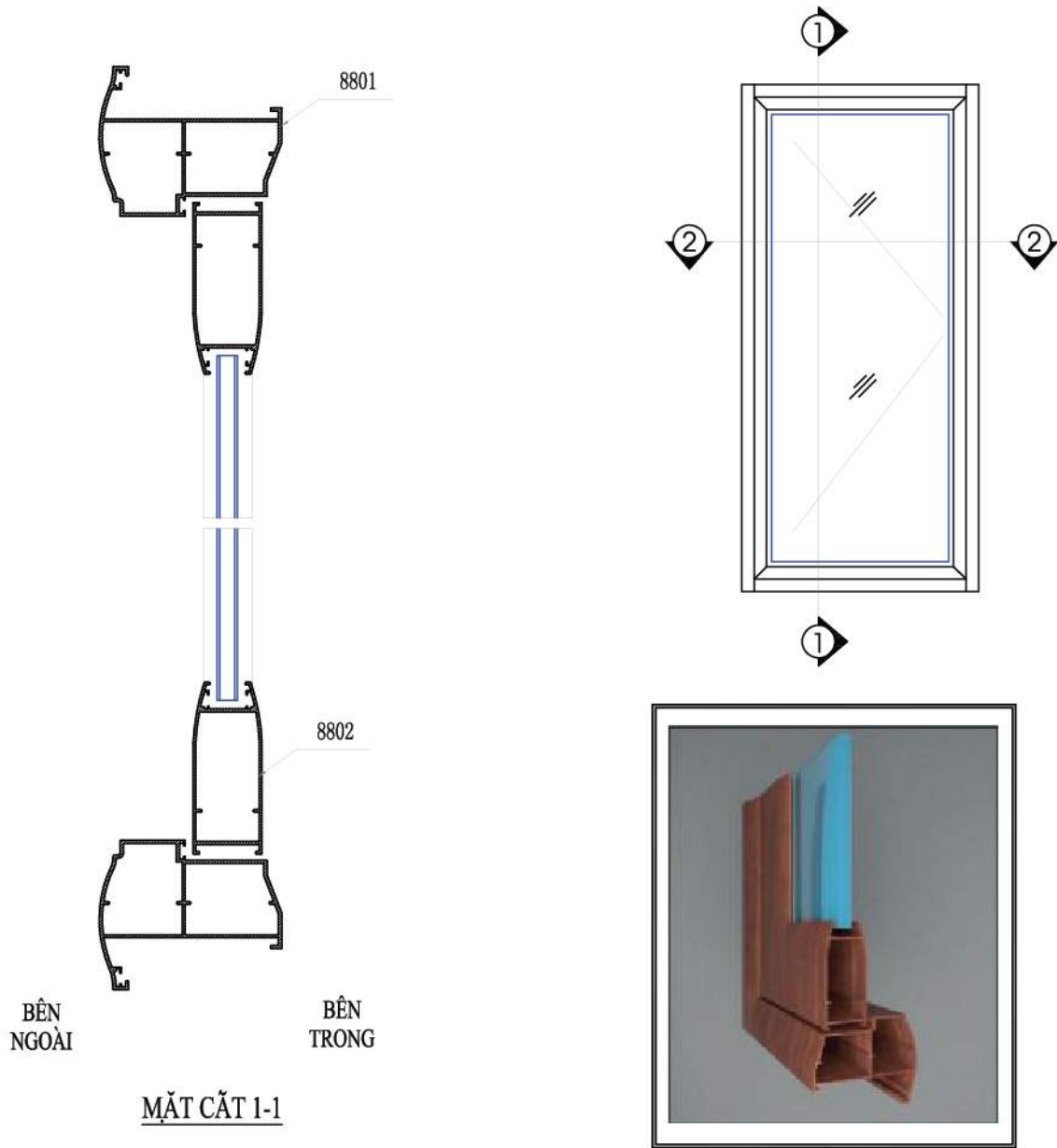

BÊN
NGOÀI

BÊN
TRONG

MẶT CẮT 1-1

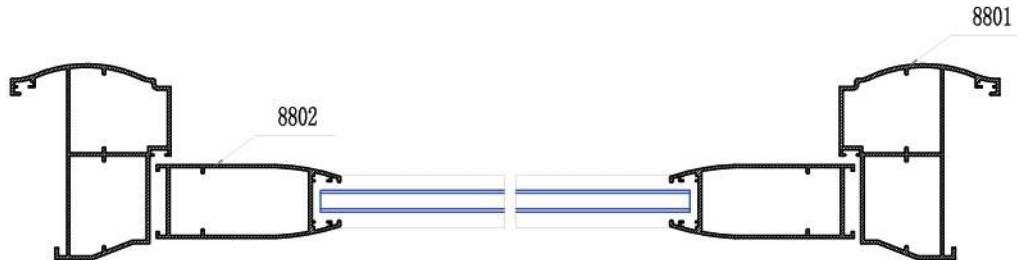

BÊN
NGOÀI

BÊN
TRONG



MẶT CẮT 2-2

LIST MẶT CẮT HỆ DY - 8800

											
Mã mới	Mã cũ	Độ dày	Trọng lượng	Mã mới	Mã cũ	Độ dày	Trọng lượng	Mã mới	Mã cũ	Độ dày	Trọng lượng
DYG15267160	8801	1.6 mm	1.447 kg/m	DYG15266140	8802	1.4 mm	1.049 kg/m				
Mã mới	Mã cũ	Độ dày	Trọng lượng	Mã mới	Mã cũ	Độ dày	Trọng lượng	Mã mới	Mã cũ	Độ dày	Trọng lượng
Mã mới	Mã cũ	Độ dày	Trọng lượng	Mã mới	Mã cũ	Độ dày	Trọng lượng	Mã mới	Mã cũ	Độ dày	Trọng lượng
Mã mới	Mã cũ	Độ dày	Trọng lượng	Mã mới	Mã cũ	Độ dày	Trọng lượng	Mã mới	Mã cũ	Độ dày	Trọng lượng
Mã mới	Mã cũ	Độ dày	Trọng lượng	Mã mới	Mã cũ	Độ dày	Trọng lượng	Mã mới	Mã cũ	Độ dày	Trọng lượng

HỆ CỬA SỔ LỬA DY- 44

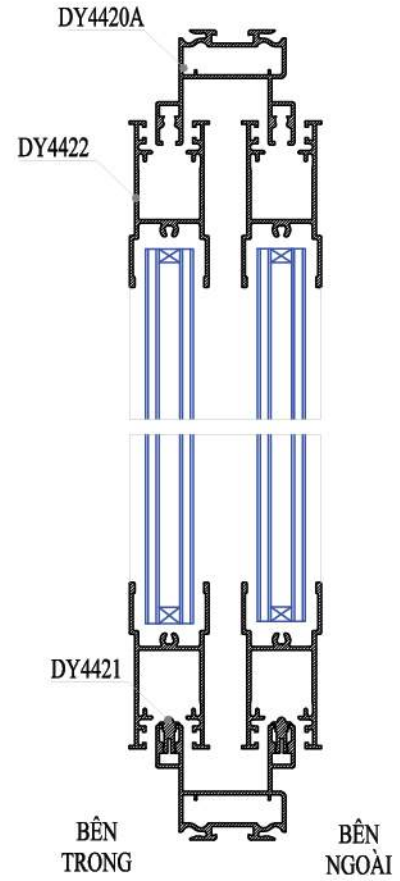
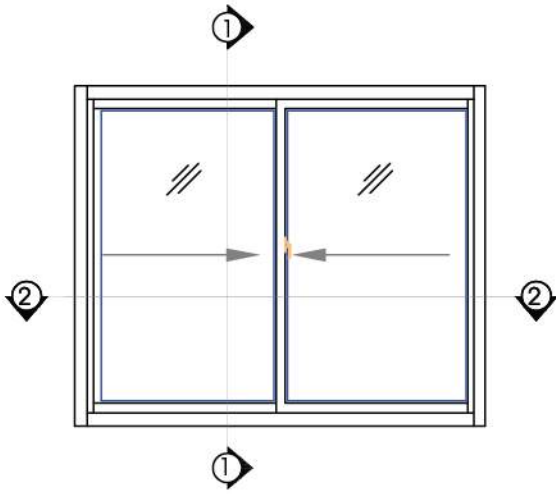

MẶT CẮT 1-1

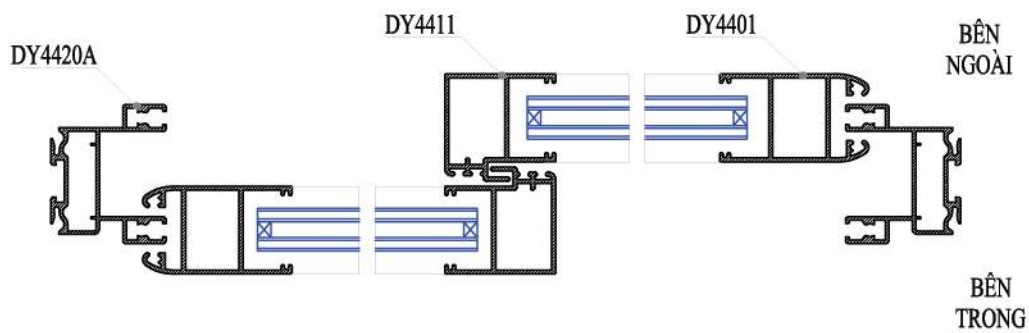

MẶT CẮT 2-2

VÁCH KÍNH HỆ DY - 44

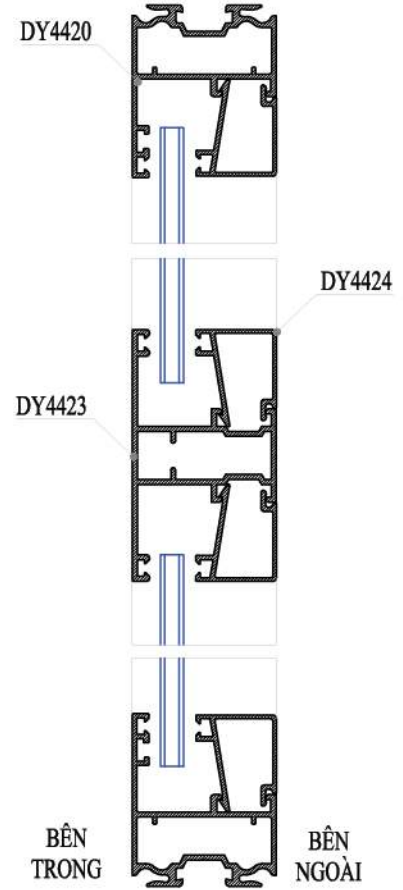
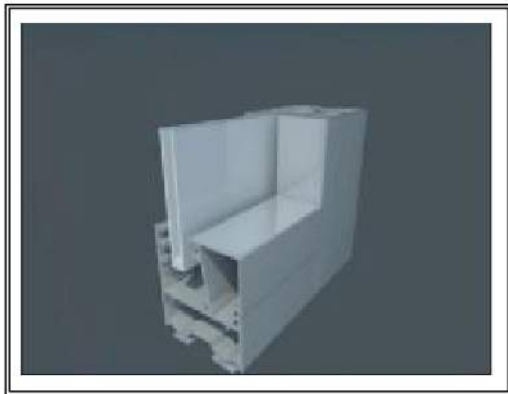
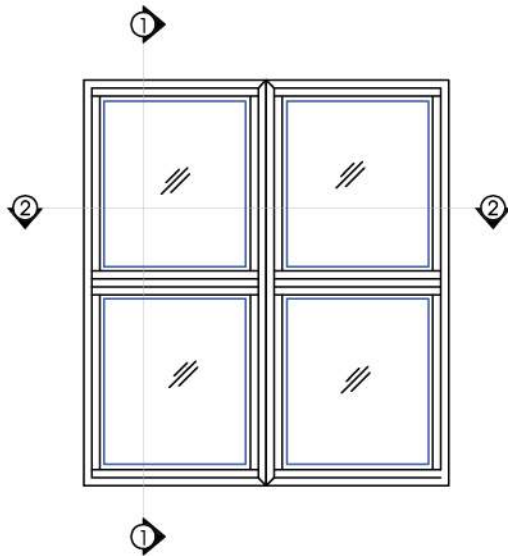

MẶT CẮT 1-1

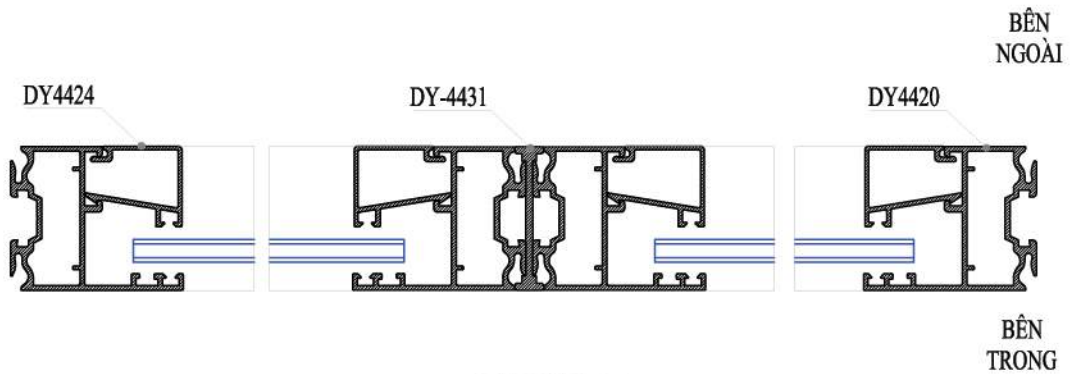

MẶT CẮT 2-2

HỆ CỬA SỔ BẠT DY - 44

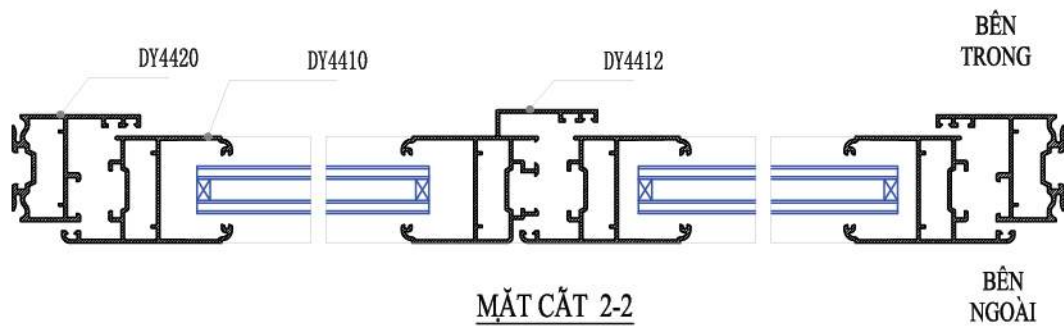
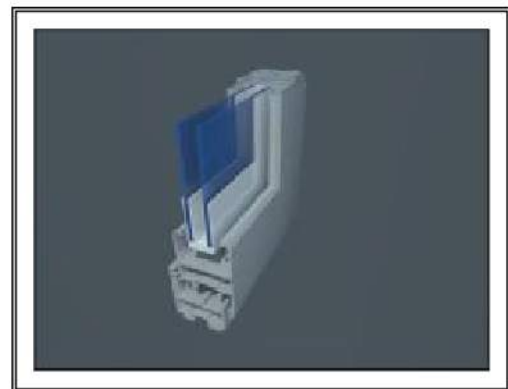
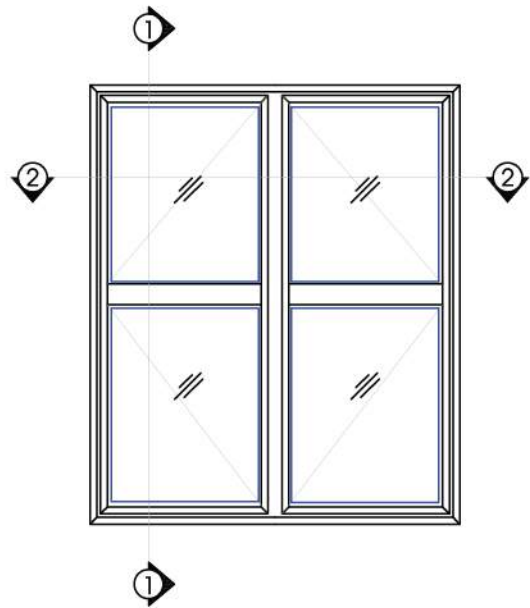
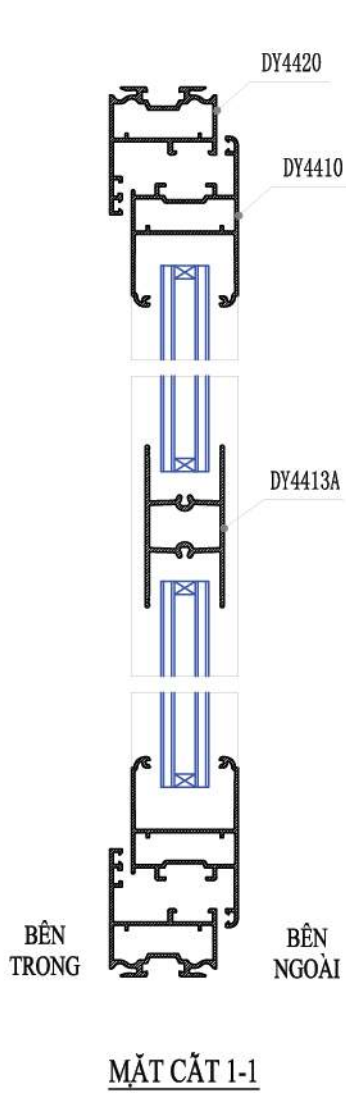

HỆ CỬA ĐI MỞ QUAY DY - 45

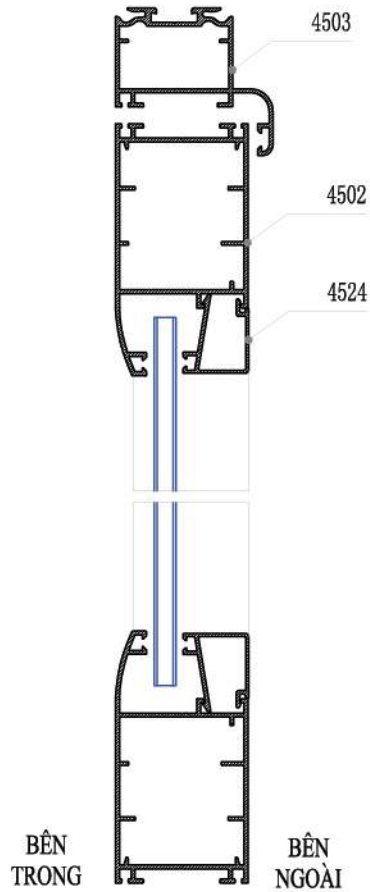

MẶT CẮT 1-1

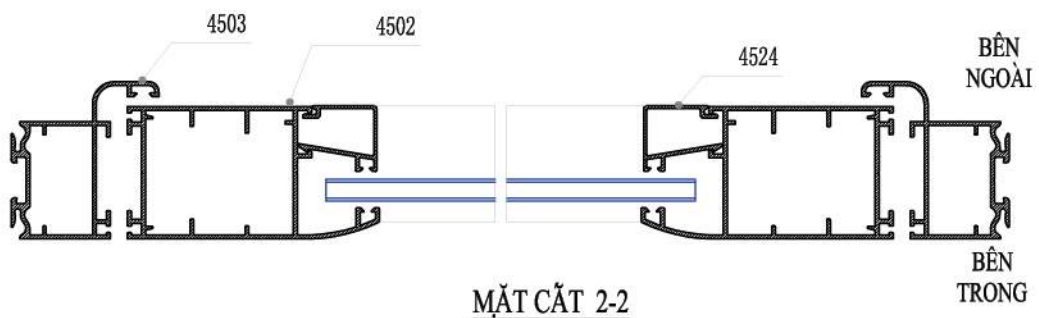
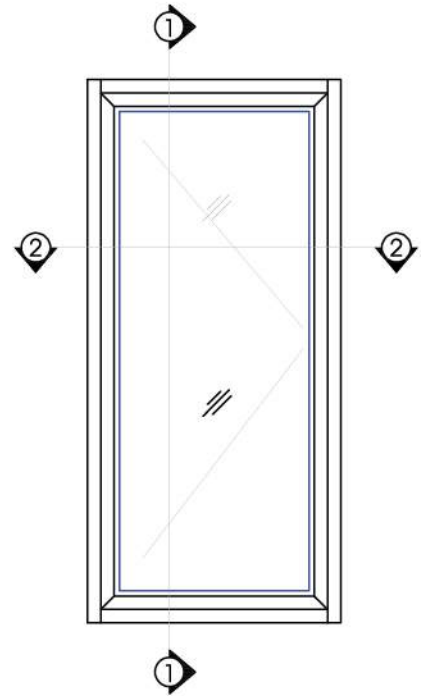



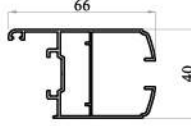
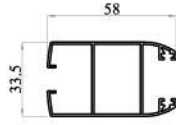
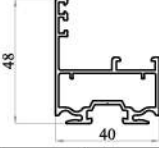
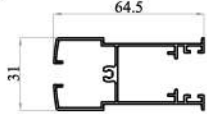
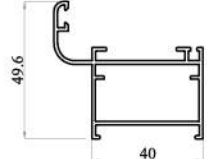
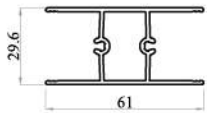
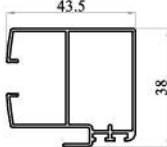
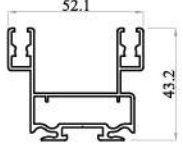
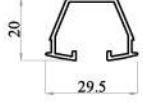
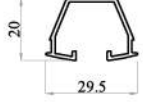
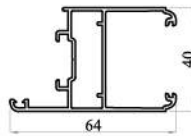
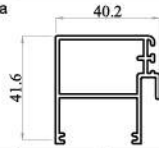
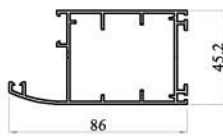
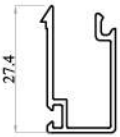
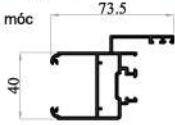
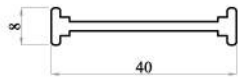
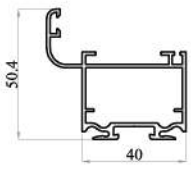
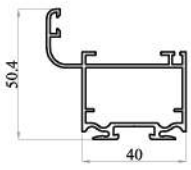

MẶT CẮT 2-2

LIST MẶT CẮT HỆ DY- 44, 45

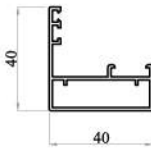
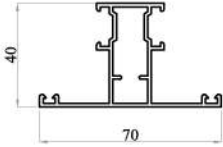
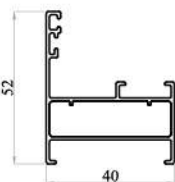
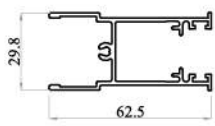
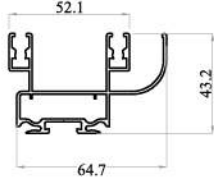
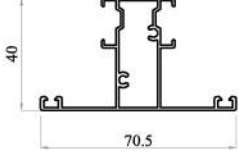
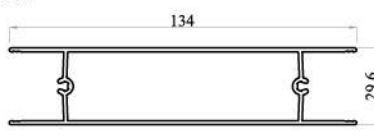
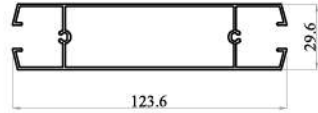
<p>Cánh 44 (hèm nhỏ)</p> 				<p>Đứng trơn lùa (hèm nhỏ)</p> 				<p>Khung bao 44</p> 						
Mã mới	Mã cũ	Độ dày	Trọng lượng	Mã mới	Mã cũ	Độ dày	Trọng lượng	Mã mới	Mã cũ	Độ dày	Trọng lượng			
DY440009140	DY4410A	1.4 mm	0.925 kg/m	DYG15152120	4501A-2	1.2 mm	0.754 kg/m	DY440015140	4420-1	1.4 mm	0.77 kg/m			
DY450009120	DY4510A-1	1.2 mm	0.805 kg/m	DYG15152110	4501A-1	1.1 mm	0.684 kg/m	DY440020130	DY4420	1.3 mm	0.724 kg/m			
DY450009110	DY4501A REV1	1.1 mm	0.734 kg/m	DYG15152100	4501A	1.0 mm	0.633 kg/m	DY450020110	4520	1.1 mm	0.64 kg/m			
DY450009100	4510E	1.0 mm	0.662 kg/m	<p>Ngang cánh lùa (hèm nhỏ)</p> 				<p>Khung bao 45 (chân vuông)</p> 						
Mã mới	Mã cũ	Độ dày	Trọng lượng					Mã mới	Mã cũ	Độ dày	Trọng lượng	Mã mới	Mã cũ	Độ dày
DY440008130	DY4408	1.3 mm	0.263 kg/m	DY450008115	4508	1.15 mm	0.247 kg/m	DY450006130	4503A	1.3 mm	0.722 kg/m			
DY450008115	4508	1.15 mm	0.247 kg/m	<p>Đổ nhỏ</p> 				DY450006120	4503A-1	1.2 mm	0.687 kg/m			
DY450008115	4508	1.15 mm	0.247 kg/m					DY450032110	DA4503A	1.1 mm	0.608 kg/m			
Mã mới	Mã cũ	Độ dày	Trọng lượng	<p>Đứng móc lùa (hèm nhỏ)</p> 				<p>Ray cửa lùa</p> 						
DYG15154120	4522A-2	1.2 mm	0.77 kg/m									Mã mới	Mã cũ	Độ dày
DYG15154110	4522A-1	1.1 mm	0.701 kg/m	DY440023150	DY4413A	1.5 mm	0.769 kg/m	DY440030130	DY4420A	1.3 mm	0.919 kg/m			
DYG15154100	4522A	1.0 mm	0.661 kg/m	DY450023125	4513A	1.25 mm	0.64 kg/m	DY450030120	4520A-1	1.2 mm	0.893 kg/m			
<p>Hèm</p> 				<p>Mã mới</p>				Mã cũ	Độ dày	Trọng lượng	DY450030100	4520A	1.0 mm	0.797 kg/m
								DY440023150	DY4413A	1.5 mm	0.769 kg/m	DY440030130	DY4420A	1.3 mm
Mã mới	Mã cũ	Độ dày	Trọng lượng	DY450023125	4513A	1.25 mm	0.64 kg/m	DY450030120	4520A-1	1.2 mm	0.893 kg/m			
DYG15155120	4511A-2	1.2 mm	0.657 kg/m	<p>Hèm</p> 				DY450030100	4520A	1.0 mm	0.797 kg/m			
DYG15155110	4511A-1	1.1 mm	0.603 kg/m					Mã mới	Mã cũ	Độ dày	Trọng lượng	Mã mới	Mã cũ	Độ dày
DYG15155100	4511A	1.0 mm	0.554 kg/m	DY440025120	DY4425	1.2 mm	0.243 kg/m	DY440030130	DY4420A	1.3 mm	0.919 kg/m			
<p>Cánh 44</p> 				<p>Cánh móc lùa</p> 				<p>Cánh 45</p> 						
												DY440025120	DY4425	1.2 mm
Mã mới	Mã cũ	Độ dày	Trọng lượng	DY450015100	4525	1.0 mm	0.186 kg/m	DY450030120	4520A-1	1.2 mm	0.893 kg/m			
DY440010120	DY4410	1.2 mm	0.76 kg/m	<p>Sập</p> 				DY450030100	4520A	1.0 mm	0.797 kg/m			
DY450010100	4510	1.0 mm	0.644 kg/m					Mã mới	Mã cũ	Độ dày	Trọng lượng	Mã mới	Mã cũ	Độ dày
<p>Đứng cánh móc</p> 				<p>Nổi khung</p> 				<p>Khung bao 45</p> 						
												DY440011150	DY4411	1.5 mm
DY450011117	4511	1.17 mm	0.598 kg/m	DY440011150	DY4411	1.5 mm	0.729 kg/m	DY450007120	4502 REV1	1.2 mm	0.982 kg/m			
Mã mới	Mã cũ	Độ dày	Trọng lượng	DY450011117	4511	1.17 mm	0.598 kg/m	DY450005100	4502-A	1.0 mm	0.922 kg/m			
DY440012120	DY4412	1.2 mm	0.899 kg/m	<p>Mã mới</p>				Mã cũ	Độ dày	Trọng lượng	<p>Khung bao 45</p> 			
DY450012100	4512	1.0 mm	0.77 kg/m					DY440034100	DY-4434	1.0 mm				
<p>Mã mới</p>				Mã cũ	Độ dày	Trọng lượng	<p>Mã mới</p>				Mã cũ	Độ dày	Trọng lượng	
				DY440034100	DY-4434	1.0 mm					0.227 kg/m	DY440014140	4403-1	1.4 mm
Mã mới	Mã cũ	Độ dày	Trọng lượng	DY440034100	DY-4434	1.0 mm	0.227 kg/m	DY440014140	4403-1	1.4 mm	0.876 kg/m			
DY440044140	DY-4444	1.4 mm	0.332 kg/m	DY440031200	DY-4431	2.0 mm	0.301 kg/m	DY440003130	DY4403	1.3 mm	0.811 kg/m			
DY440044140	DY-4444	1.4 mm	0.332 kg/m	DY440031200	DY-4431	2.0 mm	0.301 kg/m	DY450003110	4503	1.1 mm	0.719 kg/m			

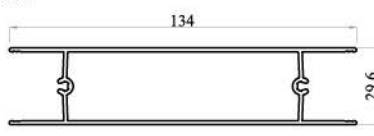
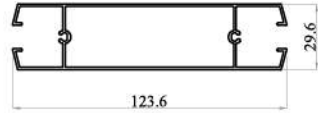
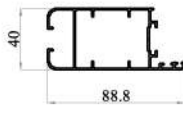
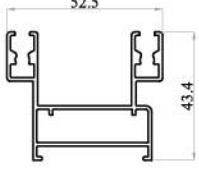
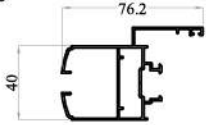
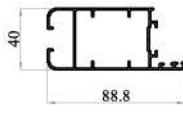
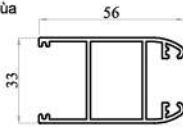
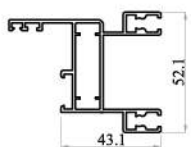
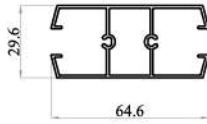
LIST MẶT CẮT HỆ DY - 44, 45

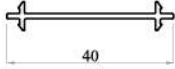
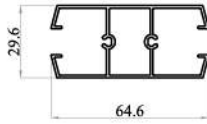
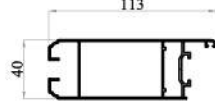
Khung MD 				T vách 							
Mã mới	Mã cũ	Độ dày	Trọng lượng	Mã mới	Mã cũ	Độ dày	Trọng lượng	Mã mới	Mã cũ	Độ dày	Trọng lượng
DY440004120	DY4404	1.2 mm	0.509 kg/m	DY440023140	DY4423	1.4 mm	0.797 kg/m	DYG15153120	4504A	1.2 mm	0.643 kg/m
DY450004100	4504	1.0 mm	0.433 kg/m	DY450023120	4523-1	1.2 mm	0.701 kg/m	DY450023110	4523	1.1 mm	0.644 kg/m
Ngang cánh lùa 				Ray lùa 				T (có vít) 			
Mã mới	Mã cũ	Độ dày	Trọng lượng	Mã mới	Mã cũ	Độ dày	Trọng lượng	Mã mới	Mã cũ	Độ dày	Trọng lượng
DY440022130	DY4422	1.3 mm	0.759 kg/m	DY440040130	DY-4440	1.3 mm	1.074 kg/m	DY450023100	4523V	1.0 mm	0.643 kg/m
DY450022110	4522	0.95 mm	0.583 kg/m	Đồ lớn 				Đồ lớn (hèm nhỏ) 			
Sập 				Đồ lớn 				Đồ lớn (hèm nhỏ) 			
Mã mới	Mã cũ	Độ dày	Trọng lượng	Mã mới	Mã cũ	Độ dày	Trọng lượng	Mã mới	Mã cũ	Độ dày	Trọng lượng
DY440024100	DY4424	1.0 mm	0.256 kg/m	DY440013150	DY4413	1.5 mm	1.363 kg/m	DY700679110	4513B	1.1mm	1.069 kg/m
DY450024080	4524	0.80 mm	0.192 kg/m	DY450013125	4513	1.25 mm	1.139 kg/m	Cánh 44 (cải tiến) 			
Ray cửa lùa (chân vuông) 				Đứng cánh móc (hèm nhỏ) 				Cánh 44 (cải tiến) 			
Mã mới	Mã cũ	Độ dày	Trọng lượng	Mã mới	Mã cũ	Độ dày	Trọng lượng	Mã mới	Mã cũ	Độ dày	Trọng lượng
DY450031120	DA4520A-1	1.2 mm	0.825 kg/m	DY450014100	4512A	1.0 mm	0.788 kg/m	DYG15671120	4510C	1.2 mm	0.996 kg/m
DY450031100	DA4520A	1.0 mm	0.701 kg/m	Đứng trơn lùa 				Ray lùa 			
Mã mới	Mã cũ	Độ dày	Trọng lượng	Mã mới	Mã cũ	Độ dày	Trọng lượng	Mã mới	Mã cũ	Độ dày	Trọng lượng
DY440001150	DY4401	1.5 mm	0.819 kg/m	DY440050130	DY-4430	1.3 mm	0.987 kg/m	DY330010100	4520B	1.0 mm	0.492 kg/m
DY450001100	4501	1.0 mm	0.588 kg/m	Đồ bé (hèm nhỏ) 							
Nối khung 				Đồ bé (hèm nhỏ) 				Cánh 44 (cải tiến) 			
Mã mới	Mã cũ	Độ dày	Trọng lượng	Mã mới	Mã cũ	Độ dày	Trọng lượng	Mã mới	Mã cũ	Độ dày	Trọng lượng
DY450033120	4531A	1.2 mm	0.165 kg/m	DY700680110	4509	1.1 mm	0.715 kg/m	DY440021000	DY4421		0.133 kg/m
								DY4500045100	4510B	1.0 mm	1.109 kg/m

HỆ CỬA SỔ MỞ BẬT DY - 39

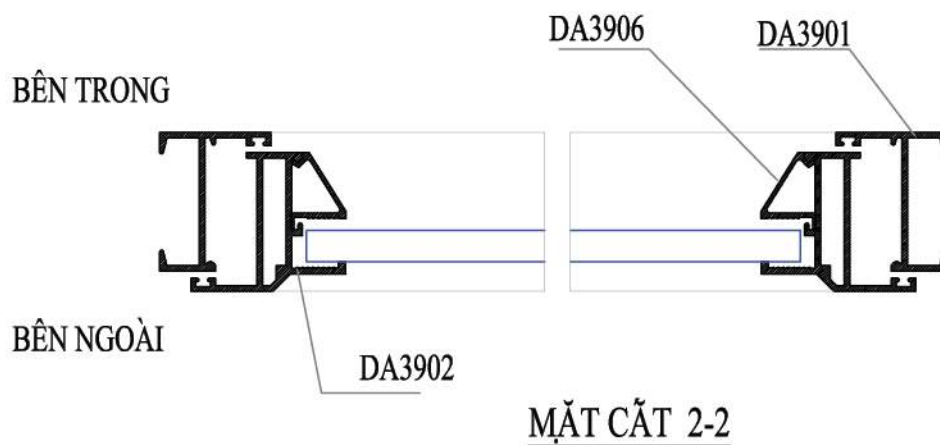
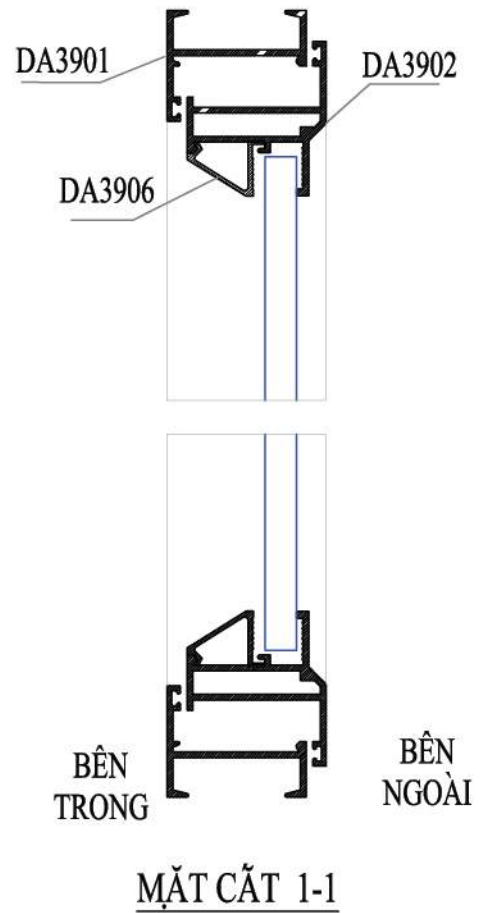
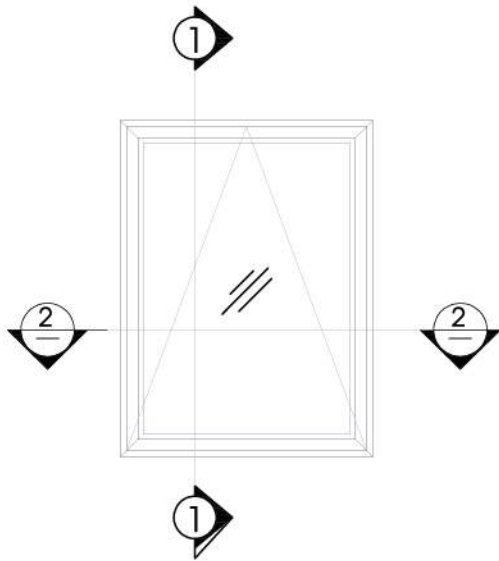

HỆ CỬA SỔ MỞ BẬT DY - 38

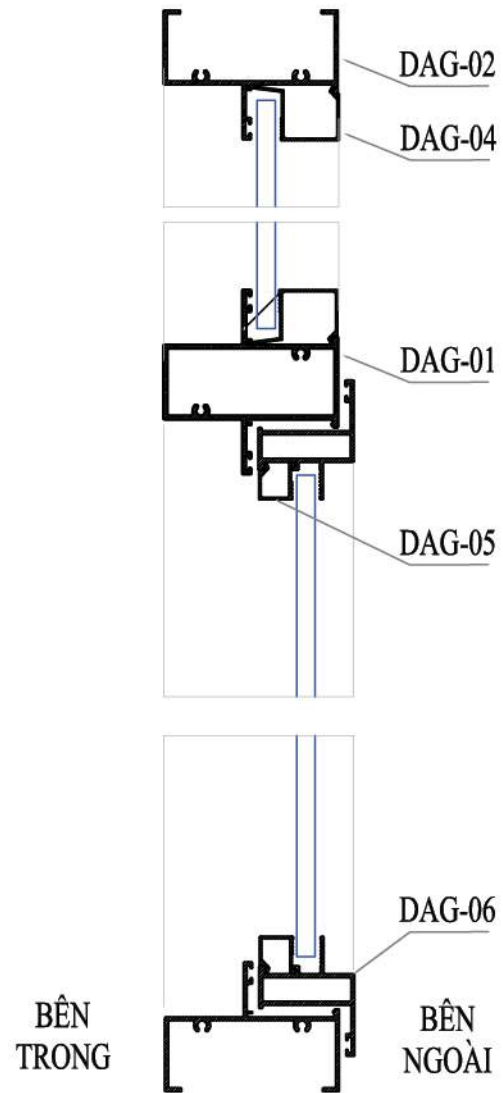
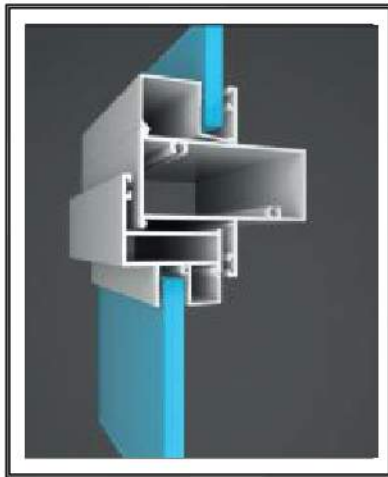
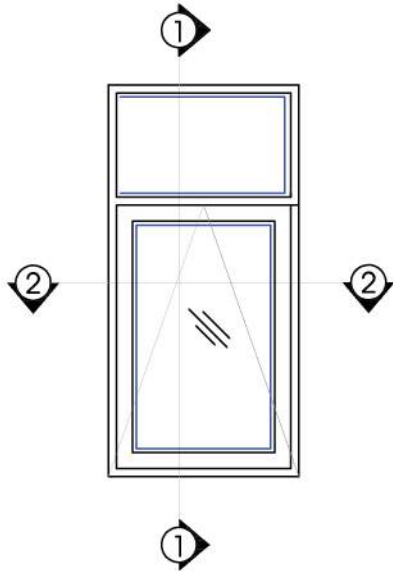

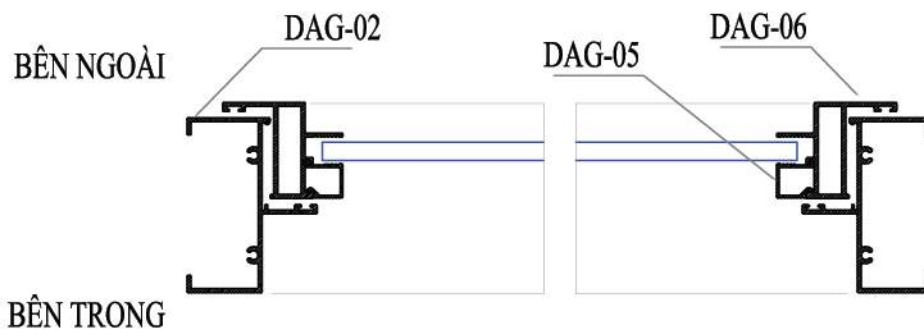

MẶT CẮT 1-1

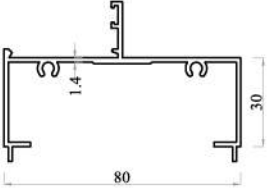
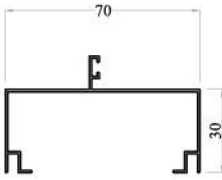
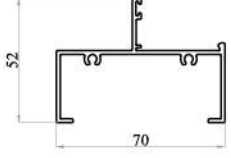
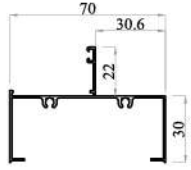
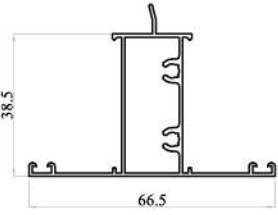
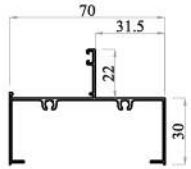
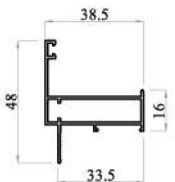

MẶT CẮT 2-2

LIST MẶT CẮT HỆ DY - 38, 39

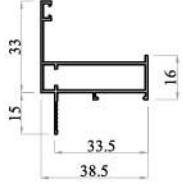
																															
Mã mới	Mã cũ	Độ dày	Trọng lượng	Mã mới	Mã cũ	Độ dày	Trọng lượng	Mã mới	Mã cũ	Độ dày	Trọng lượng																				
DY380141140	7002VH	1.4 mm	0.828 kg/m					DYG14737160	DAG-02	1.6 mm	0.82 kg/m																				
				<table border="1"> <thead> <tr> <th>Mã mới</th><th>Mã cũ</th><th>Độ dày</th><th>Trọng lượng</th></tr> </thead> <tbody> <tr> <td>DY700312110</td><td>DA7002A</td><td>1.1 mm</td><td>0.526 kg/m</td></tr> <tr> <td>DY700121100</td><td>DN-7002</td><td>1.0 mm</td><td>0.501 kg/m</td></tr> <tr> <td>DY700101080</td><td>PS7002</td><td>0.8 mm</td><td>0.448 kg/m</td></tr> <tr> <td>DY700202080</td><td>DA7002</td><td>0.8 mm</td><td>0.426 kg/m</td></tr> </tbody> </table>				Mã mới	Mã cũ	Độ dày	Trọng lượng	DY700312110	DA7002A	1.1 mm	0.526 kg/m	DY700121100	DN-7002	1.0 mm	0.501 kg/m	DY700101080	PS7002	0.8 mm	0.448 kg/m	DY700202080	DA7002	0.8 mm	0.426 kg/m				
Mã mới	Mã cũ	Độ dày	Trọng lượng																												
DY700312110	DA7002A	1.1 mm	0.526 kg/m																												
DY700121100	DN-7002	1.0 mm	0.501 kg/m																												
DY700101080	PS7002	0.8 mm	0.448 kg/m																												
DY700202080	DA7002	0.8 mm	0.426 kg/m																												
Mã mới	Mã cũ	Độ dày	Trọng lượng	Mã mới	Mã cũ	Độ dày	Trọng lượng	Mã mới	Mã cũ	Độ dày	Trọng lượng																				
DY380112180	DA3904B	1.8 mm	0.861 kg/m	DY700601070	DY7002	0.7 mm	0.42 kg/m	DY380113090	DA3904A	0.9 mm	0.529 kg/m																				
																															
Mã mới	Mã cũ	Độ dày	Trọng lượng	Mã mới	Mã cũ	Độ dày	Trọng lượng	Mã mới	Mã cũ	Độ dày	Trọng lượng																				
				DY380111090	DA3904	0.9 mm	0.489 kg/m	DY380002100	DA3802	1.0 mm	0.403 kg/m																				
																															
Mã mới	Mã cũ	Độ dày	Trọng lượng	Mã mới	Mã cũ	Độ dày	Trọng lượng	Mã mới	Mã cũ	Độ dày	Trọng lượng																				
DY380131090	DA3907	0.9 mm	0.463 kg/m	DY380112090	DA3902A	0.9 mm	0.52 kg/m	DY380102090	DA3902	0.9 mm	0.364 kg/m																				
Mã mới	Mã cũ	Độ dày	Trọng lượng	Mã mới	Mã cũ	Độ dày	Trọng lượng	Mã mới	Mã cũ	Độ dày	Trọng lượng																				

LIST MẶT CẮT HỆ DY - 38, 39

Mã mới	Mã cũ	Độ dày	Trọng lượng	Mã mới	Mã cũ	Độ dày	Trọng lượng	Mã mới	Mã cũ	Độ dày	Trọng lượng
DYG14735160	DAG-06	1.6 mm	0.628 kg/m	DY380104090	DA3906	0.9 mm	0.104 kg/m	DY380004080	3814	0.8 mm	0.116 kg/m
Mã mới	Mã cũ	Độ dày	Trọng lượng	Mã mới	Mã cũ	Độ dày	Trọng lượng	Mã mới	Mã cũ	Độ dày	Trọng lượng
DY380103090	DA3903	0.9 mm	0.436 kg/m	DYG14734100	DAG-05	1.0 mm	1.131 kg/m	DYG14733100	DAG-04	1.0 mm	0.224 kg/m
Mã mới	Mã cũ	Độ dày	Trọng lượng	Mã mới	Mã cũ	Độ dày	Trọng lượng	Mã mới	Mã cũ	Độ dày	Trọng lượng
DY380001100	DA3801	1.0 mm	0.293 kg/m	DY380105090	DA3905	0.9 mm	0.173 kg/m	DY380115100	3095VH	1.0 mm	0.198 kg/m
Mã mới	Mã cũ	Độ dày	Trọng lượng	Mã mới	Mã cũ	Độ dày	Trọng lượng	Mã mới	Mã cũ	Độ dày	Trọng lượng
DY380101090	DA3901	0.9 mm	0.267 kg/m	DY380119090	DA3908	0.9 mm	0.285 kg/m	DYG14736160	DAG-01	1.6 mm	1.208 kg/m
Mã mới	Mã cũ	Độ dày	Trọng lượng	Mã mới	Mã cũ	Độ dày	Trọng lượng	Mã mới	Mã cũ	Độ dày	Trọng lượng
DY380109090	DA3901A	0.9 mm	0.166 kg/m	DYG14732130	DAG-03	1.3 mm	0.63 kg/m	DY380003100	DA3803	1.0 mm	0.486 kg/m

HỆ CỬA SỔ LỬA DY - 500

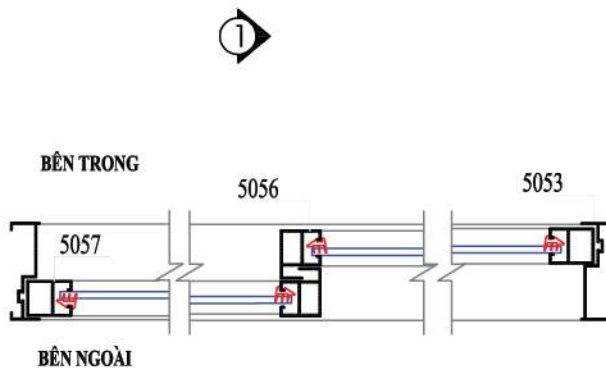
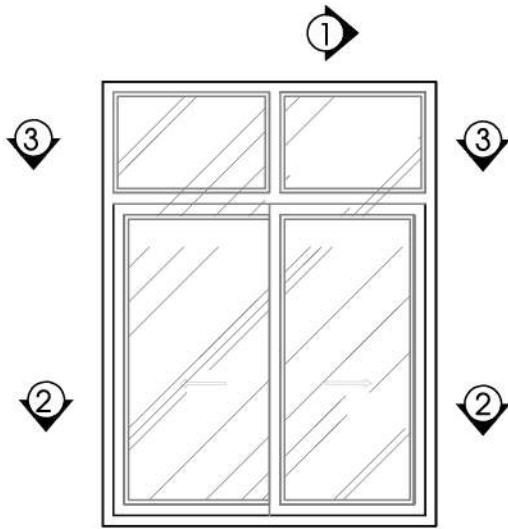

MẶT CẮT 2-2

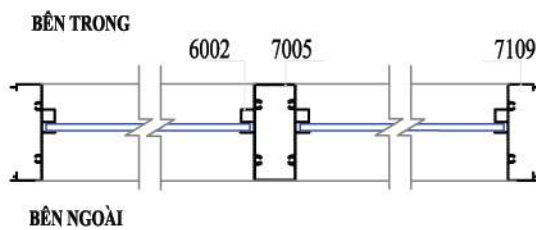

MẶT CẮT 3-3

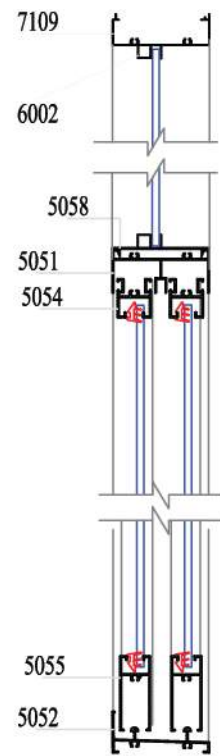

MẶT CẮT 1-1

LIST MẶT CẮT HỆ DY - 500

Mã mới	Mã cũ	Độ dày	Trọng lượng	Mã mới	Mã cũ	Độ dày	Trọng lượng	Mã mới	Mã cũ	Độ dày	Trọng lượng						
DY700009100	DN-5058	1.0 mm	0.247 kg/m	DY700002110	DA5002	1.1 mm	0.507 kg/m	DY700001110	DA5001	1.1 mm	0.609 kg/m						
				DY700032090				DN-5052	0.9 mm	0.479 kg/m	DY700031090				DN-5051	0.9 mm	0.532 kg/m
DY700022080				PS5052	0.8 mm	0.432 kg/m	DY700021080				PS5051	0.8 mm	0.486 kg/m				
DY700032070				DY5052	0.7 mm	0.379 kg/m	DY700031070				DY5051	0.7 mm	0.431 kg/m				
DY700012070				DA5002B	0.7 mm	0.367 kg/m	DY700011060				DA5001B	0.6 mm	0.377 kg/m				
Mã mới	Mã cũ	Độ dày	Trọng lượng	Mã mới	Mã cũ	Độ dày	Trọng lượng	Mã mới	Mã cũ	Độ dày	Trọng lượng						
DYG13445060	DAB.12B	0.6 mm	0.358 kg/m	DY700003110	DA5003	1.1 mm	0.42 kg/m	DY700004110	DA5004	1.1 mm	0.333 kg/m						
				DY700033090				DN-5053	0.9 mm	0.343 kg/m	DY700034089				DN-5054	0.89 mm	0.28 kg/m
DY700023080				PS5053	0.8 mm	0.308 kg/m	DY700024075				PS5054	0.75 mm	0.248 kg/m				
DY700033070				DY5053	0.7 mm	0.282 kg/m	DY700034065				DY5054	0.65 mm	0.204 kg/m				
DY700013060				DA5003B	0.6 mm	0.234 kg/m	DY700014060				DA5004B	0.6 mm	0.201 kg/m				
Mã mới	Mã cũ	Độ dày	Trọng lượng	Mã mới	Mã cũ	Độ dày	Trọng lượng	Mã mới	Mã cũ	Độ dày	Trọng lượng						
DYG14867060	DAB-12C	0.6	0.358 kg/m	DY700007110	DA5007	1.1 mm	0.429 kg/m	DY700006110	DA5006	1.1 mm	0.375 kg/m						
				DY700036090				DN-5056	0.9 mm	0.353 kg/m	DY700037085				DN-5057	0.85 mm	0.291 kg/m
DY700026075				PS5056	0.75 mm	0.297 kg/m	DY700027075				PS5057	0.75 mm	0.26 kg/m				
DY700037065				DY5056	0.65 mm	0.259 kg/m	DY700036065				DY5057	0.65 mm	0.223 kg/m				
DY700017060				DA5007B	0.6 mm	0.24 kg/m	DY700016060				DA5006B	0.6 mm	0.211 kg/m				
Mã mới	Mã cũ	Độ dày	Trọng lượng	Mã mới	Mã cũ	Độ dày	Trọng lượng	Mã mới	Mã cũ	Độ dày	Trọng lượng						
DY7000416060	DAB-09	0.6 mm	0.271 kg/m	DY700005110	DA5005	1.1 mm	0.462 kg/m	DY700008110	DA5008	1.1 mm	0.247 kg/m						
				DY700035090				DN-5055	0.9 mm	0.383 kg/m	DY700018070				DY5126	0.7 mm	0.16 kg/m
DY700025075				PS5005	0.75 mm	0.34 kg/m	DY700018060				DA5008B	0.6 mm	0.141 kg/m				
DY700035072				DY5055	0.72 mm	0.302 kg/m											
Mã mới	Mã cũ	Độ dày	Trọng lượng														
DYG12343060	DAB-12	0.6 mm	0.358 kg/m														

HỆ CỬA SỔ LỬA DY - 702

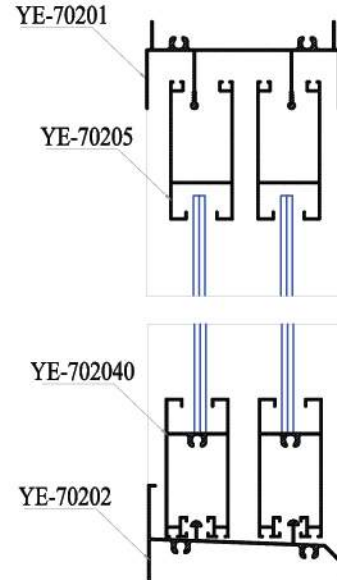
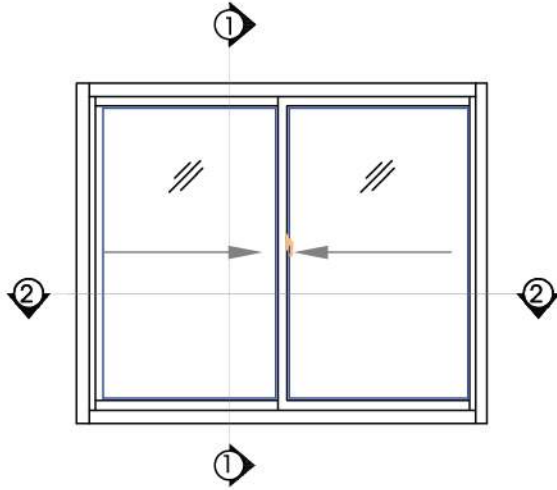

BÊN TRONG

BÊN NGOÀI

MẶT CẮT 1-1

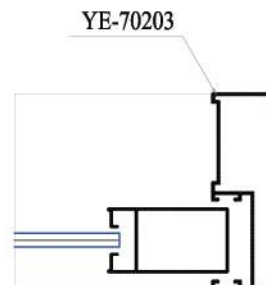
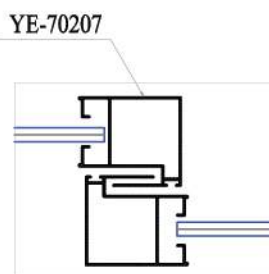
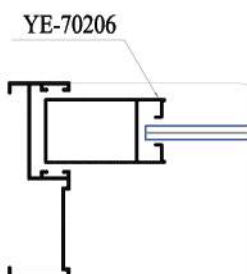

BÊN TRONG

BÊN NGOÀI

MẶT CẮT 2-2

LIST MẶT CẮT HỆ DY - 702

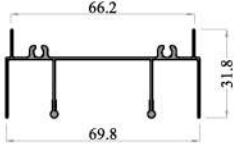
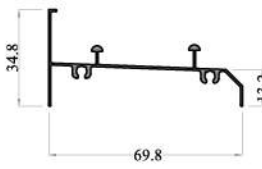
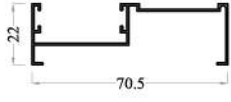
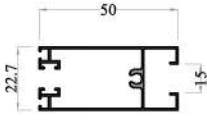
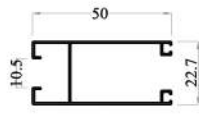
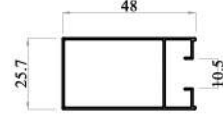
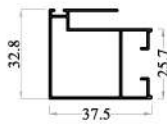
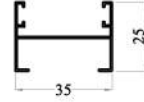
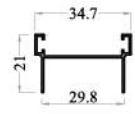
											
Mã mới	Mã cũ	Độ dày	Trọng lượng	Mã mới	Mã cũ	Độ dày	Trọng lượng	Mã mới	Mã cũ	Độ dày	Trọng lượng
DY700401070	YE-70201	0.7 mm	0.43 kg/m	DY700402070	YE-70202	0.7 mm	0.349 kg/m	DY700403070	YE-70203	0.7 mm	0.29 kg/m
											
Mã mới	Mã cũ	Độ dày	Trọng lượng	Mã mới	Mã cũ	Độ dày	Trọng lượng	Mã mới	Mã cũ	Độ dày	Trọng lượng
DY700404060	YE-70204	0.6 mm	0.326 kg/m	DY700405060	YE-70205	0.6 mm	0.25 kg/m	DY700406060	YE-70206	0.6 mm	0.27 kg/m
											
Mã mới	Mã cũ	Độ dày	Trọng lượng	Mã mới	Mã cũ	Độ dày	Trọng lượng	Mã mới	Mã cũ	Độ dày	Trọng lượng
DY700407060	YE-70207	0.6 mm	0.29 kg/m	DY700408070	YE-70208	0.7 mm	0.29 kg/m	DY700418070	YE-70209	0.7 mm	0.164 kg/m
Mã mới	Mã cũ	Độ dày	Trọng lượng	Mã mới	Mã cũ	Độ dày	Trọng lượng	Mã mới	Mã cũ	Độ dày	Trọng lượng
Mã mới	Mã cũ	Độ dày	Trọng lượng	Mã mới	Mã cũ	Độ dày	Trọng lượng	Mã mới	Mã cũ	Độ dày	Trọng lượng

HỆ CỬA SỔ LỬA DY - 720

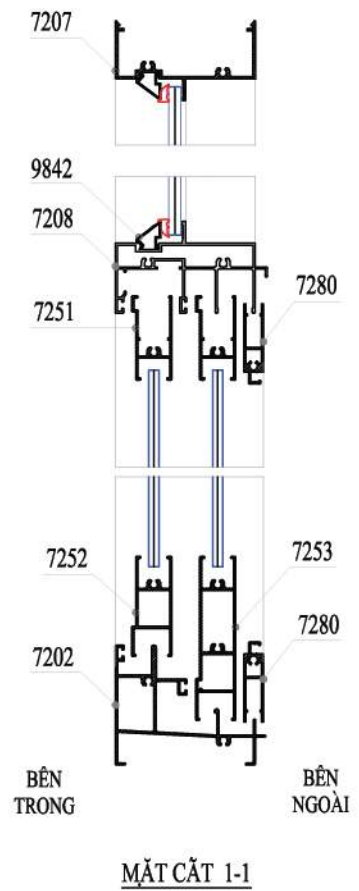
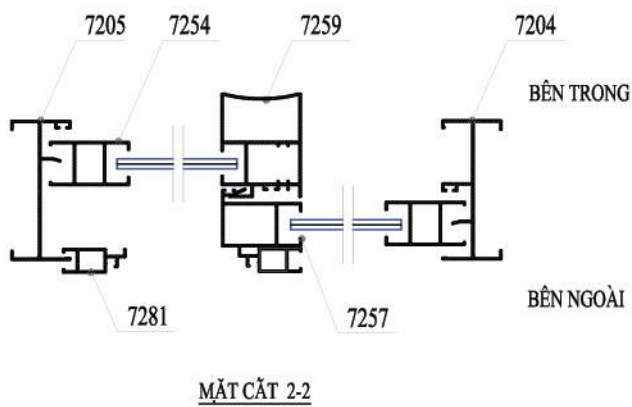
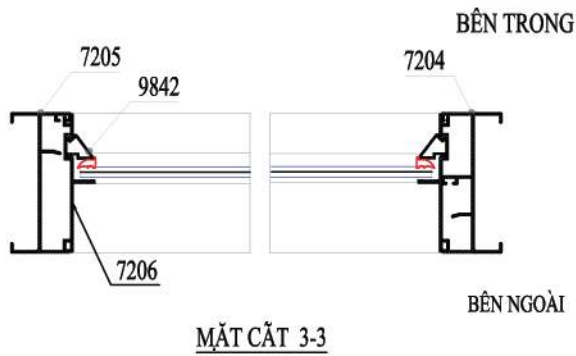
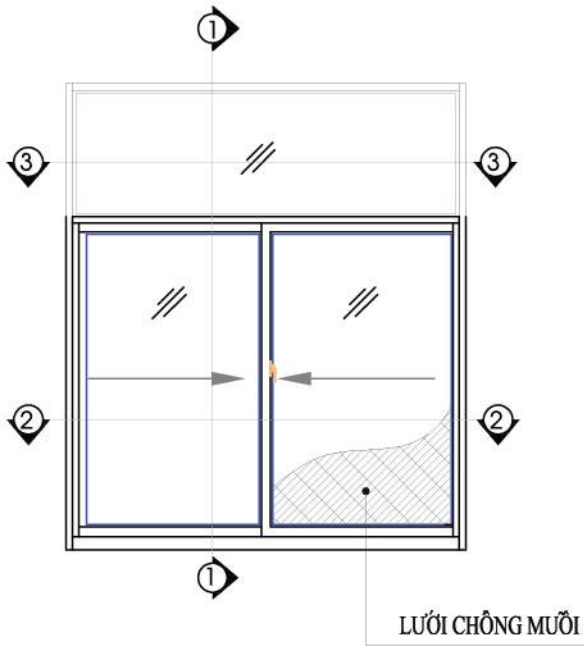

LIST MẶT CẮT HỆ DY - 720

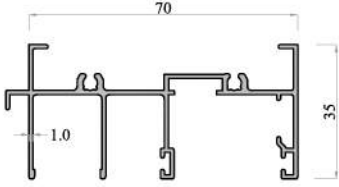
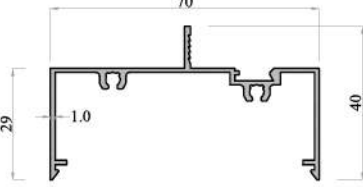
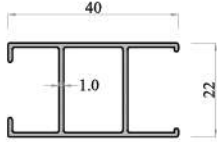
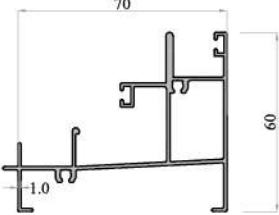
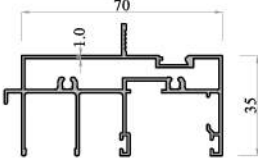
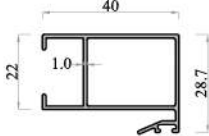
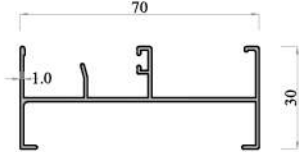
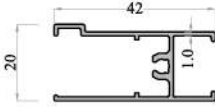
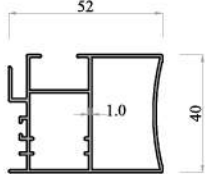
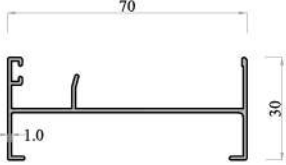
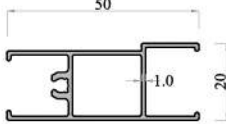
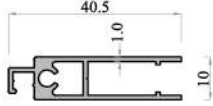
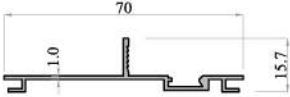
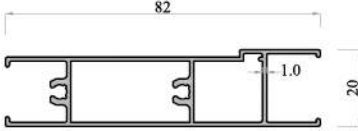
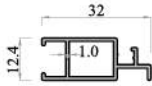
											
Mã mới	Mã cũ	Độ dày	Trọng lượng	Mã mới	Mã cũ	Độ dày	Trọng lượng	Mã mới	Mã cũ	Độ dày	Trọng lượng
DY700501100	7201	1.0 mm	0.73 kg/m	DY700509100	7207	1.0 mm	0.547 kg/m	DY700506100	7254	1.0 mm	0.349 kg/m
											
Mã mới	Mã cũ	Độ dày	Trọng lượng	Mã mới	Mã cũ	Độ dày	Trọng lượng	Mã mới	Mã cũ	Độ dày	Trọng lượng
DY700502100	7202	1.0 mm	0.919 kg/m	DY700511100	7208	1.0 mm	0.966 kg/m	DY700507100	7257	1.0 mm	0.398 kg/m
											
Mã mới	Mã cũ	Độ dày	Trọng lượng	Mã mới	Mã cũ	Độ dày	Trọng lượng	Mã mới	Mã cũ	Độ dày	Trọng lượng
DY700503100	7204	1.0 mm	0.491 kg/m	DY700505100	7251	1.0 mm	0.336 kg/m	DY700517100	7259	1.0 mm	0.684 kg/m
											
Mã mới	Mã cũ	Độ dày	Trọng lượng	Mã mới	Mã cũ	Độ dày	Trọng lượng	Mã mới	Mã cũ	Độ dày	Trọng lượng
DY700513100	7205	1.0 mm	0.441 kg/m	DY700504100	7252	1.0 mm	0.416 kg/m	DY700510100	7280	1.0 mm	0.315 kg/m
											
Mã mới	Mã cũ	Độ dày	Trọng lượng	Mã mới	Mã cũ	Độ dày	Trọng lượng	Mã mới	Mã cũ	Độ dày	Trọng lượng
DY700519100	7206	1.0 mm	0.304 kg/m	DY700514100	7253	1.0 mm	0.681 kg/m	DY700520100	7281	1.0 mm	0.288 kg/m

LIST MẶT CẮT HỆ DY - 720

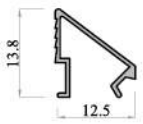
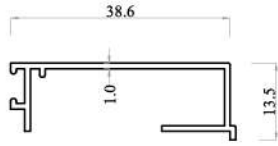
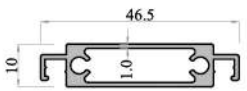
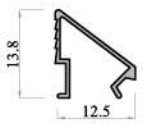
											
Mã mới	Mã cũ	Độ dày	Trọng lượng	Mã mới	Mã cũ	Độ dày	Trọng lượng	Mã mới	Mã cũ	Độ dày	Trọng lượng
DYT10059070	DY9842	0.6 mm	0.066 kg/m	DY700529100	7283	1.0 mm	0.215 kg/m	DY700530100	7282	1.0 mm	0.391 kg/m
											
Mã mới	Mã cũ	Độ dày	Trọng lượng	Mã mới	Mã cũ	Độ dày	Trọng lượng	Mã mới	Mã cũ	Độ dày	Trọng lượng
DYT10028065	SY-9842	0.65 mm	0.07 kg/m								
Mã mới	Mã cũ	Độ dày	Trọng lượng	Mã mới	Mã cũ	Độ dày	Trọng lượng	Mã mới	Mã cũ	Độ dày	Trọng lượng
Mã mới	Mã cũ	Độ dày	Trọng lượng	Mã mới	Mã cũ	Độ dày	Trọng lượng	Mã mới	Mã cũ	Độ dày	Trọng lượng
Mã mới	Mã cũ	Độ dày	Trọng lượng	Mã mới	Mã cũ	Độ dày	Trọng lượng	Mã mới	Mã cũ	Độ dày	Trọng lượng

HỆ CỬA SỔ LÙA DY - 780

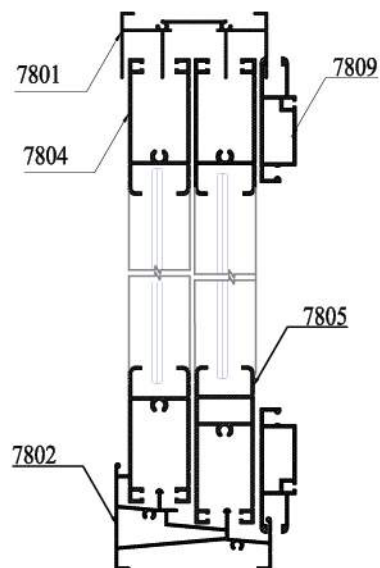
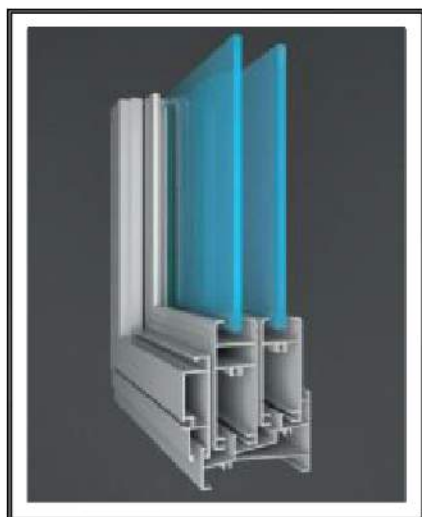
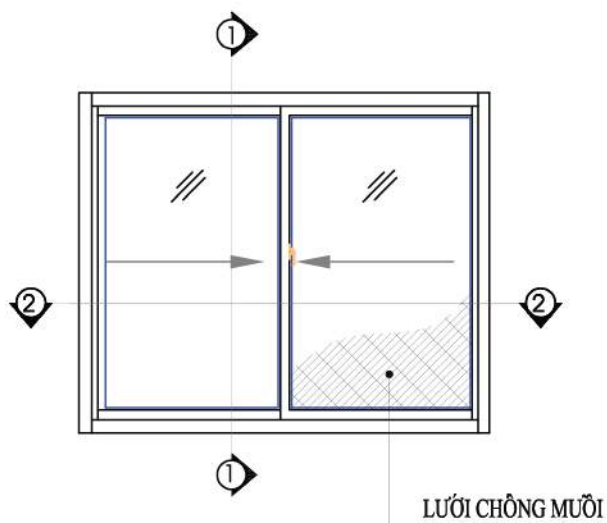

BÊN TRONG

BÊN NGOÀI

MẶT CẮT 1-1

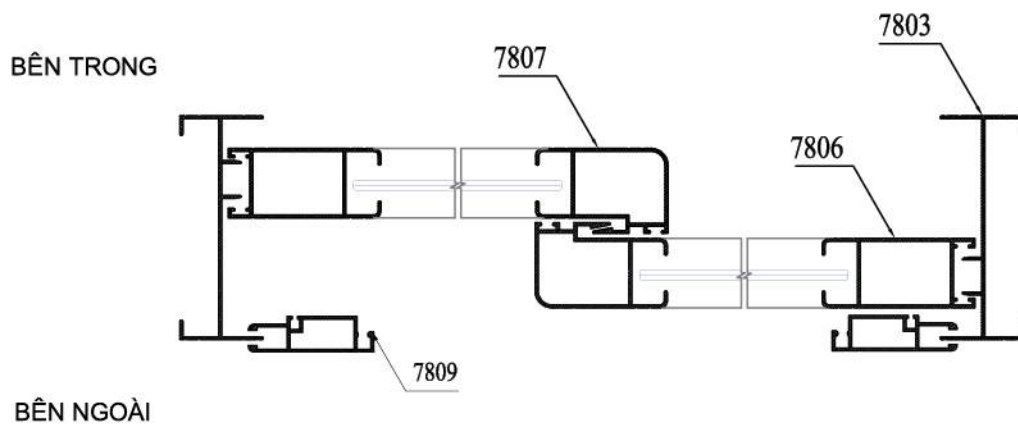

MẶT CẮT 2-2

LIST MẶT CẮT HỆ DY - 780

Mã mới	Mã cũ	Độ dày	Trọng lượng	Mã mới	Mã cũ	Độ dày	Trọng lượng	Mã mới	Mã cũ	Độ dày	Trọng lượng
DY780001100	7801	1.0 mm	0.636 kg/m	DY780002100	7802	1.0 mm	0.802 kg/m	DY780003100	7803	1.0 mm	0.435 kg/m
Mã mới	Mã cũ	Độ dày	Trọng lượng	Mã mới	Mã cũ	Độ dày	Trọng lượng	Mã mới	Mã cũ	Độ dày	Trọng lượng
DY780004100	7804	1.0 mm	0.4 kg/m	DY780012100	7802KA	1.0 mm	0.626 kg/m	DY780013100	7803A	1.0 mm	0.65 kg/m
Mã mới	Mã cũ	Độ dày	Trọng lượng	Mã mới	Mã cũ	Độ dày	Trọng lượng	Mã mới	Mã cũ	Độ dày	Trọng lượng
DY780014100	7804A	1.0 mm	0.435 kg/m	DY780006100	7806	1.0 mm	0.47 kg/m	DY780023100	7803D	1.2 mm	0.71 kg/m
Mã mới	Mã cũ	Độ dày	Trọng lượng	Mã mới	Mã cũ	Độ dày	Trọng lượng	Mã mới	Mã cũ	Độ dày	Trọng lượng
DY780005100	7805	1.0 mm	0.516 kg/m	DY780016100	7806A	1.0 mm	0.5 kg/m	DY780007100	7807	1.0 mm	0.478 kg/m
Mã mới	Mã cũ	Độ dày	Trọng lượng	Mã mới	Mã cũ	Độ dày	Trọng lượng	Mã mới	Mã cũ	Độ dày	Trọng lượng
DY780015100	7805	1.0 mm	0.54 kg/m	DY780070080	7815	0.8 mm	0.1 kg/m	DY780017100	7807A	1.0 mm	0.5 kg/m

LIST MẶT CẮT HỆ DY - 780

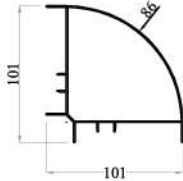
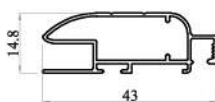
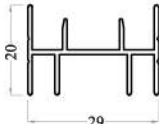
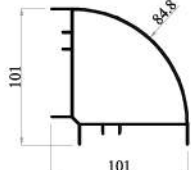
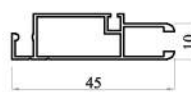
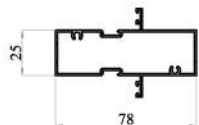
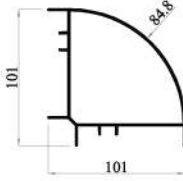
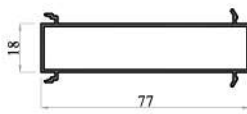
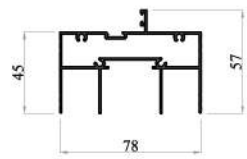
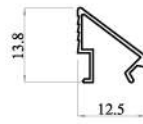
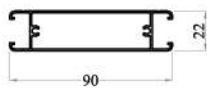
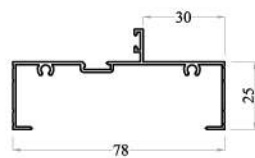
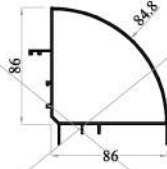
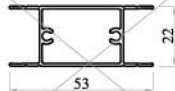
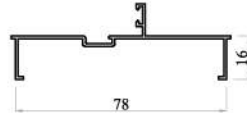
											
Mã mới	Mã cũ	Độ dày	Trọng lượng	Mã mới	Mã cũ	Độ dày	Trọng lượng	Mã mới	Mã cũ	Độ dày	Trọng lượng
DY780020100	7810B	1.0 mm	1.04 kg/m	DY780019080	7809D	0.8 mm	0.286 kg/m	DY780008100	7888	1.0 mm	0.259 kg/m
											
Mã mới	Mã cũ	Độ dày	Trọng lượng	Mã mới	Mã cũ	Độ dày	Trọng lượng	Mã mới	Mã cũ	Độ dày	Trọng lượng
DY780030100	7810G	1.0 mm	1.04 kg/m	DY780009090	7809	0.9 mm	0.31 kg/m	DY780049100	7818	1.0 mm	0.752 kg/m
											
Mã mới	Mã cũ	Độ dày	Trọng lượng	Mã mới	Mã cũ	Độ dày	Trọng lượng	Mã mới	Mã cũ	Độ dày	Trọng lượng
DY780040100	7810H	1.0 mm	0.99 kg/m	DY780028100	7812	1.0 mm	0.575 kg/m	DY780011100	7821	1.0 mm	1.013 kg/m
											
Mã mới	Mã cũ	Độ dày	Trọng lượng	Mã mới	Mã cũ	Độ dày	Trọng lượng	Mã mới	Mã cũ	Độ dày	Trọng lượng
DYT10028065	SY-9842	0.65 mm	0.07 kg/m	DY780059100	7828	1.0 mm	0.693 kg/m	DY780029100	7811	1.0 mm	0.286 kg/m
											
Mã mới	Mã cũ	Độ dày	Trọng lượng	Mã mới	Mã cũ	Độ dày	Trọng lượng	Mã mới	Mã cũ	Độ dày	Trọng lượng
DY780060100	7810U	1.0 mm	1.007 kg/m	DY780069100	7832A	1.0 mm	0.443 kg/m	DY780039100	7813	1.0 mm	0.384 kg/m

HỆ CỬA SỔ MỞ BẬT DY - 800

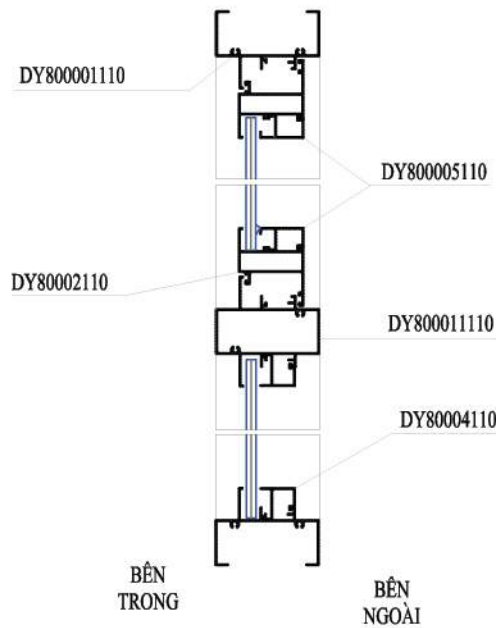
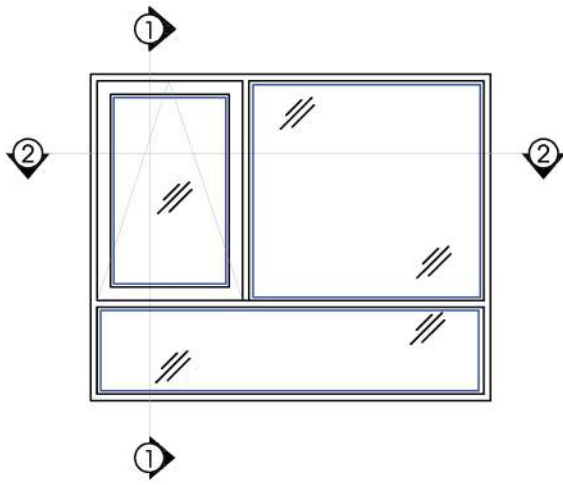

MẶT CẮT 1-1

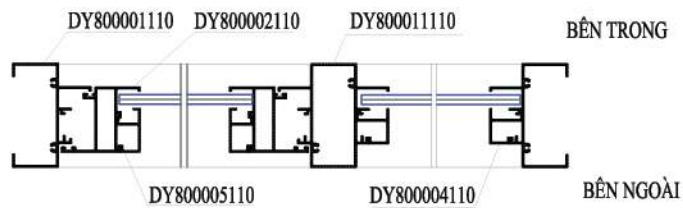

MẶT CẮT 2-2

LIST MẶT CẮT HỆ DY - 800

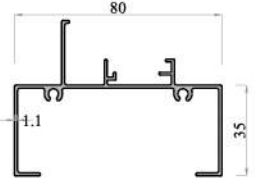
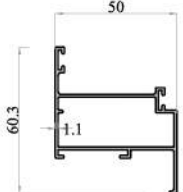
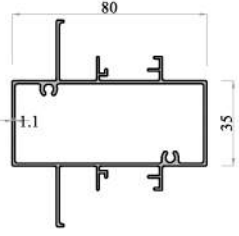
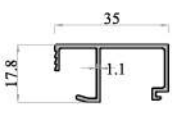
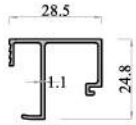
											
Mã mới	Mã cũ	Độ dày	Trọng lượng	Mã mới	Mã cũ	Độ dày	Trọng lượng	Mã mới	Mã cũ	Độ dày	Trọng lượng
DY800001110		1.1 mm	0.761 kg/m	DY800002110		1.1 mm	0.638 kg/m	DY800011110		1.1 mm	1.114 kg/m
											
Mã mới	Mã cũ	Độ dày	Trọng lượng	Mã mới	Mã cũ	Độ dày	Trọng lượng	Mã mới	Mã cũ	Độ dày	Trọng lượng
DY800005110		1.1 mm	0.258 kg/m	DY800004110		1.1 mm	0.256 kg/m				
Mã mới	Mã cũ	Độ dày	Trọng lượng	Mã mới	Mã cũ	Độ dày	Trọng lượng	Mã mới	Mã cũ	Độ dày	Trọng lượng
Mã mới	Mã cũ	Độ dày	Trọng lượng	Mã mới	Mã cũ	Độ dày	Trọng lượng	Mã mới	Mã cũ	Độ dày	Trọng lượng
Mã mới	Mã cũ	Độ dày	Trọng lượng	Mã mới	Mã cũ	Độ dày	Trọng lượng	Mã mới	Mã cũ	Độ dày	Trọng lượng

HỆ CỬA SỔ LỬA DY - 890

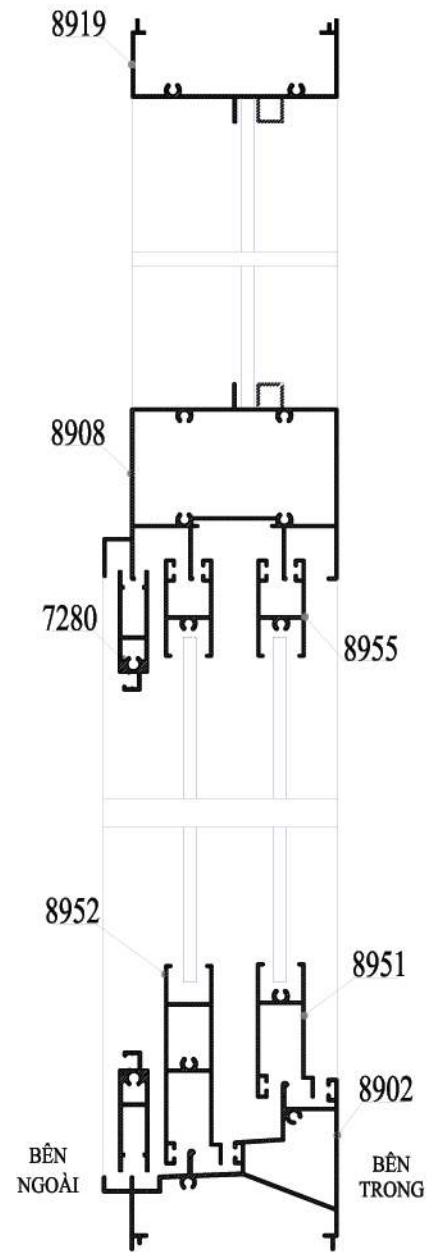
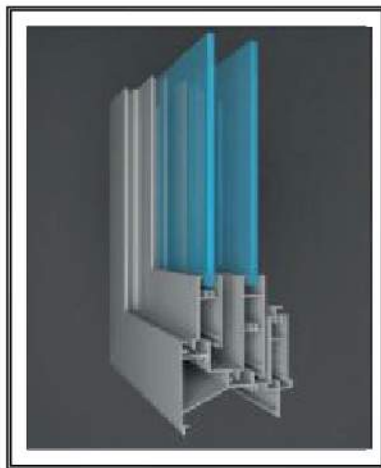
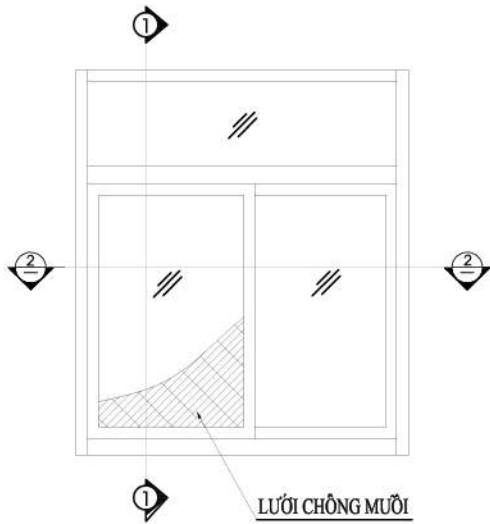

MẶT CẮT 1-1

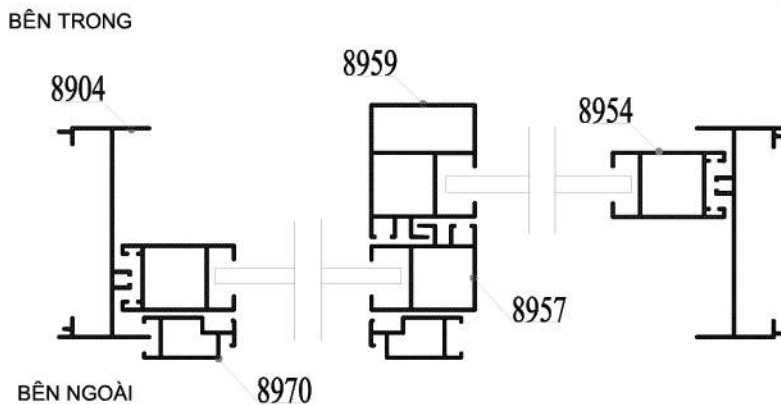

MẶT CẮT 2-2

LIST MẶT CẮT HỆ DY - 890

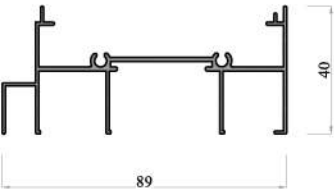
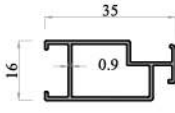
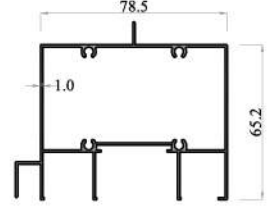
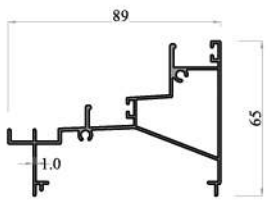
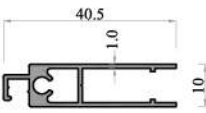
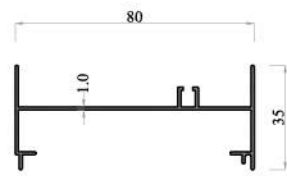
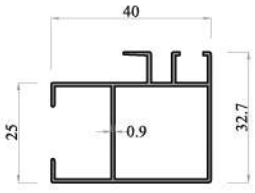
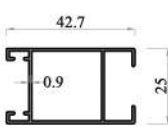
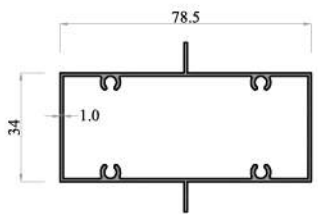
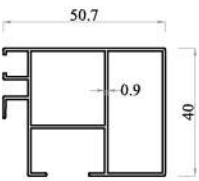
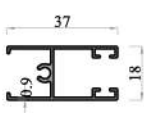
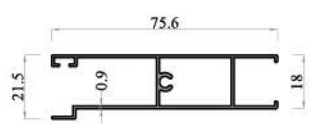
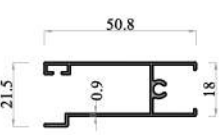
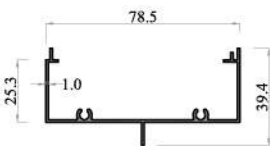
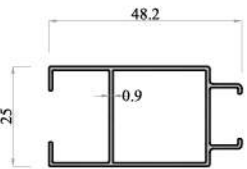
											
Mã mới	Mã cũ	Độ dày	Trọng lượng	Mã mới	Mã cũ	Độ dày	Trọng lượng	Mã mới	Mã cũ	Độ dày	Trọng lượng
DY890001100	8901	1.0 mm	0.780 kg/m	DY890010090	8970	0.9 mm	0.258 kg/m	DY890011100	8908	1.1 mm	1.119 kg/m
											
Mã mới	Mã cũ	Độ dày	Trọng lượng	Mã mới	Mã cũ	Độ dày	Trọng lượng	Mã mới	Mã cũ	Độ dày	Trọng lượng
DY890002100	8902	1.0 mm	0.962 kg/m	DY700510100	7280	1.0 mm	0.315 kg/m	DY890003100	8904	1.0 mm	0.487 kg/m
											
Mã mới	Mã cũ	Độ dày	Trọng lượng	Mã mới	Mã cũ	Độ dày	Trọng lượng	Mã mới	Mã cũ	Độ dày	Trọng lượng
DY890007090	8957	0.9 mm	0.408 kg/m	DY890006090	8954	0.9 mm	0.376 kg/m	DY890019100	8905	1.0 mm	0.776 kg/m
											
Mã mới	Mã cũ	Độ dày	Trọng lượng	Mã mới	Mã cũ	Độ dày	Trọng lượng	Mã mới	Mã cũ	Độ dày	Trọng lượng
DY890017090	8959	0.9 mm	0.593 kg/m	DY890004090	8955	0.9 mm	0.308 kg/m	DY890015090	8952	0.9 mm	0.523 kg/m
											
Mã mới	Mã cũ	Độ dày	Trọng lượng	Mã mới	Mã cũ	Độ dày	Trọng lượng	Mã mới	Mã cũ	Độ dày	Trọng lượng
DY890005090	8951	0.9 mm	0.360 kg/m	DY890009100	8919	1.0 mm	0.492 kg/m	DY890016090	8954A	0.9 mm	0.381 kg/m

HỆ CỬA ĐI MỞ QUAY DY - 700

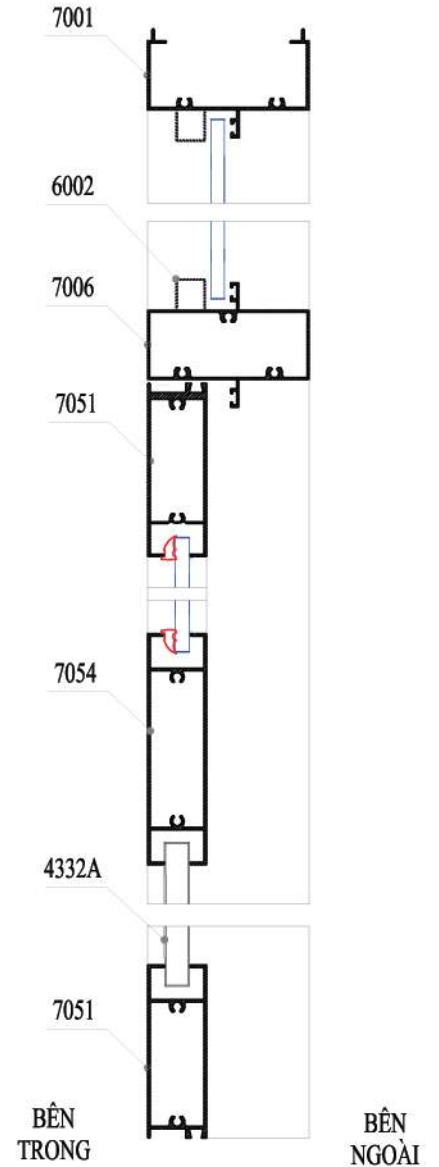
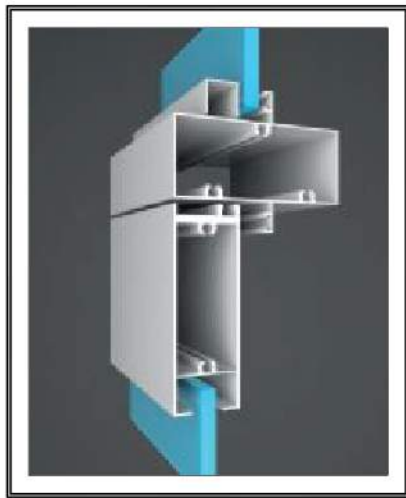
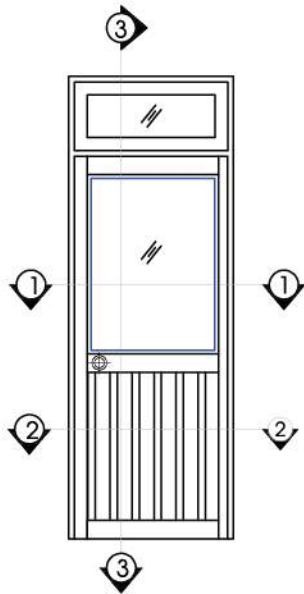

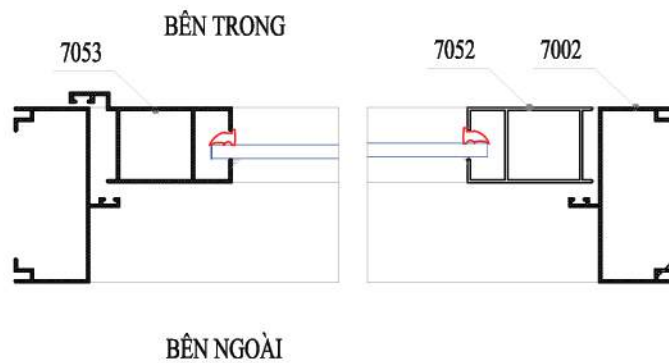

MẶT CẮT 3-3

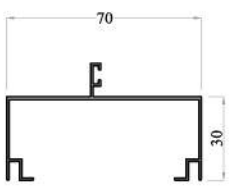
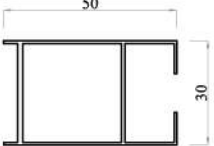
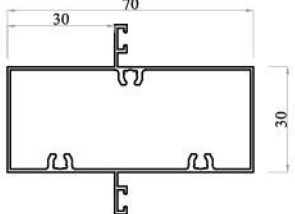
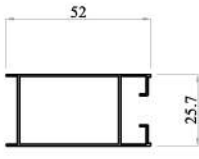
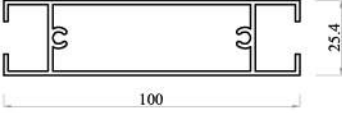
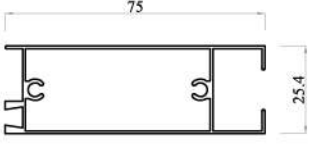
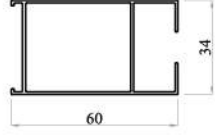
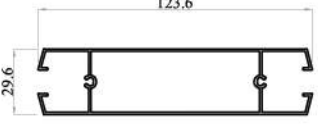
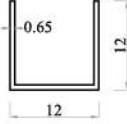
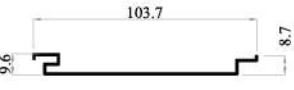
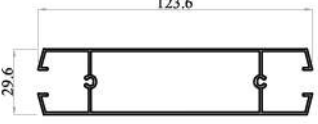
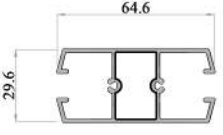

MẶT CẮT 1-1

LIST MẶT CẮT HỆ DY - 700

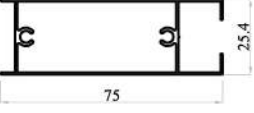
Vách				Đứng tron				Đố T						
														
Mã mới	Mã cũ	Độ dày	Trọng lượng	Mã mới	Mã cũ	Độ dày	Trọng lượng	Mã mới	Mã cũ	Độ dày	Trọng lượng			
DY700312110	DA7002A	1.1 mm	0.526 kg/m	DY700113115	DN-7052	1.15 mm	0.566 kg/m	DY700112085	DSY-7006	0.85 mm	0.668 kg/m			
DY700121100	DN-7002	1.0 mm	0.501 kg/m	DY700313110	DA7003A	1.1 mm	0.512 kg/m	DY700619070	DY7006	0.7 mm	0.546 kg/m			
DY700101080	PS7002	0.8 mm	0.448 kg/m	DY700103080	PS7052	0.8 mm	0.488 kg/m	Đứng tron 						
DY700202080	DA7002	0.8 mm	0.426 kg/m	DY700203080	DA7003	0.8 mm	0.415 kg/m							
DY700302060	DA7002B	0.6 mm	0.375 kg/m	DY700603070	DY7052	0.7 mm	0.41 kg/m							
DY700601070	DY7002	0.7 mm	0.42 kg/m	DY700303065	DA7003B	0.65 mm	0.331 kg/m							
Đố ngang 				Ngang cánh 					Mã mới	Mã cũ	Độ dày	Trọng lượng		
DY700009060	DAB-10	0.6 mm	0.307 kg/m											
Mã mới	Mã cũ	Độ dày	Trọng lượng	Mã mới	Mã cũ	Độ dày	Trọng lượng	Mã mới	Mã cũ	Độ dày	Trọng lượng			
DY700116120	DN-7054	1.2 mm	0.956 kg/m	DY700115120	DN-7051	1.1 mm	0.78 kg/m	DY710003100	DY-70103	1.0 mm	0.632 kg/m			
DY700316110	DA7006A	1.1 mm	0.878 kg/m	DY700315110	DA7005A	1.1 mm	0.719 kg/m	Đố ngang 						
DY700106080	PS7054	0.8 mm	0.671 kg/m	DY700205080	DA7005	1.0 mm	0.663 kg/m							
DY700606070	DY7054	0.7 mm	0.603 kg/m	DY700105080	PS7051	0.8 mm	0.58 kg/m	Mã mới	Mã cũ	Độ dày	Trọng lượng			
DY700306070	DA7006B	0.7 mm	0.58 kg/m	DYT10067055	DA7005B	0.6 mm	0.437 kg/m	DYT10067055	DY6002	0.55	0.052 kg/m			
								DYT10033065	SY-6002	0.65 mm	0.061 kg/m			
Mã mới	Mã cũ	Độ dày	Trọng lượng	Mã mới	Mã cũ	Độ dày	Trọng lượng	Mã mới	Mã cũ	Độ dày	Trọng lượng			
DYT10047060	NDAYE-90B	0.6 mm	0.22 kg/m	DY700679110	4513B	1.1 mm	1.069 kg/m							
								Mã mới				Mã cũ	Độ dày	Trọng lượng
DYT10048060	NDAYE-108B	0.6 mm	0.215 kg/m	DY700604075	DY7051	0.75 mm	0.486 kg/m	DY700680110	4509	1.1 mm	0.715 kg/m			

LIST MẶT CẮT HỆ DY - 700

Mã mới	Mã cũ	Độ dày	Trọng lượng	Mã mới	Mã cũ	Độ dày	Trọng lượng	Mã mới	Mã cũ	Độ dày	Trọng lượng
DYT10060055	DY4221	0.55 mm	0.198 kg/m	DYT10061050	DY4222	0.5 mm	0.178 kg/m	DYT10029070	SY-4223	0.7	0.255 kg/m
Mã mới	Mã cũ	Độ dày	Trọng lượng	Mã mới	Mã cũ	Độ dày	Trọng lượng	Mã mới	Mã cũ	Độ dày	Trọng lượng
DYT10031090	DN-4223	0.9	0.315 kg/m	DYT10062060	DY4223	0.6 mm	0.226 kg/m	DYT10017070	YE-108	0.7 mm	0.245 kg/m
Mã mới	Mã cũ	Độ dày	Trọng lượng	Mã mới	Mã cũ	Độ dày	Trọng lượng	Mã mới	Mã cũ	Độ dày	Trọng lượng
DYT10016070	YE-100	0.7 mm	0.23 kg/m	DYT10045060	NDAVE-100B	0.6 mm	0.196 kg/m	DYT10018070	YE-90	0.7 mm	0.26 kg/m
Mã mới	Mã cũ	Độ dày	Trọng lượng	Mã mới	Mã cũ	Độ dày	Trọng lượng	Mã mới	Mã cũ	Độ dày	Trọng lượng
DYT10030060	PS4332	0.6 mm	0.387 kg/m	DYT10032070	DN-4332A	0.7 mm	0.453 kg/m	DYT10063055	DY4332	0.55 mm	0.355 kg/m
Mã mới	Mã cũ	Độ dày	Trọng lượng	Mã mới	Mã cũ	Độ dày	Trọng lượng	Mã mới	Mã cũ	Độ dày	Trọng lượng

LIST MẶT CẮT HỆ DY - 700

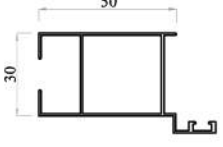
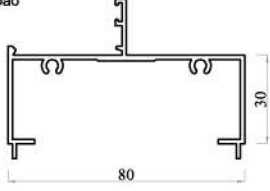
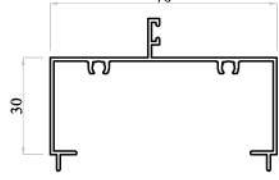
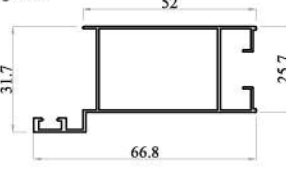
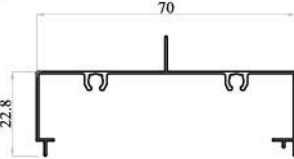
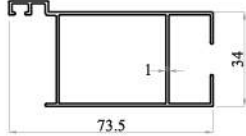
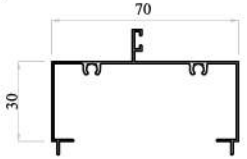
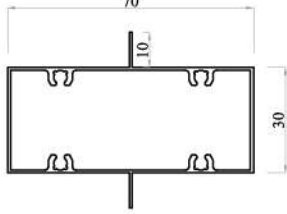
Đứng móc				Khung bao				Vách																
Mã mới	Mã cũ	Độ dày	Trọng lượng	Mã mới	Mã cũ	Độ dày	Trọng lượng	Mã mới	Mã cũ	Độ dày	Trọng lượng													
																								
DY700114115	DN-7053	1.15 mm	0.636 kg/m	DY380141140	7002VH	1.4 mm	0.828 kg/m	DY700311110	DA7001A	1.1 mm	0.568 kg/m													
DY700314110	DA7004A	1.1 mm	0.606 kg/m	<th colspan="4">Đứng móc</th> <td colspan="4">Vách</td>	Đứng móc				Vách															
DY700204080	DA7004	0.8 mm	0.453 kg/m																					
DY700104080	PS7053	0.8 mm	0.467 kg/m		<table border="1"> <thead> <tr> <th>Mã mới</th> <th>Mã cũ</th> <th>Độ dày</th> <th>Trọng lượng</th> <th>Mã mới</th> <th>Mã cũ</th> <th>Độ dày</th> <th>Trọng lượng</th> </tr> </thead> <tbody> <tr> <td>DY700019060</td> <td>DAB-11</td> <td>0.6 mm</td> <td>0.388 kg/m</td> <td>DY700301060</td> <td>DA7001B</td> <td>0.6 mm</td> <td>0.278 kg/m</td> </tr> </tbody> </table>				Mã mới	Mã cũ	Độ dày	Trọng lượng	Mã mới	Mã cũ	Độ dày	Trọng lượng	DY700019060	DAB-11	0.6 mm	0.388 kg/m	DY700301060	DA7001B	0.6 mm	0.278 kg/m
Mã mới	Mã cũ	Độ dày	Trọng lượng		Mã mới	Mã cũ	Độ dày	Trọng lượng																
DY700019060	DAB-11	0.6 mm	0.388 kg/m		DY700301060	DA7001B	0.6 mm	0.278 kg/m																
DY700304070	DA7004B	0.7 mm	0.415 kg/m		<th colspan="4">Đứng móc</th> <td colspan="4">Vách</td>				Đứng móc				Vách											
DY700605070	DY7053	0.7 mm	0.417 kg/m																					
<th colspan="4">Đố T</th> <td colspan="4"></td>				Đố T																				
																								
Mã mới	Mã cũ	Độ dày	Trọng lượng	Mã mới	Mã cũ	Độ dày	Trọng lượng	Mã mới	Mã cũ	Độ dày	Trọng lượng													
DY700102080	DSY-7005	0.8 mm	0.646 kg/m	DY710004100	DY-70104	1.0 mm	0.635 kg/m	DY7000201080	DA7001	0.8	0.435 kg/m													
DY700609070	DY7005	0.7mm	0.562 kg/m																					

HỆ CỬA ĐI MỞ TRƯỢT DY - 760

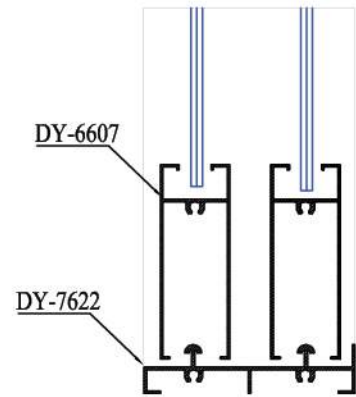
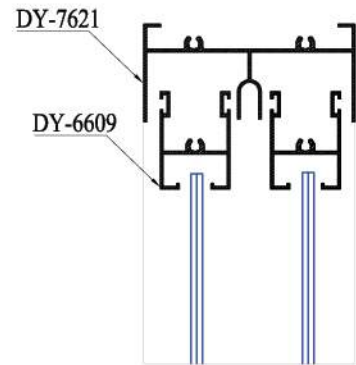
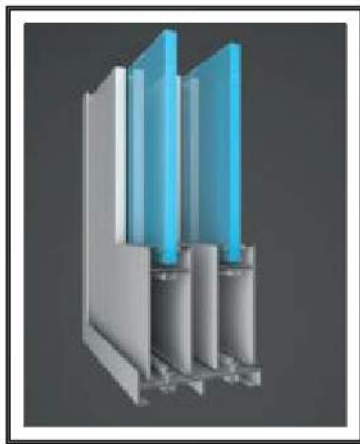
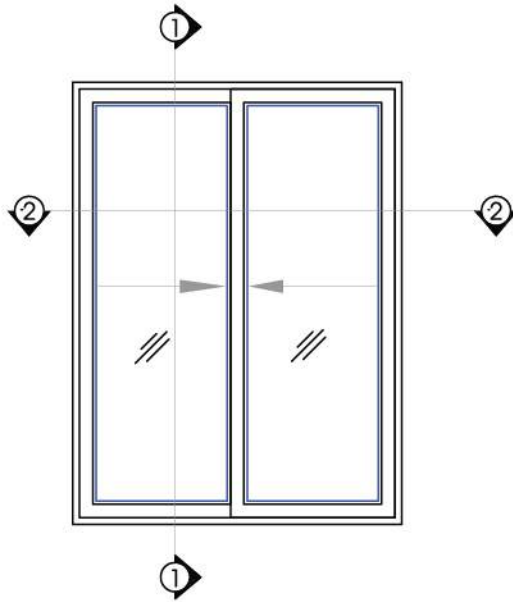

BÊN NGOÀI

BÊN TRONG

MẶT CẮT 1-1

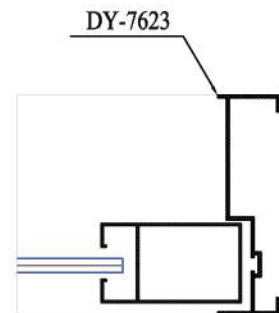
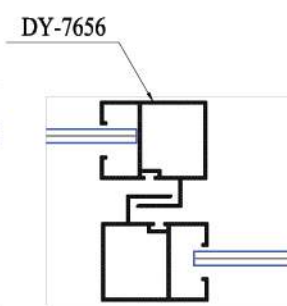
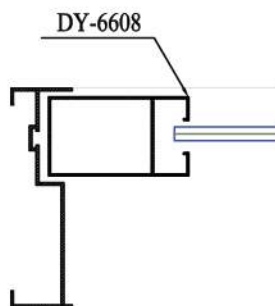

BÊN TRONG

BÊN NGOÀI

MẶT CẮT 2-2

LIST MẶT CẮT HỆ DY - 760

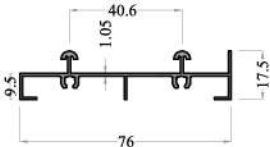
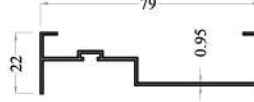
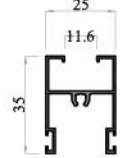
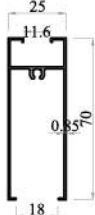
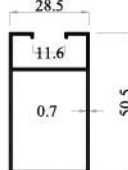
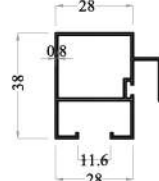
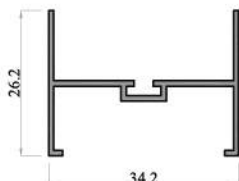
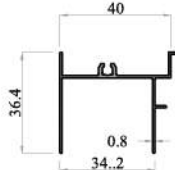
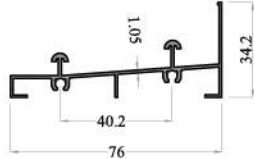
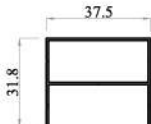
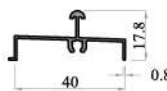
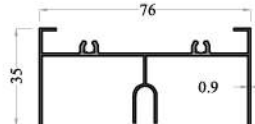
<p>Ray dưới</p> 				<p>Đứng khung bao</p> 				<p>Ngang cánh trên</p> 			
Mã mới	Mã cũ	Độ dày	Trọng lượng	Mã mới	Mã cũ	Độ dày	Trọng lượng	Mã mới	Mã cũ	Độ dày	Trọng lượng
DY760002105	DY-7622	1.05 mm	0.488 kg/m	DY760003095	PS7623	0.95 mm	0.369 kg/m	DY760004085	PS6609	0.85 mm	0.317 kg/m
<p>Ngang cánh dưới</p> 				<p>Đứng tron</p> 				<p>Đứng móc</p> 			
Mã mới	Mã cũ	Độ dày	Trọng lượng	Mã mới	Mã cũ	Độ dày	Trọng lượng	Mã mới	Mã cũ	Độ dày	Trọng lượng
DY760005085	PS6607	0.85 mm	0.458 kg/m	DY760006070	PS6608	0.7 mm	0.332 kg/m	DY760007080	PS7656	0.8 mm	0.389 kg/m
								<p>Ray dưới</p> 			
Mã mới	Mã cũ	Độ dày	Trọng lượng	Mã mới	Mã cũ	Độ dày	Trọng lượng	Mã mới	Mã cũ	Độ dày	Trọng lượng
DY760008100	PS7626	1 mm	0.246 kg/m	DY760011080	PS6606	0.8 mm	0.299 kg/m	DY760012105	PS7622A	1.05 mm	0.53 kg/m
								<p>Ray trên</p> 			
Mã mới	Mã cũ	Độ dày	Trọng lượng	Mã mới	Mã cũ	Độ dày	Trọng lượng	Mã mới	Mã cũ	Độ dày	Trọng lượng
DY760013080	PS6604	0.8 mm	0.301 kg/m	DY760022080	PS6605	0.8 mm	0.214 kg/m	DY760001090	PS7621	0.9 mm	0.554 kg/m
Mã mới	Mã cũ	Độ dày	Trọng lượng	Mã mới	Mã cũ	Độ dày	Trọng lượng	Mã mới	Mã cũ	Độ dày	Trọng lượng
.	.	. mm	. kg/m	.	.	. mm	. kg/m	.	.	. mm	. kg/m

HỆ CỬA ĐI MỞ TRƯỢT DY - 1000

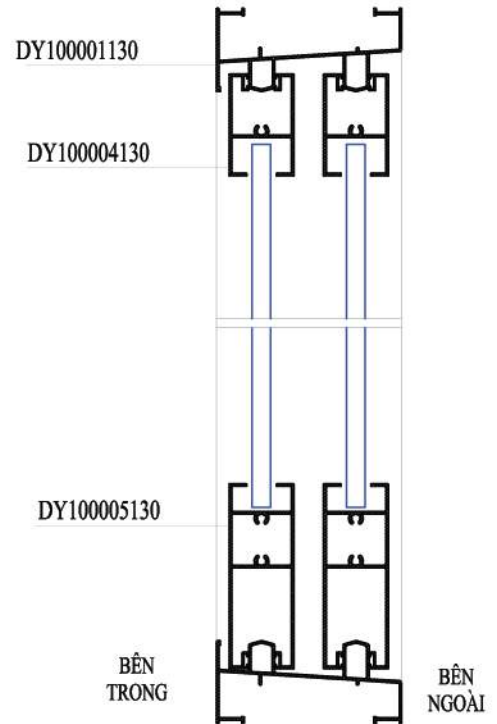
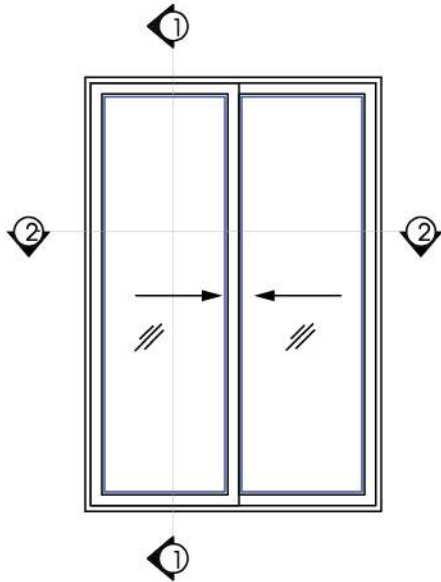

MẶT CẮT 1-1

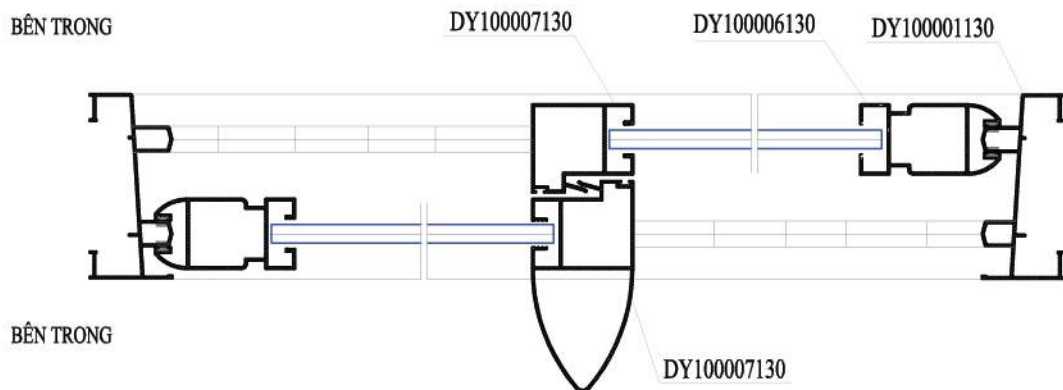

MẶT CẮT 2-2

LIST MẶT CẮT CỬA TRƯỢT HỆ DY - 1000

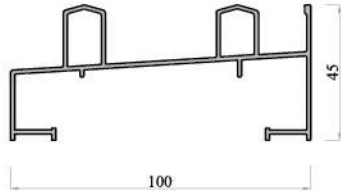
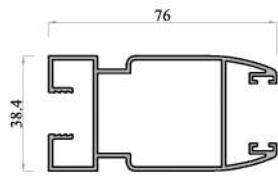
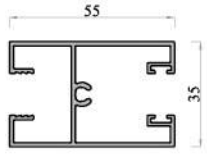
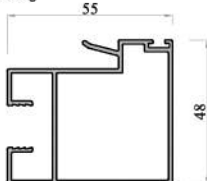
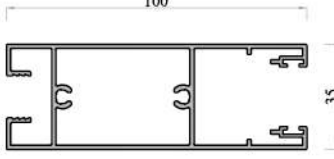
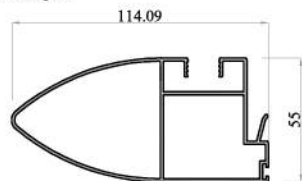
<p>Ray lùa</p> 				<p>Đứng trơn</p> 				<p>Ngang cánh trên</p> 			
Mã mới	Mã cũ	Độ dày	Trọng lượng	Mã mới	Mã cũ	Độ dày	Trọng lượng	Mã mới	Mã cũ	Độ dày	Trọng lượng
DY100001130		1.3 mm	1.058 kg/m	DY100006130		1.3 mm	1.030 kg/m	DY100004130		1.3 mm	0.794 kg/m
<p>Đứng móc trong</p> 				<p>Ngang cánh dưới</p> 				<p>Đứng móc ngoài</p> 			
Mã mới	Mã cũ	Độ dày	Trọng lượng	Mã mới	Mã cũ	Độ dày	Trọng lượng	Mã mới	Mã cũ	Độ dày	Trọng lượng
DY100007130		1.3 mm	0.894 kg/m	DY100005130		1.3 mm	1.289 kg/m	DY100017130		1.3 mm	1.411 kg/m
Mã mới	Mã cũ	Độ dày	Trọng lượng	Mã mới	Mã cũ	Độ dày	Trọng lượng	Mã mới	Mã cũ	Độ dày	Trọng lượng
Mã mới	Mã cũ	Độ dày	Trọng lượng	Mã mới	Mã cũ	Độ dày	Trọng lượng	Mã mới	Mã cũ	Độ dày	Trọng lượng
Mã mới	Mã cũ	Độ dày	Trọng lượng	Mã mới	Mã cũ	Độ dày	Trọng lượng	Mã mới	Mã cũ	Độ dày	Trọng lượng

HỆ CỬA ĐI MỞ QUAY DY - 1000

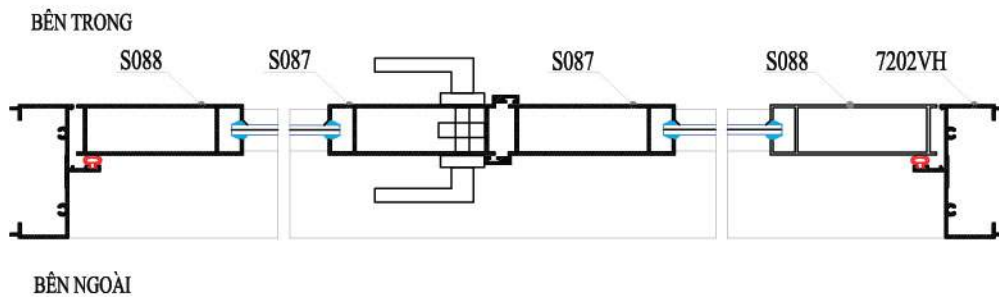
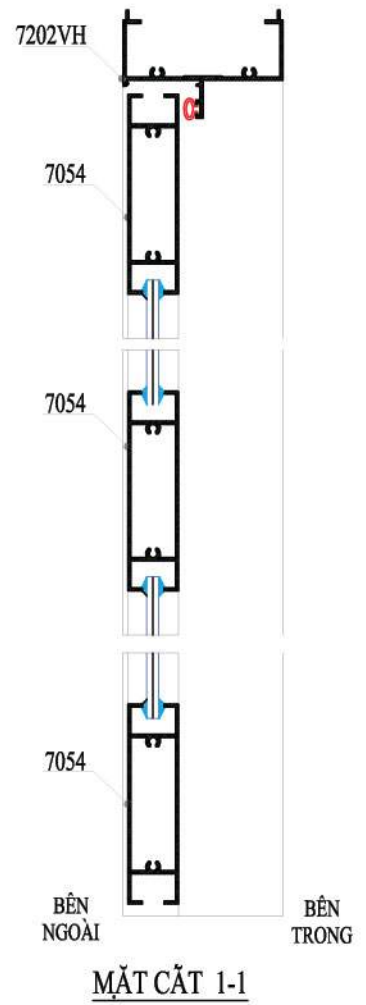
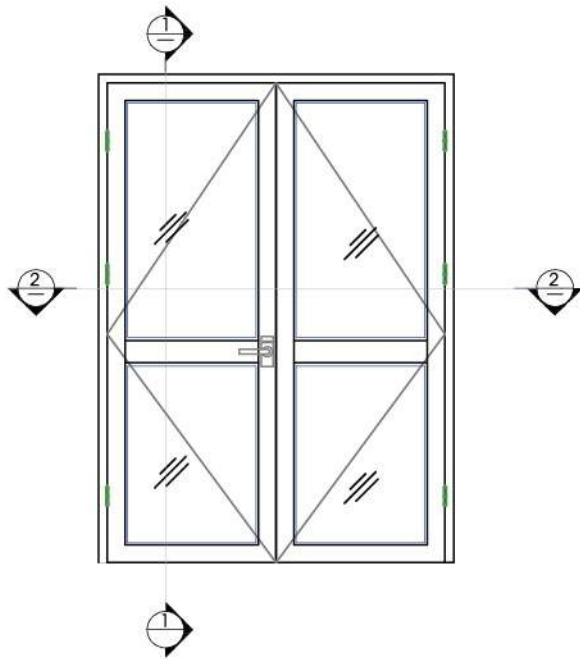

LIST MẶT CẮT CỬA MỞ QUAY HỆ DY - 1000

Mã mới				Mã cũ				Độ dày				Trọng lượng			
DY700312110				DA7002A				1.1 mm				0.526 kg/m			
DY700121100				DN-7002				1.0 mm				0.501 kg/m			
DY700101080				PS7002				0.8 mm				0.448 kg/m			
DY700202080				DA7002				0.8 mm				0.426 kg/m			
DY700302060				DA7002B				0.6 mm				0.375 kg/m			
DY700601070				DY7002				0.7 mm				0.42 kg/m			
DY700116120				DN-7054				1.2 mm				0.956 kg/m			
DY700316110				DA7006A				1.1 mm				0.878 kg/m			
DY700106080				PS7054				0.8 mm				0.671 kg/m			
DY700606070				DY7054				0.7 mm				0.603 kg/m			
DY700306070				DA7006B				0.7 mm				0.58 kg/m			
DYT10025120				S087				1.2 mm				1.046 kg/m			
DY100104110				PS087				1.1 mm				0.92 kg/m			
DYG18602120M				THC-S087M				1.2 mm				1.051 kg/m			
DY700680110				4509				1.1 mm				0.715 kg/m			
DYT10067055				DY6002				0.55				0.052 kg/m			
DYT10033065				SY-6002				0.65 mm				0.061 kg/m			
DYT10059070				DY9842				0.7				0.066 kg/m			
DYT10028065				SY-9842				0.65				0.07 kg/m			

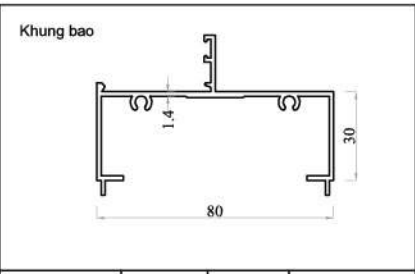
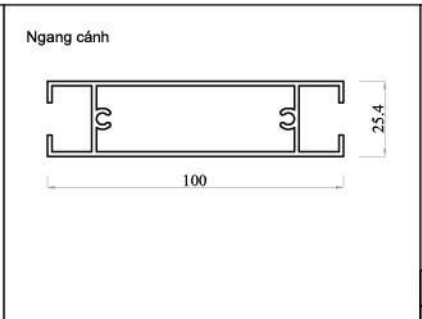
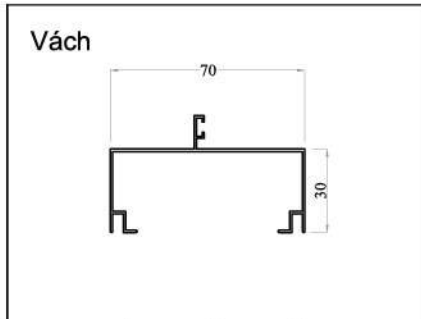

Mã mới	Mã cũ	Độ dày	Trọng lượng
DY700312110	DA7002A	1.1 mm	0.526 kg/m
DY700121100	DN-7002	1.0 mm	0.501 kg/m
DY700101080	PS7002	0.8 mm	0.448 kg/m
DY700202080	DA7002	0.8 mm	0.426 kg/m
DY700302060	DA7002B	0.6 mm	0.375 kg/m
DY700601070	DY7002	0.7 mm	0.42 kg/m

Mã mới	Mã cũ	Độ dày	Trọng lượng
DY700116120	DN-7054	1.2 mm	0.956 kg/m
DY700316110	DA7006A	1.1 mm	0.878 kg/m
DY700106080	PS7054	0.8 mm	0.671 kg/m
DY700606070	DY7054	0.7 mm	0.603 kg/m
DY700306070	DA7006B	0.7 mm	0.58 kg/m

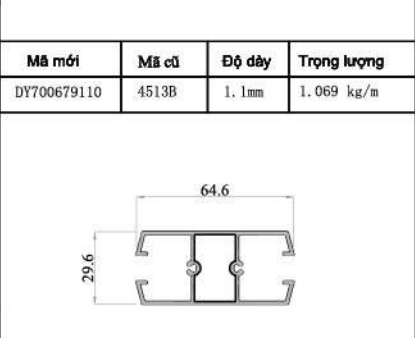
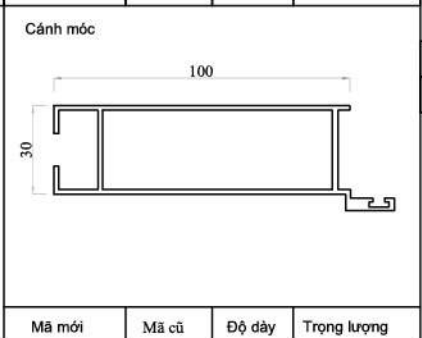
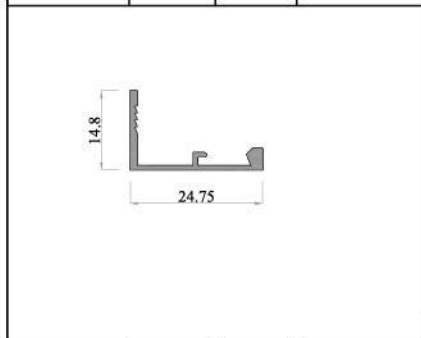
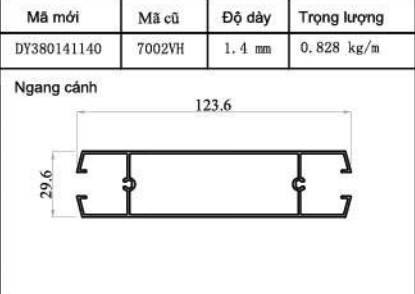

Mã mới	Mã cũ	Độ dày	Trọng lượng
DYT10027080	SY-9841	0.8mm	0.12 kg/m
DYT10058070	DY9841	0.7 mm	0.105 kg/m

Mã mới	Mã cũ	Độ dày	Trọng lượng
DYT10025120	S087	1.2 mm	1.046 kg/m
DY100104110	PS087	1.1 mm	0.92 kg/m
DYG18602120M	THC-S087M	1.2 mm	1.051 kg/m

Mã mới	Mã cũ	Độ dày	Trọng lượng
DY700680110	4509	1.1 mm	0.715 kg/m

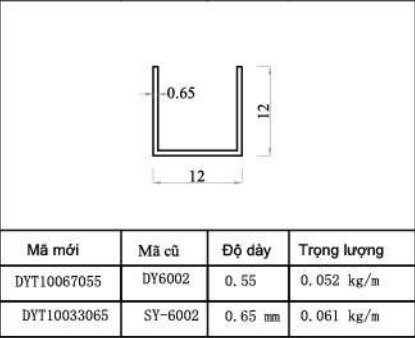
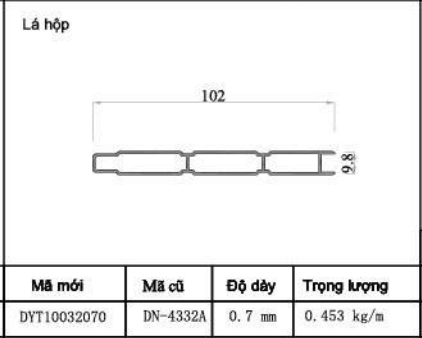
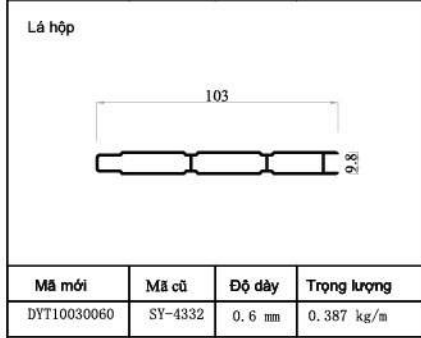

Mã mới	Mã cũ	Độ dày	Trọng lượng
DYT10030060	SY-4332	0.6 mm	0.387 kg/m

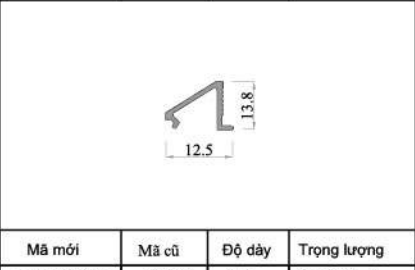
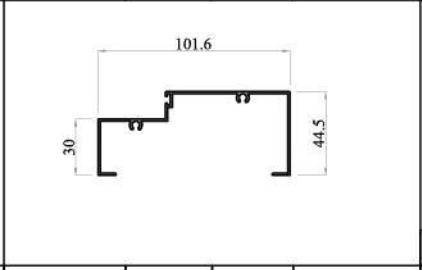

Mã mới	Mã cũ	Độ dày	Trọng lượng
DYT10022070	DK-010	0.7 mm	0.076 kg/m

Mã mới	Mã cũ	Độ dày	Trọng lượng
DYT10020120	DK-008	1.2 mm	0.758 kg/m

Mã mới	Mã cũ	Độ dày	Trọng lượng
DYT10059070	DY9842	0.7	0.066 kg/m
DYT10028065	SY-9842	0.65	0.07 kg/m

LIST MẶT CẮT CỬA MỞ QUAY HỆ DY - 1000

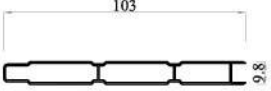
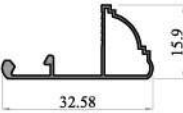
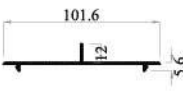
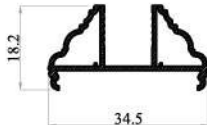
<p>Lá hộp</p> 											
Mã mới	Mã cũ	Độ dày	Trọng lượng	Mã mới	Mã cũ	Độ dày	Trọng lượng	Mã mới	Mã cũ	Độ dày	Trọng lượng
DYT10063055	DY4332	0.55 mm	0.355 kg/m	DYT10021060	DK-009	0.6 mm	0.154 kg/m	DYT10023120	DK-052	1.2 mm	0.402 kg/m
											
Mã mới	Mã cũ	Độ dày	Trọng lượng	Mã mới	Mã cũ	Độ dày	Trọng lượng	Mã mới	Mã cũ	Độ dày	Trọng lượng
DYT10024080	DK-077	0.8 mm	0.24 kg/m								
Mã mới	Mã cũ	Độ dày	Trọng lượng	Mã mới	Mã cũ	Độ dày	Trọng lượng	Mã mới	Mã cũ	Độ dày	Trọng lượng
Mã mới	Mã cũ	Độ dày	Trọng lượng	Mã mới	Mã cũ	Độ dày	Trọng lượng	Mã mới	Mã cũ	Độ dày	Trọng lượng
Mã mới	Mã cũ	Độ dày	Trọng lượng	Mã mới	Mã cũ	Độ dày	Trọng lượng	Mã mới	Mã cũ	Độ dày	Trọng lượng

HỆ CỬA ĐI MỞ QUAY DY - 1400

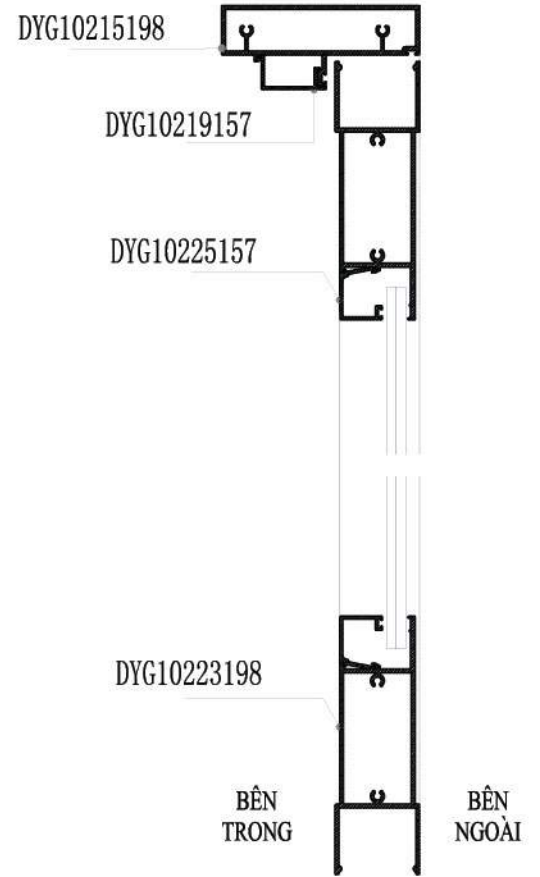
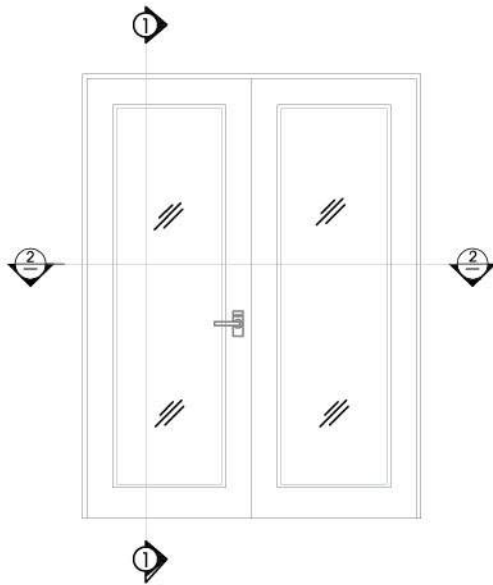

MẶT CẮT 1-1

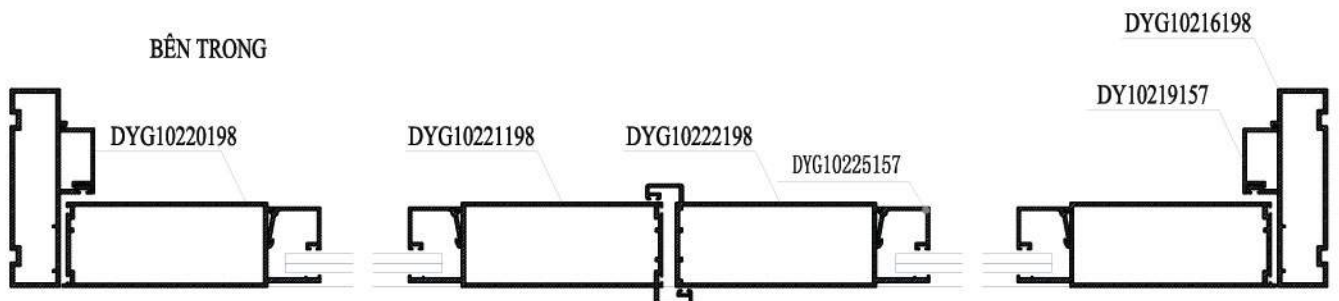

MẶT CẮT 2-2

LIST MẶT CẮT HỆ DY - 1400

Mã mới	Mã cũ	Độ dày	Trọng lượng	Mã mới	Mã cũ	Độ dày	Trọng lượng	Mã mới	Mã cũ	Độ dày	Trọng lượng
DYG10215198	1202001	1.98 mm	1.62 kg/m	DYG10222198	1202008	1.98 mm	2.061 kg/m	DYG10216198	1202002	1.98 mm	1.53 kg/m
Mã mới	Mã cũ	Độ dày	Trọng lượng	Mã mới	Mã cũ	Độ dày	Trọng lượng	Mã mới	Mã cũ	Độ dày	Trọng lượng
DYG10223198	1202009	1.98 mm	2.001 kg/m	DYG10220198	1202006	1.98 mm	1.887 kg/m	DYG10225157	1202011	1.57 mm	0.322 kg/m
Mã mới	Mã cũ	Độ dày	Trọng lượng	Mã mới	Mã cũ	Độ dày	Trọng lượng	Mã mới	Mã cũ	Độ dày	Trọng lượng
DYG10221198	1202007	1.98 mm	2.071 kg/m	DYG10219157	1202005	1.57 mm	0.255 kg/m	DYG10227635	1202013	6.35 mm	2.098 kg/m
Mã mới	Mã cũ	Độ dày	Trọng lượng	Mã mới	Mã cũ	Độ dày	Trọng lượng	Mã mới	Mã cũ	Độ dày	Trọng lượng
DYG10217198	1202003	1.98 mm	1.33 kg/m	DYG10218198	1202004	1.98 mm	1.169 kg/m	DYG10224158	1202010	1.58 mm	0.323 kg/m
Mã mới	Mã cũ	Độ dày	Trọng lượng	Mã mới	Mã cũ	Độ dày	Trọng lượng	Mã mới	Mã cũ	Độ dày	Trọng lượng
DYG10226157	1202012	1.57 mm	0.525 kg/m								

HỆ CỬA ĐI MỞ QUAY DY - 5001

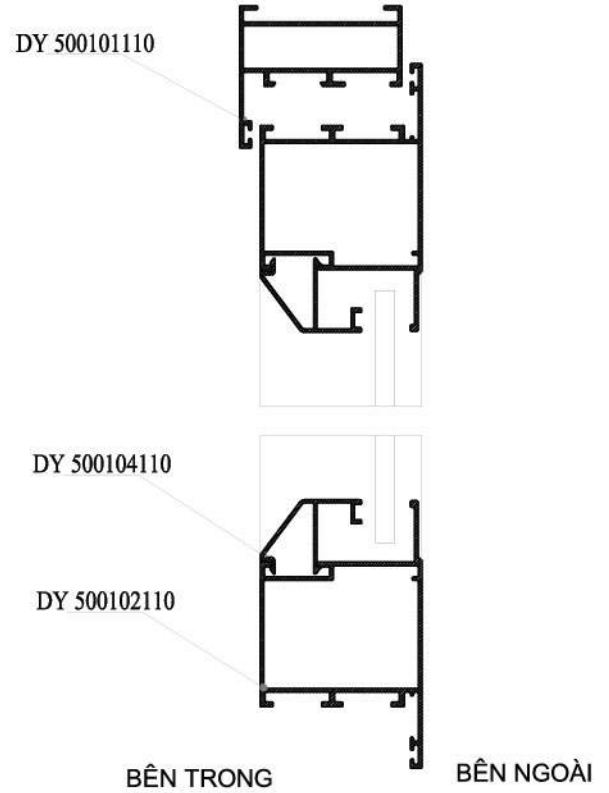
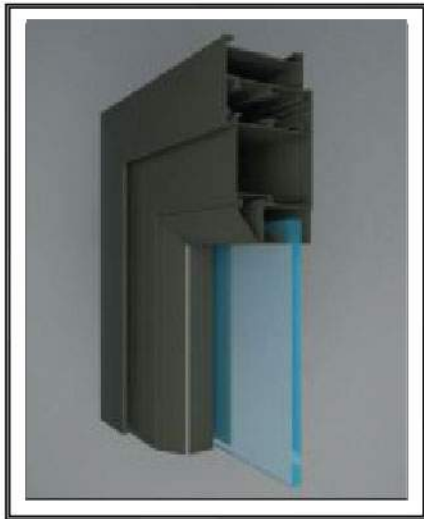
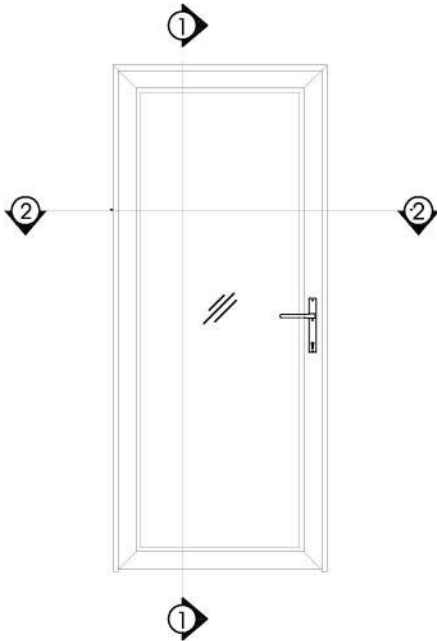

MẶT CẮT 1-1

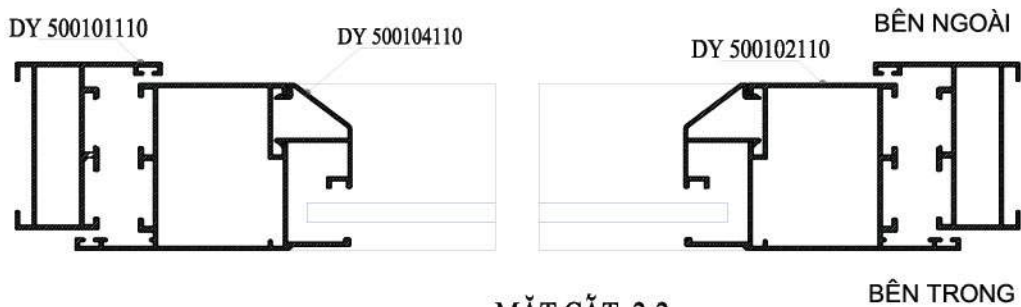

MẶT CẮT 2-2

LIST MẶT CẮT HỆ DY - 5001

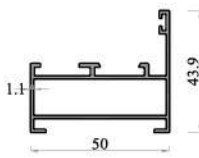
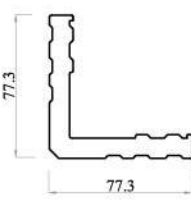
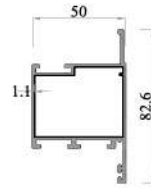
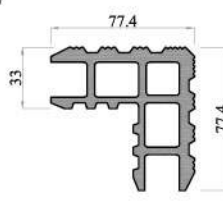
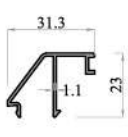
<p>Khung bao</p> 				<p>Ke khung</p> 				<p>Cánh</p> 			
Mã mới	Mã cũ	Độ dày	Trọng lượng	Mã mới	Mã cũ	Độ dày	Trọng lượng	Mã mới	Mã cũ	Độ dày	Trọng lượng
DY500101110		1.1 mm	1.620 kg/m	DY500106000			4.177 kg/m	DY500102110		1.1 mm	0.831 kg/m
<p>Ke cánh</p> 				<p>Sập</p> 							
Mã mới	Mã cũ	Độ dày	Trọng lượng	Mã mới	Mã cũ	Độ dày	Trọng lượng	Mã mới	Mã cũ	Độ dày	Trọng lượng
DY500116000			4.529 kg/m	DY500104110		1.1 mm	0.222 kg/m				
Mã mới	Mã cũ	Độ dày	Trọng lượng	Mã mới	Mã cũ	Độ dày	Trọng lượng	Mã mới	Mã cũ	Độ dày	Trọng lượng
Mã mới	Mã cũ	Độ dày	Trọng lượng	Mã mới	Mã cũ	Độ dày	Trọng lượng	Mã mới	Mã cũ	Độ dày	Trọng lượng
Mã mới	Mã cũ	Độ dày	Trọng lượng	Mã mới	Mã cũ	Độ dày	Trọng lượng	Mã mới	Mã cũ	Độ dày	Trọng lượng

HỆ CỬA ĐI MỞ TRƯỢT DY - 9000

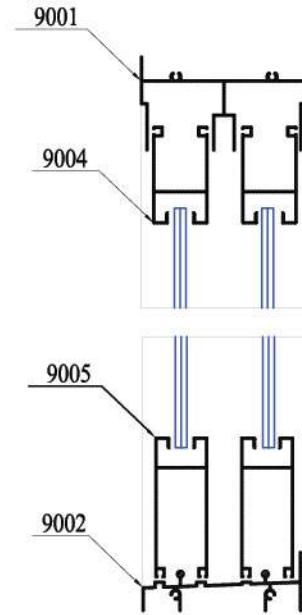
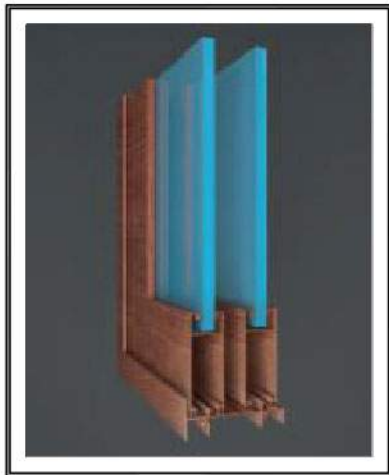
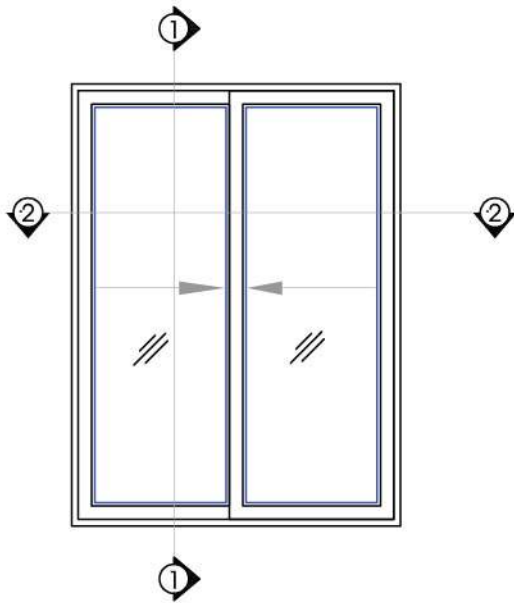

BÊN NGOÀI



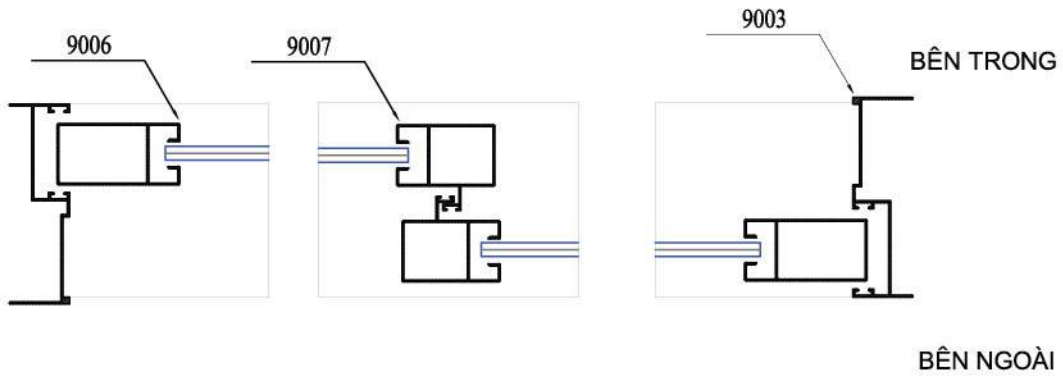

BÊN TRONG

MẶT CẮT 1-1

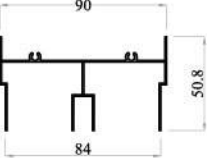

MẶT CẮT 2-2

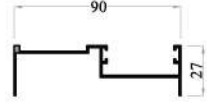
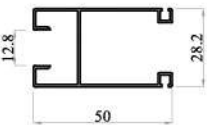
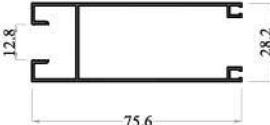
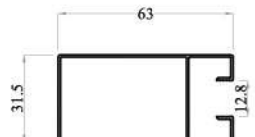
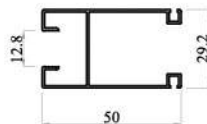
LIST MẶT CẮT HỆ DY - 9000

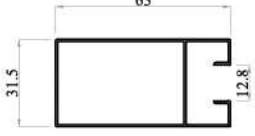
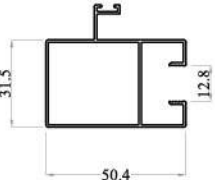
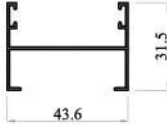
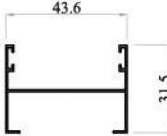
<p>Ray trên</p> 				<p>Ray dưới</p> 				<p>Đứng khung bao</p> 			
Mã mới	Mã cũ	Độ dày	Trọng lượng	Mã mới	Mã cũ	Độ dày	Trọng lượng	Mã mới	Mã cũ	Độ dày	Trọng lượng
DY900001090	9001	0.9 mm	0.71 kg/m	DY900002090	9002	0.9 mm	0.55 kg/m	DY900003090	9003	0.9 mm	0.45 kg/m
<p>Ngang cánh trên</p> 				<p>Ngang cánh dưới</p> 				<p>Đứng tron</p> 			
Mã mới	Mã cũ	Độ dày	Trọng lượng	Mã mới	Mã cũ	Độ dày	Trọng lượng	Mã mới	Mã cũ	Độ dày	Trọng lượng
DY900004085	9004	0.9 mm	0.39 kg/m	DY900005085	9005	0.85 mm	0.551 kg/m	DY900006085	9006	0.85 mm	0.493 kg/m
<p>Ngang cánh trên</p> 				<p>Ngang cánh dưới</p> 				<p>Đứng tron</p> 			
Mã mới	Mã cũ	Độ dày	Trọng lượng	Mã mới	Mã cũ	Độ dày	Trọng lượng	Mã mới	Mã cũ	Độ dày	Trọng lượng
DY900014060	9004B	0.6 mm	0.28 kg/m	DY900015060	9005B	0.6 mm	0.371 kg/m	DY900016075	9006B	0.75 mm	0.437 kg/m
<p>Đứng móc</p> 				<p>Nối</p> 							
Mã mới	Mã cũ	Độ dày	Trọng lượng	Mã mới	Mã cũ	Độ dày	Trọng lượng	Mã mới	Mã cũ	Độ dày	Trọng lượng
DY900007085	9007	0.85 mm	0.495 kg/m	DY900008090	9008	0.9 mm	0.313 kg/m				
				<p>Nối</p> 							
Mã mới	Mã cũ	Độ dày	Trọng lượng	Mã mới	Mã cũ	Độ dày	Trọng lượng	Mã mới	Mã cũ	Độ dày	Trọng lượng
				DY900018060	9008B	0.6 mm	0.227 kg/m				

HỆ CỬA ĐI MỞ TRƯỢT DY - 9001

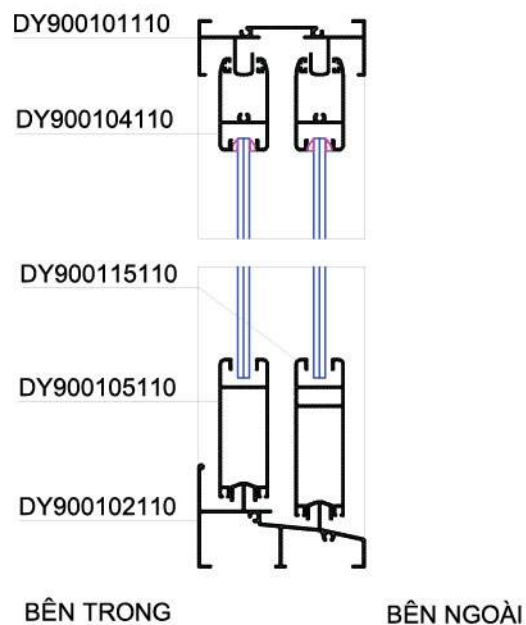
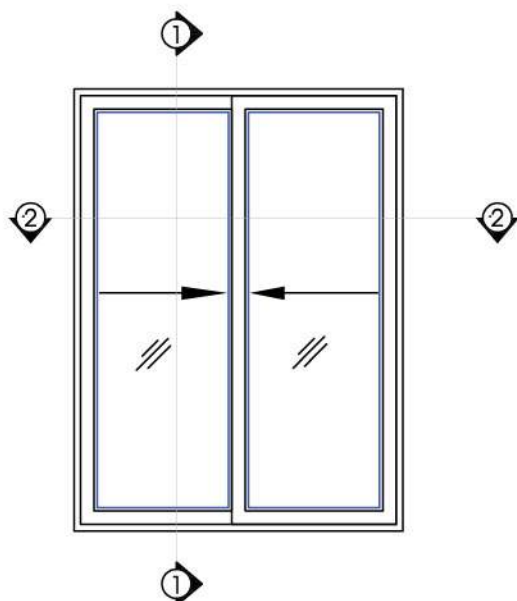

MẶT CẮT 1-1

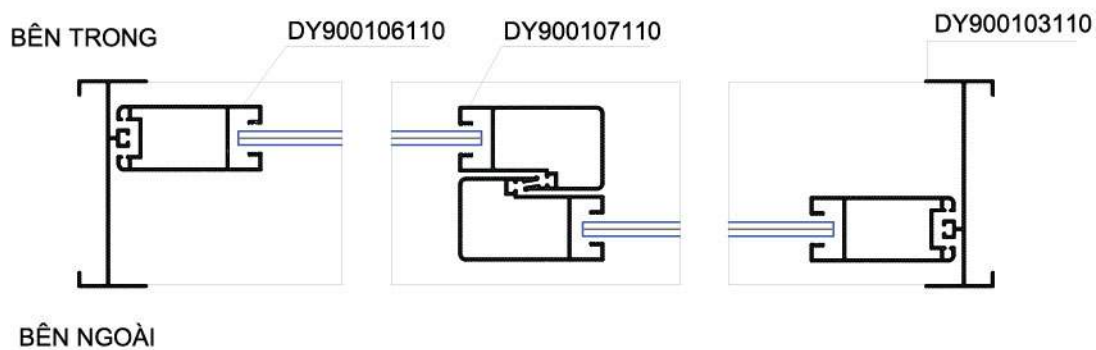

MẶT CẮT 2-2

LIST MẶT CẮT HỆ DY - 9001

Mã mới	Mã cũ	Độ dày	Trọng lượng	Mã mới	Mã cũ	Độ dày	Trọng lượng	Mã mới	Mã cũ	Độ dày	Trọng lượng
DY900101110		1.1 mm	0.832 kg/m	DY900104110		1.1 mm	0.537 kg/m	DY900102110		1.1 mm	0.983 kg/m
Mã mới	Mã cũ	Độ dày	Trọng lượng	Mã mới	Mã cũ	Độ dày	Trọng lượng	Mã mới	Mã cũ	Độ dày	Trọng lượng
DY900115110		1.1 mm	0.744 kg/m	DY900103110		1.1 mm	0.562 kg/m	DY900106110		1.1 mm	0.686 kg/m
Mã mới	Mã cũ	Độ dày	Trọng lượng	Mã mới	Mã cũ	Độ dày	Trọng lượng	Mã mới	Mã cũ	Độ dày	Trọng lượng
DY900105110		1.1 mm	0.611 kg/m	DY900115100	DY-90115	1.0 mm	0.583 kg/m	DY900104100	DY90104	1.0 mm	0.516 kg/m
Mã mới	Mã cũ	Độ dày	Trọng lượng	Mã mới	Mã cũ	Độ dày	Trọng lượng	Mã mới	Mã cũ	Độ dày	Trọng lượng
DY900102100	DY-90102	1.0 mm	0.622 kg/m	DY900103100	DY-90103	1.0 mm	0.417 kg/m	DY900106100	DY-90106	1.0 mm	0.579 kg/m
Mã mới	Mã cũ	Độ dày	Trọng lượng	Mã mới	Mã cũ	Độ dày	Trọng lượng	Mã mới	Mã cũ	Độ dày	Trọng lượng
DY900110070	DY-90110	0.7 mm	0.087 kg/m	DY900111100	DY-90111	1.0 mm	0.631 kg/m	DY900118120	DY-90118	1.2 mm	0.17 kg/m

LIST MẶT CẮT HỆ DY - 9001

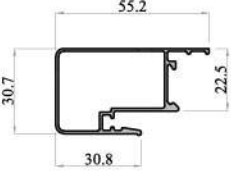
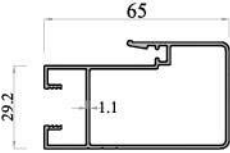
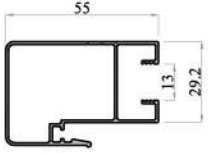
											
Mã mới	Mã cũ	Độ dày	Trọng lượng	Mã mới	Mã cũ	Độ dày	Trọng lượng	Mã mới	Mã cũ	Độ dày	Trọng lượng
DY900107100		1.0 mm	0.524 kg/m	DY900107110		1.1 mm	0.724 kg/m	DY900117100	DY-90107	1.0 mm	0.617 kg/m
Mã mới	Mã cũ	Độ dày	Trọng lượng	Mã mới	Mã cũ	Độ dày	Trọng lượng	Mã mới	Mã cũ	Độ dày	Trọng lượng
Mã mới	Mã cũ	Độ dày	Trọng lượng	Mã mới	Mã cũ	Độ dày	Trọng lượng	Mã mới	Mã cũ	Độ dày	Trọng lượng
Mã mới	Mã cũ	Độ dày	Trọng lượng	Mã mới	Mã cũ	Độ dày	Trọng lượng	Mã mới	Mã cũ	Độ dày	Trọng lượng
Mã mới	Mã cũ	Độ dày	Trọng lượng	Mã mới	Mã cũ	Độ dày	Trọng lượng	Mã mới	Mã cũ	Độ dày	Trọng lượng

CỬA ĐI MỞ TRƯỢT 3 CẢNH HỆ DY - 870

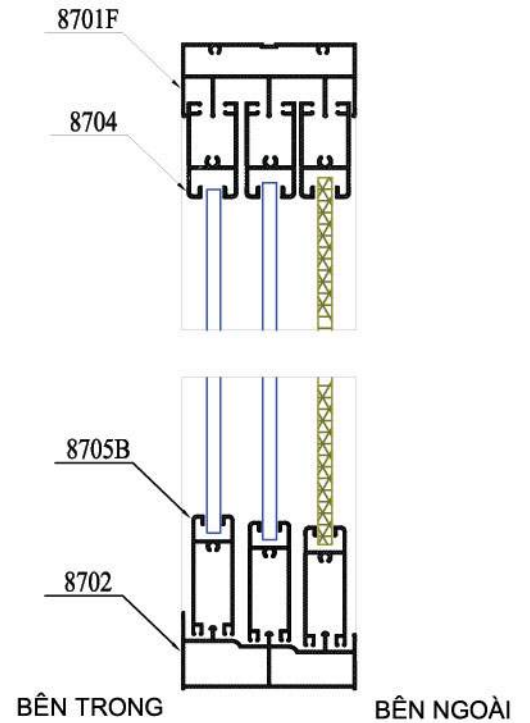
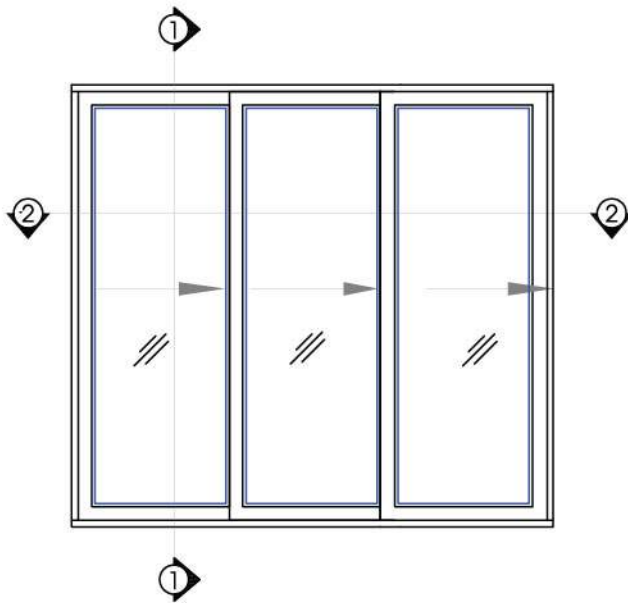

MẶT CẮT 1-1

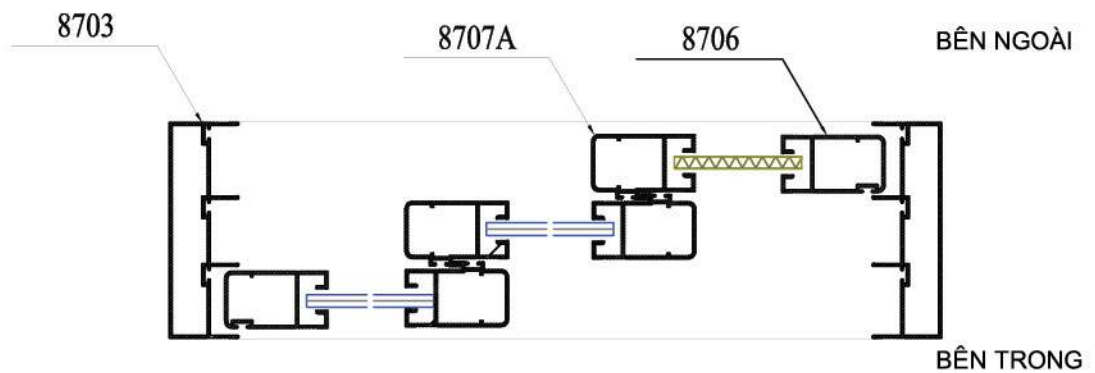

MẶT CẮT 2-2

LIST MẶT CẮT HỆ DY - 870

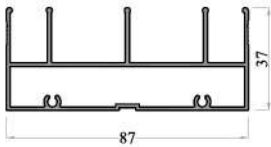
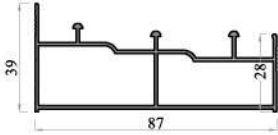
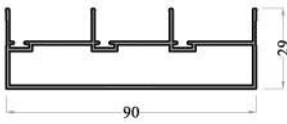
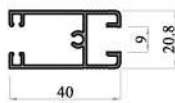
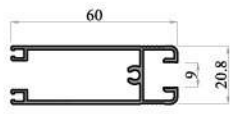
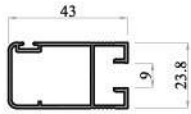
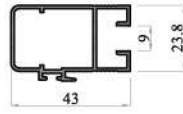
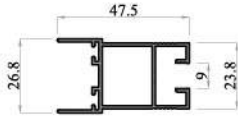
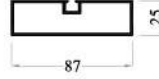
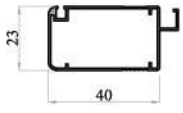
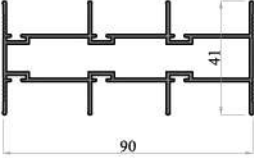
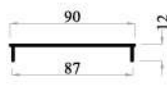
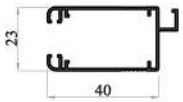
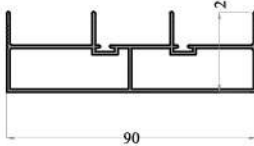
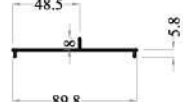
											
Mã mới	Mã cũ	Độ dày	Trọng lượng	Mã mới	Mã cũ	Độ dày	Trọng lượng	Mã mới	Mã cũ	Độ dày	Trọng lượng
DY870001120	8701F	1.2 mm	1.082 kg/m	DY870002120	8702	1.2 mm	0.927 kg/m	DY870003120	8703	1.2 mm	0.89 kg/m
											
Mã mới	Mã cũ	Độ dày	Trọng lượng	Mã mới	Mã cũ	Độ dày	Trọng lượng	Mã mới	Mã cũ	Độ dày	Trọng lượng
DY870004120	8704	1.2 mm	0.445 kg/m	DY870005120	8705B	1.2 mm	0.588 kg/m	DY870006120	8706	1.2 mm	0.49 kg/m
											
Mã mới	Mã cũ	Độ dày	Trọng lượng	Mã mới	Mã cũ	Độ dày	Trọng lượng	Mã mới	Mã cũ	Độ dày	Trọng lượng
DY870007120	8707A	1.2 mm	0.511 kg/m	DY870008120	8708	1.2 mm	0.556 kg/m	DY870009120	8711A	1.2 mm	0.768 kg/m
											
Mã mới	Mã cũ	Độ dày	Trọng lượng	Mã mới	Mã cũ	Độ dày	Trọng lượng	Mã mới	Mã cũ	Độ dày	Trọng lượng
DY870010080	8709	0.8 mm	0.32 kg/m	DY870013120	8703A	1.2 mm	1.11 kg/m	DY870019120	8712	1.2 mm	0.361 kg/m
											
Mã mới	Mã cũ	Độ dày	Trọng lượng	Mã mới	Mã cũ	Độ dày	Trọng lượng	Mã mới	Mã cũ	Độ dày	Trọng lượng
DY870020120	8709A	1.2 mm	0.311 kg/m	DY870023120	8703W	1.2 mm	0.92 kg/m	DY870029120	8713A	1.2 mm	0.345 kg/m

LIST MẶT CẮT HỆ DY - 870

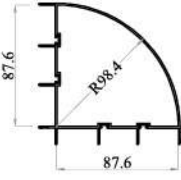
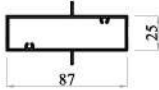
											
Mã mới	Mã cũ	Độ dày	Trọng lượng	Mã mới	Mã cũ	Độ dày	Trọng lượng	Mã mới	Mã cũ	Độ dày	Trọng lượng
DY870030120	8710	1.2 mm	1.41 kg/m	DY870039120	8718B	1.2 mm	0.826 kg/m				
Mã mới	Mã cũ	Độ dày	Trọng lượng	Mã mới	Mã cũ	Độ dày	Trọng lượng	Mã mới	Mã cũ	Độ dày	Trọng lượng
Mã mới	Mã cũ	Độ dày	Trọng lượng	Mã mới	Mã cũ	Độ dày	Trọng lượng	Mã mới	Mã cũ	Độ dày	Trọng lượng
Mã mới	Mã cũ	Độ dày	Trọng lượng	Mã mới	Mã cũ	Độ dày	Trọng lượng	Mã mới	Mã cũ	Độ dày	Trọng lượng
Mã mới	Mã cũ	Độ dày	Trọng lượng	Mã mới	Mã cũ	Độ dày	Trọng lượng	Mã mới	Mã cũ	Độ dày	Trọng lượng

HỆ CỬA ĐI MỞ TRƯỢT 4 CẢNH DY - 901

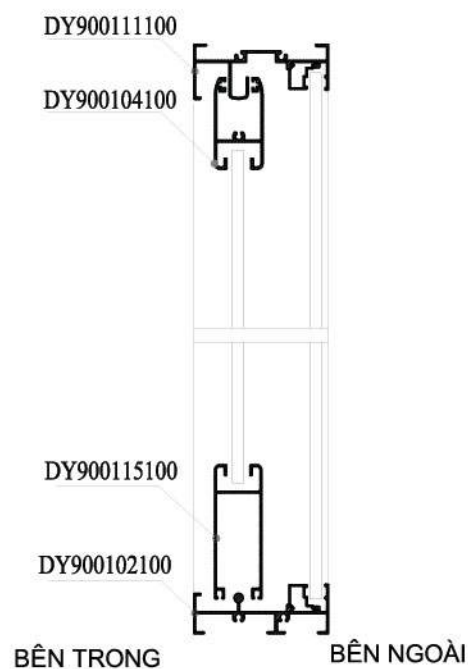
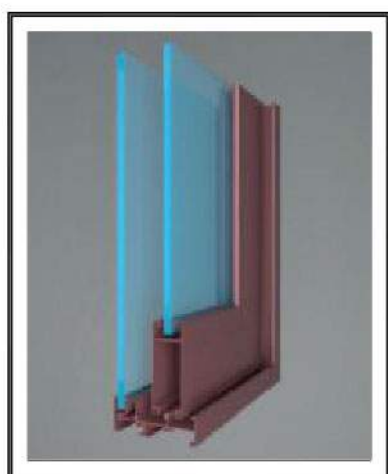
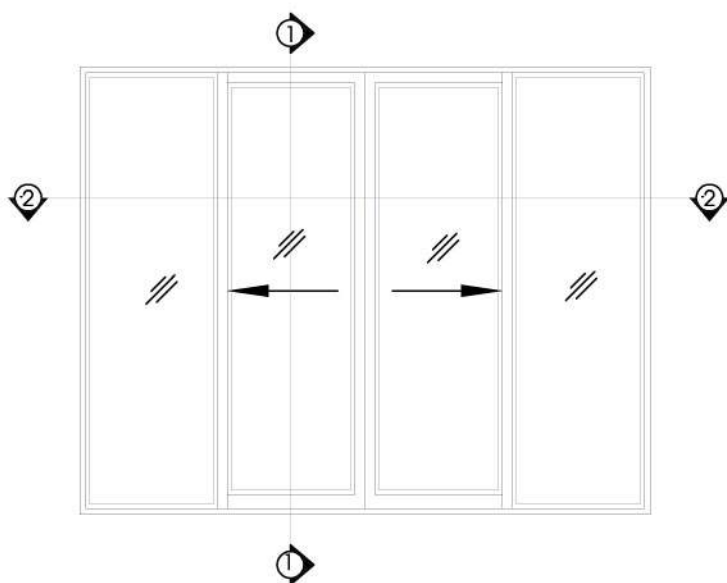

MẶT CẮT 1-1

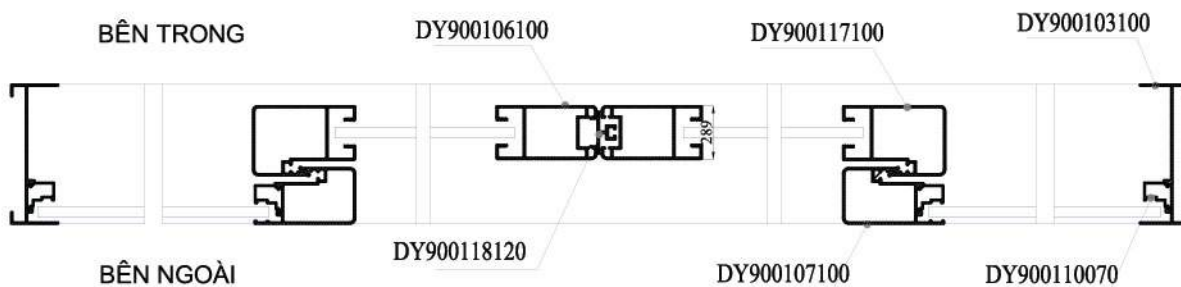

MẶT CẮT 2-2

LIST MẶT CẮT HỆ DY - 901

Mã mới	Mã cũ	Độ dày	Trọng lượng	Mã mới	Mã cũ	Độ dày	Trọng lượng	Mã mới	Mã cũ	Độ dày	Trọng lượng
DY900102100	DY-90102	1 mm	0.622 kg/m	DY900117100	DY-90107	1.0 mm	0.617 kg/m	DY900103100	DY-90103	1 mm	0.417 kg/m
Mã mới	Mã cũ	Độ dày	Trọng lượng	Mã mới	Mã cũ	Độ dày	Trọng lượng	Mã mới	Mã cũ	Độ dày	Trọng lượng
DY900107100		1.0 mm	0.524 kg/m	DY900104100	DY-90104	1.0 mm	0.516 kg/m	DY900110070	DY-90110	0.7 mm	0.087 kg/m
Mã mới	Mã cũ	Độ dày	Trọng lượng	Mã mới	Mã cũ	Độ dày	Trọng lượng	Mã mới	Mã cũ	Độ dày	Trọng lượng
DY900106100	DY-90106	1 mm	0.579 kg/m	DY900118120	DY-90118	1.2 mm	0.17 kg/m	DY900111100	DY-90111	1 mm	0.631 kg/m
Mã mới	Mã cũ	Độ dày	Trọng lượng	Mã mới	Mã cũ	Độ dày	Trọng lượng	Mã mới	Mã cũ	Độ dày	Trọng lượng
DY900115100	DY-90115	1 mm	0.583 kg/m								
Mã mới	Mã cũ	Độ dày	Trọng lượng	Mã mới	Mã cũ	Độ dày	Trọng lượng	Mã mới	Mã cũ	Độ dày	Trọng lượng

HỆ CỬA ĐI XÉP TRƯỢT DY - 9400

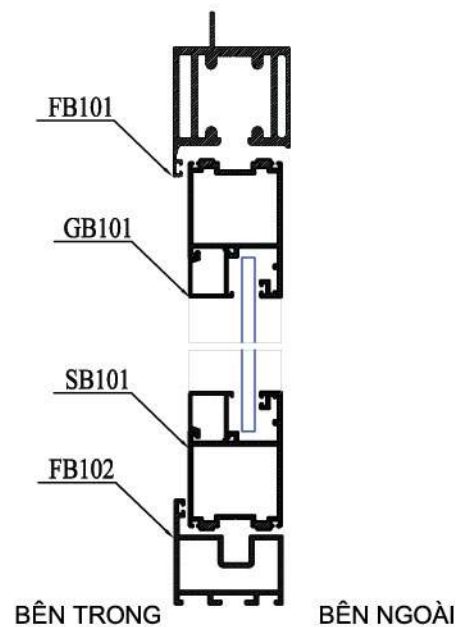

MẶT CẮT 1-1

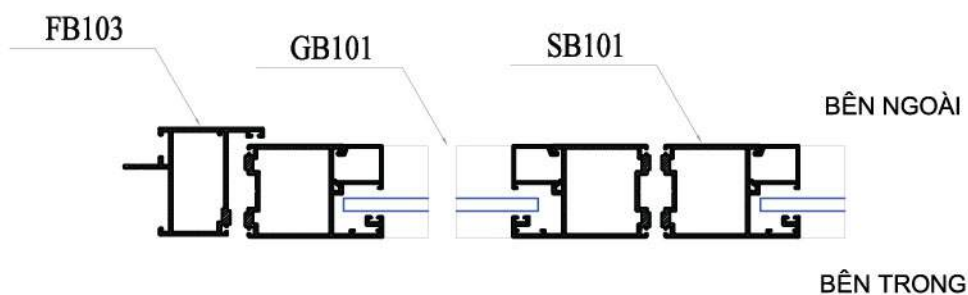
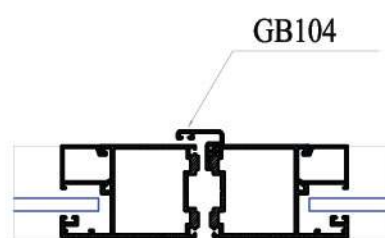
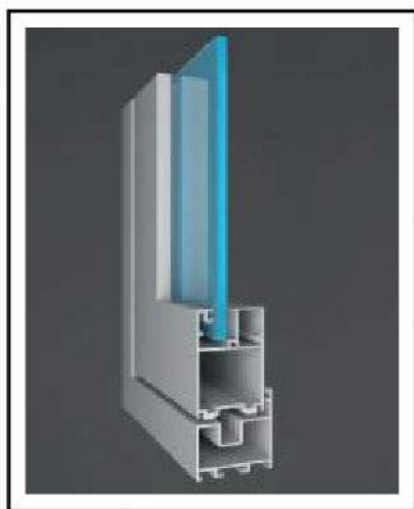

MẶT CẮT 2-2

LIST MẶT CẮT HỆ DY - 9400

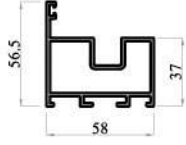
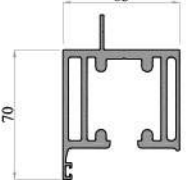
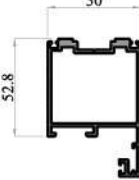
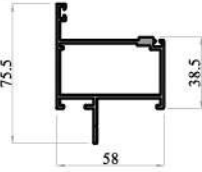
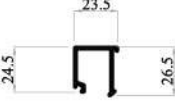
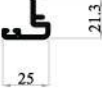
<p>Ray dưới</p> 				<p>Ray trên</p> 				<p>Cánh</p> 			
Mã mới	Mã cũ	Độ dày	Trọng lượng	Mã mới	Mã cũ	Độ dày	Trọng lượng	Mã mới	Mã cũ	Độ dày	Trọng lượng
DY940012180	FB102	1.8 mm	1.291 kg/m	DY940014000	FB101		3.244 kg/m	DY940015180	SB101	1.8 mm	1.422 kg/m
<p>Đứng khung bao</p> 				<p>Sập kính</p> 				<p>Hèm</p> 			
Mã mới	Mã cũ	Độ dày	Trọng lượng	Mã mới	Mã cũ	Độ dày	Trọng lượng	Mã mới	Mã cũ	Độ dày	Trọng lượng
DY940017180	FB103	1.8 mm	1.272 kg/m	DY940018120	GB101	1.2 mm	0.262 kg/m	DY940021130	GB104	1.3 mm	0.232 kg/m
Mã mới	Mã cũ	Độ dày	Trọng lượng	Mã mới	Mã cũ	Độ dày	Trọng lượng	Mã mới	Mã cũ	Độ dày	Trọng lượng
Mã mới	Mã cũ	Độ dày	Trọng lượng	Mã mới	Mã cũ	Độ dày	Trọng lượng	Mã mới	Mã cũ	Độ dày	Trọng lượng
Mã mới	Mã cũ	Độ dày	Trọng lượng	Mã mới	Mã cũ	Độ dày	Trọng lượng	Mã mới	Mã cũ	Độ dày	Trọng lượng

HỆ TỬ - VÁCH NGĂN

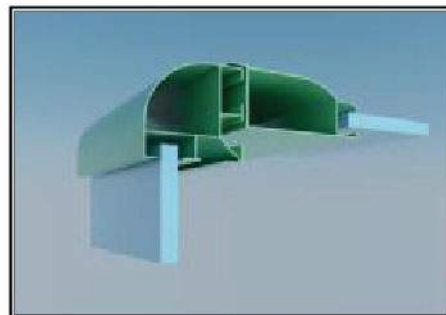

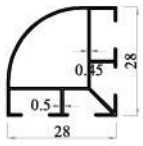
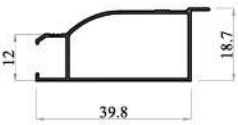
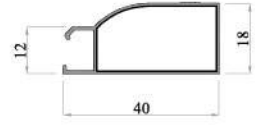
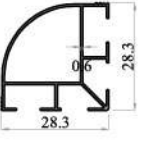
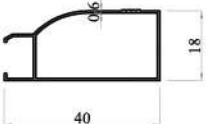
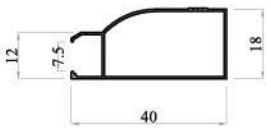
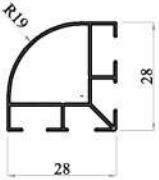
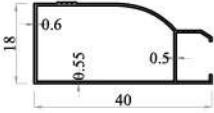
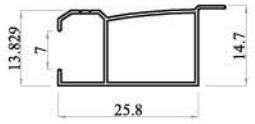
											
Mã mới	Mã cũ	Độ dày	Trọng lượng	Mã mới	Mã cũ	Độ dày	Trọng lượng	Mã mới	Mã cũ	Độ dày	Trọng lượng
DY200017050	PS9759	0.5 mm	0.174 kg/m	DY200002060	TL-15	0.6 mm	0.191 kg/m	DY200001060	TL-14	0.6 mm	0.184 kg/m
											
Mã mới	Mã cũ	Độ dày	Trọng lượng	Mã mới	Mã cũ	Độ dày	Trọng lượng	Mã mới	Mã cũ	Độ dày	Trọng lượng
DY200014060	TL-18B	0.6 mm	0.225 kg/m	DY200009060	NDATL-14B	0.6 mm	1.83 kg/m	DY200006060	TL-19	0.6 mm	0.18 kg/m
											
Mã mới	Mã cũ	Độ dày	Trọng lượng	Mã mới	Mã cũ	Độ dày	Trọng lượng	Mã mới	Mã cũ	Độ dày	Trọng lượng
DY200005060	TL-18	0.6 mm	0.22 kg/m	DY200018060	DY9761	0.6 mm	0.166 kg/m	DY200003060	TL-16	0.6 mm	0.141 kg/m

LIST MẶT CẮT HỆ TỬ - VÁCH NGĂN

Mã mới	Mã cũ	Độ dày	Trọng lượng	Mã mới	Mã cũ	Độ dày	Trọng lượng	Mã mới	Mã cũ	Độ dày	Trọng lượng
DY200010060	NDATL-18C	0.6 mm	0.226 kg/m	DY200021060	DY9764	0.6 mm	0.183 kg/m	DY200012050	NDATL-23	0.5 mm	0.121 kg/m
Mã mới	Mã cũ	Độ dày	Trọng lượng	Mã mới	Mã cũ	Độ dày	Trọng lượng	Mã mới	Mã cũ	Độ dày	Trọng lượng
DY200013040	NDATL-18B	0.4 mm	0.15 kg/m	DY200013050	NDATL-18B	0.4 mm	0.15 kg/m	DY200015055	DY9754A	0.55 mm	0.124 kg/m
Mã mới	Mã cũ	Độ dày	Trọng lượng	Mã mới	Mã cũ	Độ dày	Trọng lượng	Mã mới	Mã cũ	Độ dày	Trọng lượng
DY200016055	DY9753A	0.55 mm	0.114 kg/m	DY200019060	DY9762	0.9 mm	0.087 kg/m	DY200008060	TL-26	0.6 mm	0.9 kg/m
Mã mới	Mã cũ	Độ dày	Trọng lượng	Mã mới	Mã cũ	Độ dày	Trọng lượng	Mã mới	Mã cũ	Độ dày	Trọng lượng
DY200011050	NDATL-21	0.5 mm	0.112 kg/m	DY200020070	DY9763	0.7 mm	0.122 kg/m	DYT10001060	sk01	0.6 mm	0.247 kg/m
Mã mới	Mã cũ	Độ dày	Trọng lượng	Mã mới	Mã cũ	Độ dày	Trọng lượng				
DY200007060	TL-20	0.6 mm	0.139 kg/m	DY200019000	VA-9762	. mm	0.087 kg/m				

LÁ CHỚP

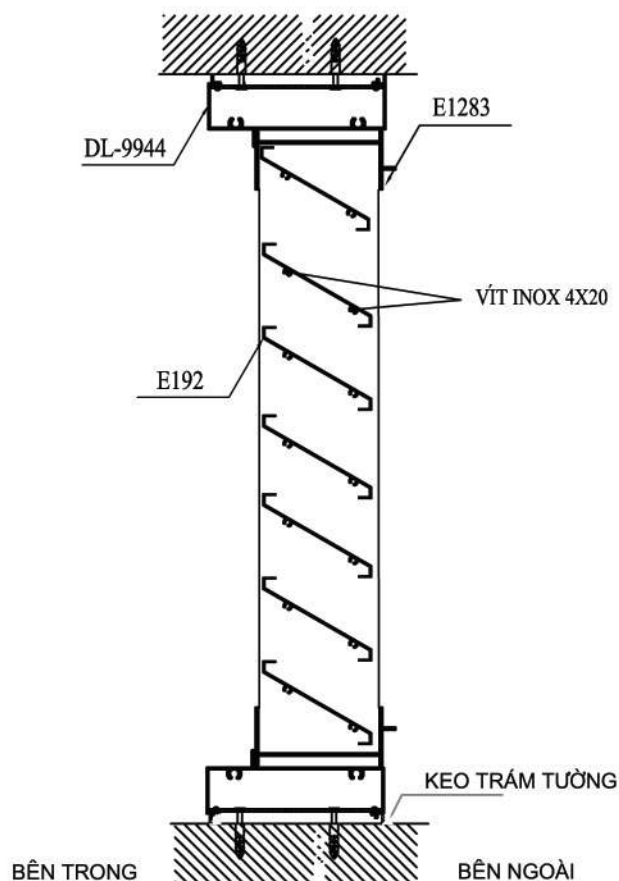
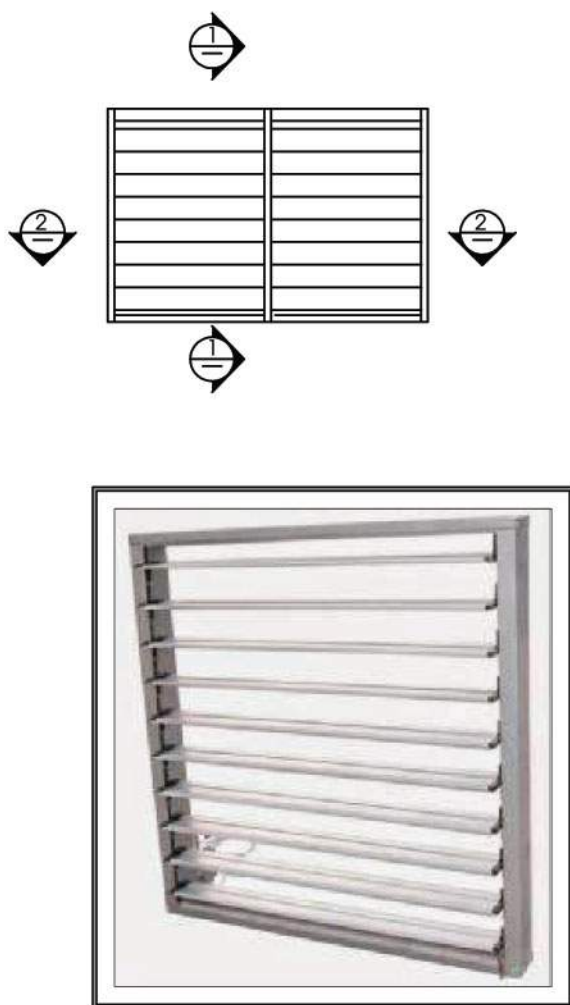

MẶT CẮT 1-1

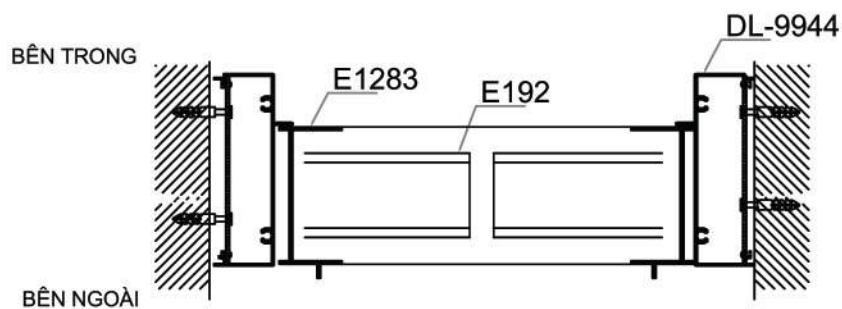

MẶT CẮT 2-2

LIST MẶT CẮT HỆ LÁ CHỚP

Mã mới	Mã cũ	Độ dày	Trọng lượng	Mã mới	Mã cũ	Độ dày	Trọng lượng	Mã mới	Mã cũ	Độ dày	Trọng lượng
DYT10086100	DL-9944	1.0 mm	0.454 kg/m	DY950020120	E1283	1.2 mm	0.308 kg/m	DY950023120	E192	1.2 mm	0.318 kg/m
Mã mới	Mã cũ	Độ dày	Trọng lượng	Mã mới	Mã cũ	Độ dày	Trọng lượng	Mã mới	Mã cũ	Độ dày	Trọng lượng
DYT10087100	DL-9946	1.0 mm	0.433 kg/m	DYT10053070	DAB.9902	0.7 mm	0.112 kg/m	DYT10084110	DL-9901	1.1 mm	0.245 kg/m
Mã mới	Mã cũ	Độ dày	Trọng lượng	Mã mới	Mã cũ	Độ dày	Trọng lượng	Mã mới	Mã cũ	Độ dày	Trọng lượng
								DYT10085100	DL-9936	1.0 mm	0.468 kg/m
Mã mới	Mã cũ	Độ dày	Trọng lượng	Mã mới	Mã cũ	Độ dày	Trọng lượng	Mã mới	Mã cũ	Độ dày	Trọng lượng
Mã mới	Mã cũ	Độ dày	Trọng lượng	Mã mới	Mã cũ	Độ dày	Trọng lượng	Mã mới	Mã cũ	Độ dày	Trọng lượng

CỬA CUỐN

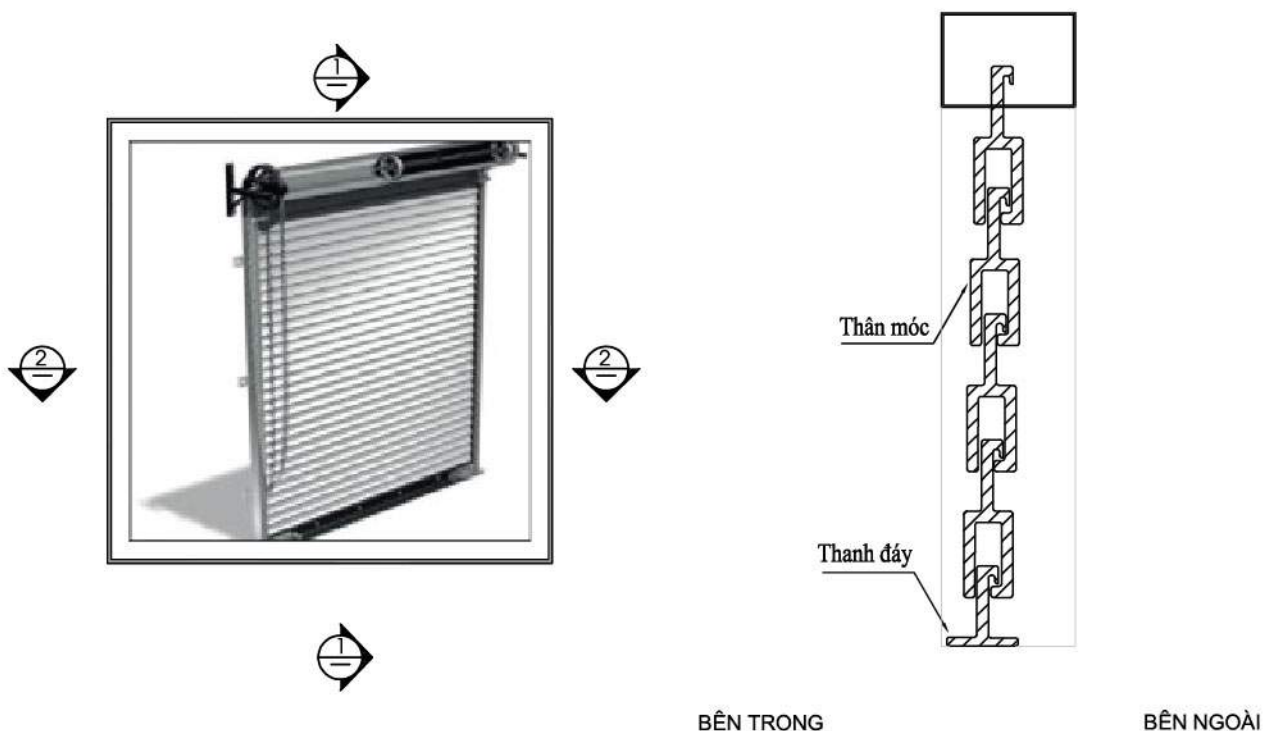

MẶT CẮT 1-1

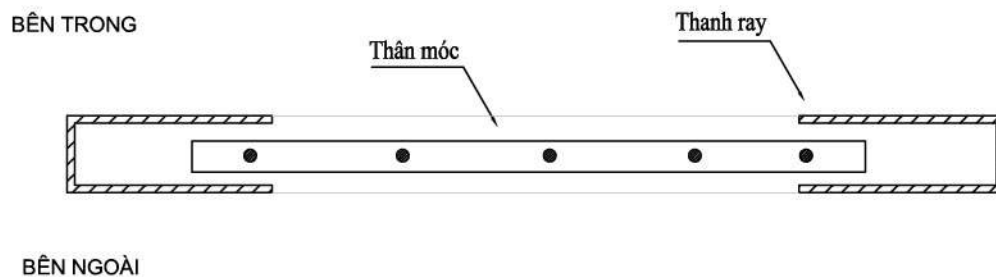















MẶT CẮT 2-2

LIST MẶT CẮT HỆ CỬA CUỐN

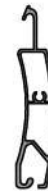
Thân móc											
Mã mới	Mã cũ	Độ dày	Trọng lượng	Mã mới	Mã cũ	Độ dày	Trọng lượng	Mã mới	Mã cũ	Độ dày	Trọng lượng
DYA10004120	VQ-03	1.2 mm	0.524kg/m	DYA10005080	VQ-04	0.8 mm	0.39 kg/m	DYA10006120	VQ-01	1.2 mm	0.53 kg/m
Mã mới	Mã cũ	Độ dày	Trọng lượng	Mã mới	Mã cũ	Độ dày	Trọng lượng	Mã mới	Mã cũ	Độ dày	Trọng lượng
DYA10101120	AD5090	1.2 mm	0.598 kg/m	DYA10014000	TP-06	0.6 mm	0.293 kg/m	DYA10018000	Decker-1.0	1.0 mm	0.484 kg/m
Mã mới	Mã cũ	Độ dày	Trọng lượng	Mã mới	Mã cũ	Độ dày	Trọng lượng	Mã mới	Mã cũ	Độ dày	Trọng lượng
DYA10019000	Decker-1.2	1.2 mm	0.539 kg/m	DYA10020000	Decker-1.3	1.3 mm	0.553 kg/m	DYA10021000	A43-1.0	1.0 mm	0.46 kg/m
Mã mới	Mã cũ	Độ dày	Trọng lượng	Mã mới	Mã cũ	Độ dày	Trọng lượng	Mã mới	Mã cũ	Độ dày	Trọng lượng
DYA10022000	KT1	0.1 mm	0.477 kg/m	DYA10023095	DY-A4303	0.95 mm	0.463 kg/m	DYA10017000	TP-09	2.4 mm	0.44 kg/m













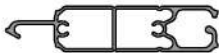

LIST MẶT CẮT HỆ CỬA CUỐN

											
Mã mới	Mã cũ	Độ dày	Trọng lượng	Mã mới	Mã cũ	Độ dày	Trọng lượng	Mã mới	Mã cũ	Độ dày	Trọng lượng
DYA10024115	DY-A4801	1.15 mm	0.56 kg/m	DYA10025135	A5001	1.35 mm	0.644 kg/m	DYA10029000	TS.55	0.8mm	0.367 kg/m
											
Mã mới	Mã cũ	Độ dày	Trọng lượng	Mã mới	Mã cũ	Độ dày	Trọng lượng	Mã mới	Mã cũ	Độ dày	Trọng lượng
DYA10030000	KS.43I	1.4 mm	0.568 kg/m	DYA10031000	KS.43A	1.1 mm	0.487 kg/m	DYA10032000	KS.45B	0.8 mm	0.376 kg/m
											
								Mã mới	Mã cũ	Độ dày	Trọng lượng
DYA10426000	D10B		0.448 kg/m	DYA10425000	D10A		0.504 kg/m	DYA10037000	KS.43F	1.4 mm	0.613 kg/m
											
Mã mới	Mã cũ	Độ dày	Trọng lượng	Mã mới	Mã cũ	Độ dày	Trọng lượng	Mã mới	Mã cũ	Độ dày	Trọng lượng
DYA10038000	KS.43A	1.1 mm	0.487 kg/m	DYA10039000	KS.45	0.8 mm	0.39 kg/m	DYA10040000	KS.50C	1.0 mm	0.456 kg/m
											
Mã mới	Mã cũ	Độ dày	Trọng lượng	Mã mới	Mã cũ	Độ dày	Trọng lượng	Mã mới	Mã cũ	Độ dày	Trọng lượng
DYA10041000	KS.55V	0.8 mm	0.367 kg/m	DYA10045095	Dacker-0.95	0.95 mm	0.467 kg/m	DYA10046090	A43E	0.9 mm	0.437 kg/m

LIST MẶT CẮT HỆ CỬA CUỐN

Mã mới	Mã cũ	Độ dày	Trọng lượng	Mã mới	Mã cũ	Độ dày	Trọng lượng	Mã mới	Mã cũ	Độ dày	Trọng lượng
DYA10047150	VQ.02A	1.5 mm	0.704 kg/m	DYA10048160	VQ.10	1.6 mm	0.713 kg/m	DYA10049110	VQ.09	1.1 mm	0.604 kg/m
Mã mới	Mã cũ	Độ dày	Trọng lượng	Mã mới	Mã cũ	Độ dày	Trọng lượng	Mã mới	Mã cũ	Độ dày	Trọng lượng
DYA10050130	VQ.11	1.3 mm	0.623 kg/m	DYA10051140	N200	1.4 mm	0.588 kg/m	DYA10100100	AD4502	1.0 mm	0.464 kg/m
Mã mới	Mã cũ	Độ dày	Trọng lượng	Mã mới	Mã cũ	Độ dày	Trọng lượng	Mã mới	Mã cũ	Độ dày	Trọng lượng
DYA10053090	A48	0.9 mm	0.428 kg/m	DYA10054130	A50I	1.3 mm	0.610 kg/m	DYA10090150	N211	1.5 mm	0.653 kg/m
Mã mới	Mã cũ	Độ dày	Trọng lượng	Mã mới	Mã cũ	Độ dày	Trọng lượng	Mã mới	Mã cũ	Độ dày	Trọng lượng
DYA10170110	NS48	1.1 mm	0.575 kg/m	DYA10170125	AD4501	1.25 mm	0.554 kg/m	DYA10171080	NE44	0.8 mm	0.349 kg/m
Mã mới	Mã cũ	Độ dày	Trọng lượng	Mã mới	Mã cũ	Độ dày	Trọng lượng	Mã mới	Mã cũ	Độ dày	Trọng lượng
DYA10172090	TA44.0.9	0.9 mm	0.457 kg/m	DYA10173110	TA44.1.1	1.1 mm	0.511 kg/m	DYA10174100	TA45.1.0	1.0 mm	0.497 kg/m









LIST MẶT CẮT HỆ CỬA CUỐN

											
Mã mới	Mã cũ	Độ dày	Trọng lượng	Mã mới	Mã cũ	Độ dày	Trọng lượng	Mã mới	Mã cũ	Độ dày	Trọng lượng
DYA10164110	TA45C.1.1	1.1 mm	0.476 kg/m	DYA10165090	TA45C.0.9	0.9 mm	0.431kg/m	DYA10451140	QM-793	1.14 mm	0.521 kg/m
											
Mã mới	Mã cũ	Độ dày	Trọng lượng	Mã mới	Mã cũ	Độ dày	Trọng lượng	Mã mới	Mã cũ	Độ dày	Trọng lượng
DYA10167080	VQ.50	0.8 mm	0.45 kg/m	DYA10167140	AD-5097	1.4 mm	0.598 kg/m	DYA10156100	N46E	1.0 mm	0.499 kg/m
											
Mã mới	Mã cũ	Độ dày	Trọng lượng	Mã mới	Mã cũ	Độ dày	Trọng lượng	Mã mới	Mã cũ	Độ dày	Trọng lượng
DYA10157120	DT-N212S	1.2 mm	0.544 kg/m	DYA10158080	DT-N203S	0.8 mm	3.88 kg/m	DYA10157120	DT-N212S	1.2 mm	0.544 kg/m
											
Mã mới	Mã cũ	Độ dày	Trọng lượng	Mã mới	Mã cũ	Độ dày	Trọng lượng	Mã mới	Mã cũ	Độ dày	Trọng lượng
DYA10158080	DT-N203S	0.8 mm	0.388 kg/m	DYA10159100	AD4810	1.0 mm	0.511 kg/m	DYA10160100	AD5010	1.0 mm	0.522 kg/m
											
Mã mới	Mã cũ	Độ dày	Trọng lượng	Mã mới	Mã cũ	Độ dày	Trọng lượng	Mã mới	Mã cũ	Độ dày	Trọng lượng
DYA10161130	TA45C.1.3	1.3 mm	0.556 kg/m	DYA10162130	TA44.1.3	1.3 mm	0.57 kg/m	DYA10168085	AD-5098	0.85 mm	0.429 kg/m

LIST MẶT CẮT HỆ CỬA CUỐN

Mã mới	Mã cũ	Độ dày	Trọng lượng	Mã mới	Mã cũ	Độ dày	Trọng lượng	Mã mới	Mã cũ	Độ dày	Trọng lượng
DYA10476000	D12A		0.547 kg/m	DYA10477000	D12B		0.527 kg/m	DYA10480140	DA02	1.4 mm	0.624 kg/m
Mã mới	Mã cũ	Độ dày	Trọng lượng	Mã mới	Mã cũ	Độ dày	Trọng lượng	Mã mới	Mã cũ	Độ dày	Trọng lượng
DYA10481120	DA03	1.2 mm	0.562 kg/m	DYA10482100	DA04	1.0 mm	0.500 kg/m	DYA10487140	DA02 Rev1	1.4 mm	0.621 kg/m
Mã mới	Mã cũ	Độ dày	Trọng lượng	Mã mới	Mã cũ	Độ dày	Trọng lượng	Mã mới	Mã cũ	Độ dày	Trọng lượng
DYA10488120	DA03 Rev1	1.2 mm	0.56 kg/m	DYA10489100	DA04 Rev1	1.0 mm	0.497 kg/m	DYT00001	TLU-01	1.2 mm	0.559 kg/m
Mã mới	Mã cũ	Độ dày	Trọng lượng	Mã mới	Mã cũ	Độ dày	Trọng lượng	Mã mới	Mã cũ	Độ dày	Trọng lượng
DYT00002	TLU-02	1.0 mm	0.487 kg/m	DYA10343220	B100	2.2 mm	1.697 kg/m	DYA10468000	DA-D11A		0.536 kg/m
Mã mới	Mã cũ	Độ dày	Trọng lượng	Mã mới	Mã cũ	Độ dày	Trọng lượng	Mã mới	Mã cũ	Độ dày	Trọng lượng
DYA10472000	S50qa		0.607 kg/m	DYA10473000	S50qb		0.548 kg/m	DYA10475000	D09B		0.445 kg/m







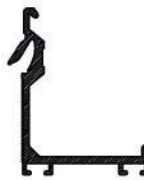
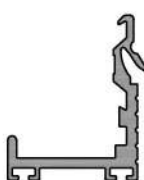
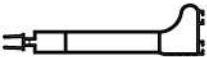

LIST MẶT CẮT HỆ CỬA CUỐN

											
Mã mới	Mã cũ	Độ dày	Trọng lượng	Mã mới	Mã cũ	Độ dày	Trọng lượng	Mã mới	Mã cũ	Độ dày	Trọng lượng
DYA10422000	S50P		0.602 kg/m	DYA10423000	D09A		0.47 kg/m	DYA10002100	TLU-02	1.0 mm	0.487 kg/m
											
Mã mới	Mã cũ	Độ dày	Trọng lượng	Mã mới	Mã cũ	Độ dày	Trọng lượng	Mã mới	Mã cũ	Độ dày	Trọng lượng
DYA10001120	TLU-01	1.2 mm	0.559 kg/m	DYA10431000	A51-02		0.217 kg/m	DYA10432000	A51-03		0.216 kg/m
											
Mã mới	Mã cũ	Độ dày	Trọng lượng	Mã mới	Mã cũ	Độ dày	Trọng lượng	Mã mới	Mã cũ	Độ dày	Trọng lượng
								DYA10003140	VQ-02	1.4 mm	0.6 kg/m
<h3>Thanh ray</h3>											
											
Mã mới	Mã cũ	Độ dày	Trọng lượng	Mã mới	Mã cũ	Độ dày	Trọng lượng	Mã mới	Mã cũ	Độ dày	Trọng lượng
DYA10433000	U65		0.837 kg/m					DYA10434000	U63		0.878 kg/m







LIST MẶT CẮT HỆ CỬA CUỐN

Mã mới	Mã cũ	Độ dày	Trọng lượng	Mã mới	Mã cũ	Độ dày	Trọng lượng	Mã mới	Mã cũ	Độ dày	Trọng lượng
DYA10007140	VQ-05	1.4 mm	0.715 kg/m	DYA10009000	TP-01	1.7 mm	0.814 kg/m	DYA10010000	TP-02	1.0 mm	0.723 kg/m
Mã mới	Mã cũ	Độ dày	Trọng lượng	Mã mới	Mã cũ	Độ dày	Trọng lượng	Mã mới	Mã cũ	Độ dày	Trọng lượng
DYA10012000	TP-04	1.0 mm	0.418 kg/m	DYA10400000	TD467		0.438 kg/m	DYA10028000	TS.37A	1.0 mm	0.362 kg/m
Mã mới	Mã cũ	Độ dày	Trọng lượng	Mã mới	Mã cũ	Độ dày	Trọng lượng	Mã mới	Mã cũ	Độ dày	Trọng lượng
DYA10035000	RS.76F	1.0 mm	0.77 kg/m	DYA10036000	RS.76H	1.0 mm	0.613 kg/m	DYA10043000	KD.37	1.0 mm	0.362 kg/m
Mã mới	Mã cũ	Độ dày	Trọng lượng	Mã mới	Mã cũ	Độ dày	Trọng lượng	Mã mới	Mã cũ	Độ dày	Trọng lượng
DYA10176170	TP01.1	1.7 mm	0.828 kg/m	DYA10177160	U601	1.6 mm	0.78 kg/m	DYA10484000	U85		1.111 kg/m
Mã mới	Mã cũ	Độ dày	Trọng lượng	Mã mới	Mã cũ	Độ dày	Trọng lượng	Mã mới	Mã cũ	Độ dày	Trọng lượng
DYA10435000	U66		0.798 kg/m	DYA10483000	UH105		1.852 kg/m	DYA10178130	U76I	1.3 mm	0.917 kg/m

LIST MẶT CẮT HỆ CỬA CUỐN

Thanh đáy											
											
Mã mới	Mã cũ	Độ dày	Trọng lượng	Mã mới	Mã cũ	Độ dày	Trọng lượng	Mã mới	Mã cũ	Độ dày	Trọng lượng
DYA10042000	KD.56	1.0 mm	0.478 kg/m	DYA10490180	D4534	1.8 mm.	0.521 kg/m	DYA10175000	DY-SM-LD.001		0.742 kg/m
											
Mã mới	Mã cũ	Độ dày	Trọng lượng	Mã mới	Mã cũ	Độ dày	Trọng lượng	Mã mới	Mã cũ	Độ dày	Trọng lượng
DYA10420000	TD468		1.051 kg/m	DYA10420000	TD468		1.051 kg/m	DYA10467000	AL10		1.172 kg/m
											
Mã mới	Mã cũ	Độ dày	Trọng lượng	Mã mới	Mã cũ	Độ dày	Trọng lượng	Mã mới	Mã cũ	Độ dày	Trọng lượng
DYA10026000	TS.09	1.0 mm	0.109 kg/m	DYA10044000	KD.08	0.1 mm	0.114 kg/m	DYA10169100	AD451	1.0mm	0.146 kg/m
											
Mã mới	Mã cũ	Độ dày	Trọng lượng	Mã mới	Mã cũ	Độ dày	Trọng lượng	Mã mới	Mã cũ	Độ dày	Trọng lượng
DYA10399000	TD463		0.15 kg/m	DYA10013000	TP-05	1.0 mm	0.151 kg/m				

LIST MẶT CẮT HỆ CỬA CUỐN

											
Mã mới	Mã cũ	Độ dày	Trọng lượng	Mã mới	Mã cũ	Độ dày	Trọng lượng	Mã mới	Mã cũ	Độ dày	Trọng lượng
DYA10008000	VQ-06	1.8 mm	0.513 kg/m	DYA10011000	TP-03	1.0 mm	0.618 kg/m	DYA10015000	TP-07		1.087 kg/m
											
Mã mới	Mã cũ	Độ dày	Trọng lượng	Mã mới	Mã cũ	Độ dày	Trọng lượng	Mã mới	Mã cũ	Độ dày	Trọng lượng
DYA10016000	TP-08	0.9 mm	0.423 kg/m	DYA10242140	QMI-395	1.4 mm	0.396 kg/m	DYA10027000	TS. 56	1.0 mm	0.478 kg/m
											
Mã mới	Mã cũ	Độ dày	Trọng lượng	Mã mới	Mã cũ	Độ dày	Trọng lượng	Mã mới	Mã cũ	Độ dày	Trọng lượng
DYA10490180	D4534	1.8 mm	0.521 kg/m								
Mã mới	Mã cũ	Độ dày	Trọng lượng	Mã mới	Mã cũ	Độ dày	Trọng lượng	Mã mới	Mã cũ	Độ dày	Trọng lượng
Mã mới	Mã cũ	Độ dày	Trọng lượng	Mã mới	Mã cũ	Độ dày	Trọng lượng	Mã mới	Mã cũ	Độ dày	Trọng lượng

LIST MẶT CẮT 1 SỐ HỆ KHÁC



DY - 55-80

DY - 55-80											
Mã mới	Mã cũ	Độ dày	Trọng lượng	Mã mới	Mã cũ	Độ dày	Trọng lượng	Mã mới	Mã cũ	Độ dày	Trọng lượng
DY550106140	DN1	1.4 mm	0.922 kg/m	DY550107140	DG1	1.4 mm	0.8 kg/m	DY550105140	ND1	1.4 mm	0.765 kg/m
Mã mới	Mã cũ	Độ dày	Trọng lượng	Mã mới	Mã cũ	Độ dày	Trọng lượng	Mã mới	Mã cũ	Độ dày	Trọng lượng
DY800506140	DN-H	1.4 mm	1.32 kg/m	DY800507140	DG-H	1.4 mm	1.168 kg/m	DY550104140	NT1	1.4 mm	0.576 kg/m
Mã mới	Mã cũ	Độ dày	Trọng lượng	Mã mới	Mã cũ	Độ dày	Trọng lượng	Mã mới	Mã cũ	Độ dày	Trọng lượng
DY550101140	KB1-2	1.4 mm	1.64 kg/m	DY800505140	ND-H	1.4 mm	1.325 kg/m	DY550108120	TG1	1.2 mm	0.453 kg/m
Mã mới	Mã cũ	Độ dày	Trọng lượng	Mã mới	Mã cũ	Độ dày	Trọng lượng	Mã mới	Mã cũ	Độ dày	Trọng lượng
DY800511140	KB	1.4 mm	2.16 kg/m	DY800504140	NT-H	1.4 mm	0.897 kg/m	DY800508120	TG	1.2 mm	0.485 kg/m

LIST MẶT CẮT 1 SỐ HỆ KHÁC

DY - 4000											
Mã mới	Mã cũ	Độ dày	Trọng lượng	Mã mới	Mã cũ	Độ dày	Trọng lượng	Mã mới	Mã cũ	Độ dày	Trọng lượng
DY400001100	NS. 4004	1 mm	0.543 kg/m	DY400002100	NS. 4003	1 mm	0.624 kg/m	DY400003100	NS. 4015	1 mm	0.621 kg/m
Mã mới	Mã cũ	Độ dày	Trọng lượng	Mã mới	Mã cũ	Độ dày	Trọng lượng	Mã mới	Mã cũ	Độ dày	Trọng lượng
DY400004100	NS. 4001	1 mm	0.222 kg/m	DY400007100	NS. 4014	1 mm	0.796 kg/m	DY400009100	NSS. 4023	1 mm	0.172 kg/m
Mã mới	Mã cũ	Độ dày	Trọng lượng	Mã mới	Mã cũ	Độ dày	Trọng lượng	Mã mới	Mã cũ	Độ dày	Trọng lượng
DY400011100	NSS. 4008	1 mm	0.608 kg/m	DY400012100	NSS. 4005	1 mm	0.627 kg/m	.	.	. mm	. kg/m
Mã mới	Mã cũ	Độ dày	Trọng lượng	Mã mới	Mã cũ	Độ dày	Trọng lượng	Mã mới	Mã cũ	Độ dày	Trọng lượng

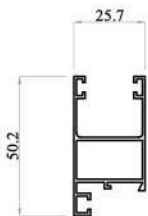
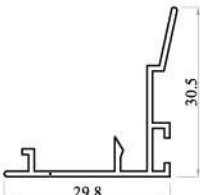
LIST MẶT CẮT 1 SỐ HỆ KHÁC

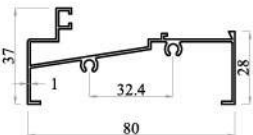
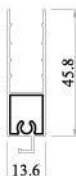
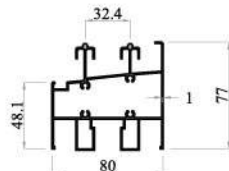
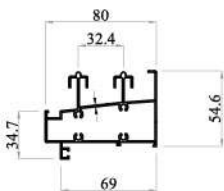
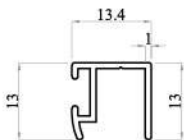
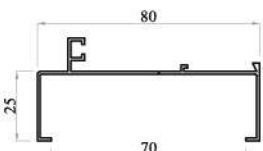
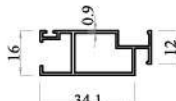
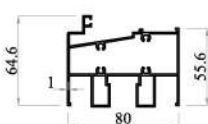
DY - 8000											
											
Mã mới	Mã cũ	Độ dày	Trọng lượng	Mã mới	Mã cũ	Độ dày	Trọng lượng	Mã mới	Mã cũ	Độ dày	Trọng lượng
DY800004100	VN8051	1.0 mm	0.488 kg/m	DY800005100	VN8052	1.0 mm	0.214 kg/m	DY800008100	VN8065	1.0 mm	0.206 kg/m
											
Mã mới	Mã cũ	Độ dày	Trọng lượng	Mã mới	Mã cũ	Độ dày	Trọng lượng	Mã mới	Mã cũ	Độ dày	Trọng lượng
DY800009100	VN8006	1.0 mm	0.581 kg/m	DY800010095	VN8061	0.95 mm	0.362 kg/m	DY800011100	VN8005	1.0 mm	1.6 kg/m
											
Mã mới	Mã cũ	Độ dày	Trọng lượng	Mã mới	Mã cũ	Độ dày	Trọng lượng	Mã mới	Mã cũ	Độ dày	Trọng lượng
DY800012100	VN8012	1.0 mm	1.235 kg/m	DY800014100	VN8004	1.0 mm	1.118 kg/m				
											
Mã mới	Mã cũ	Độ dày	Trọng lượng	Mã mới	Mã cũ	Độ dày	Trọng lượng	Mã mới	Mã cũ	Độ dày	Trọng lượng
DY800019100	VN8006A	1.0 mm	0.458 kg/m	DY800020090	VN8062	0.9 mm	0.306 kg/m	DY800021100	VN8007	1.0 mm	1.326 kg/m

LIST MẶT CẮT 1 SỐ HỆ KHÁC

DY - 8000											
Mã mới	Mã cũ	Độ dày	Trọng lượng	Mã mới	Mã cũ	Độ dày	Trọng lượng	Mã mới	Mã cũ	Độ dày	Trọng lượng
DY800035100	DL-VN8057A	1.0 mm	0.222 kg/m	DY800039100	VN8009	1.0 mm	0.976 kg/m	DY800044220	VN8460		0.313 kg/m
Mã mới	Mã cũ	Độ dày	Trọng lượng	Mã mới	Mã cũ	Độ dày	Trọng lượng	Mã mới	Mã cũ	Độ dày	Trọng lượng
DY800054100	DQ613	1.0 mm	0.519kg/m	DY800064080	DQ614	0.8 mm	0.083 kg/m	DY800074140	1251	1.4 mm	0.324 kg/m
Mã mới	Mã cũ	Độ dày	Trọng lượng	Mã mới	Mã cũ	Độ dày	Trọng lượng	Mã mới	Mã cũ	Độ dày	Trọng lượng
DY800001100	N8001	0.1 mm	0.815 kg/m	DY800002100	VN8002	1.0 mm	0.906 kg/m	DY800003100	VN8003	1.0 mm	0.417 kg/m
Mã mới	Mã cũ	Độ dày	Trọng lượng	Mã mới	Mã cũ	Độ dày	Trọng lượng	Mã mới	Mã cũ	Độ dày	Trọng lượng
DY800024100	VN8054	1.0 mm	0.107 kg/m	DY800029100	VN8008	1.0 mm	0.941 kg/m	DY800034100	VN8057	1.0 mm	0.235 kg/m

LIST MẶT CẮT 1 SỐ HỆ KHÁC

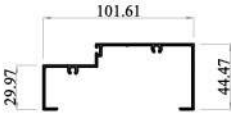
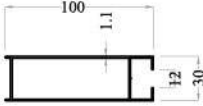
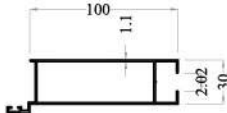
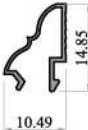
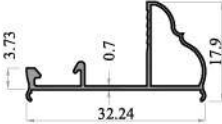
DY - 1001											
											
Mã mới	Mã cũ	Độ dày	Trọng lượng	Mã mới	Mã cũ	Độ dày	Trọng lượng	Mã mới	Mã cũ	Độ dày	Trọng lượng
DY100101110	PS008	1.1 mm	0.692 kg/m	DY100103110	PS088	1.1 mm	0.826 kg/m	DY100104110	PS087	1.1 mm	0.92 kg/m
											
Mã mới	Mã cũ	Độ dày	Trọng lượng	Mã mới	Mã cũ	Độ dày	Trọng lượng	Mã mới	Mã cũ	Độ dày	Trọng lượng
DY100105070	DY-010	0.7 mm	0.065 kg/m	DY100110070	DY-009	0.7 mm	0.145 kg/m				
Mã mới	Mã cũ	Độ dày	Trọng lượng	Mã mới	Mã cũ	Độ dày	Trọng lượng	Mã mới	Mã cũ	Độ dày	Trọng lượng
Mã mới	Mã cũ	Độ dày	Trọng lượng	Mã mới	Mã cũ	Độ dày	Trọng lượng	Mã mới	Mã cũ	Độ dày	Trọng lượng

LIST MẶT CẮT 1 SỐ HỆ KHÁC

DY - 7007											
Mã mới	Mã cũ	Độ dày	Trọng lượng	Mã mới	Mã cũ	Độ dày	Trọng lượng	Mã mới	Mã cũ	Độ dày	Trọng lượng
DY700704140	1254	1.4 mm	0.548 kg/m	DY700705140	1252	1.4 mm	1.330 kg/m	DY700706140	1253	1.4 mm	1.419 kg/m
Mã mới	Mã cũ	Độ dày	Trọng lượng	Mã mới	Mã cũ	Độ dày	Trọng lượng	Mã mới	Mã cũ	Độ dày	Trọng lượng
DY700707140	1251	1.4 mm	1.3240kg/m	DY700710110	1203	1.1m	0.272 kg/m	DY700711130	5301B	1.3 mm	0.6 kg/m
Mã mới	Mã cũ	Độ dày	Trọng lượng	Mã mới	Mã cũ	Độ dày	Trọng lượng	Mã mới	Mã cũ	Độ dày	Trọng lượng
DY700713130	5302	1.3 mm	1.385 kg/m	DY700714120	1354	1.2 mm	0.503 kg/m	DY700715120	1352	1.2 mm	0.849 kg/m
Mã mới	Mã cũ	Độ dày	Trọng lượng	Mã mới	Mã cũ	Độ dày	Trọng lượng	Mã mới	Mã cũ	Độ dày	Trọng lượng
DY700716120	1353	1.2 mm	0.972 kg/m	DY700717120	1351	1.2 mm	1.031 kg/m	DY700720100	5305	1.0 mm	0.222 kg/m



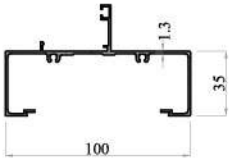
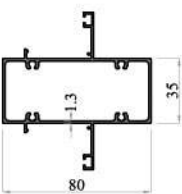
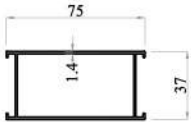
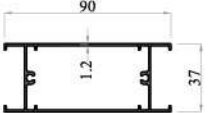
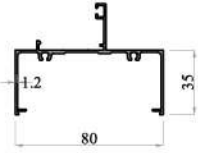
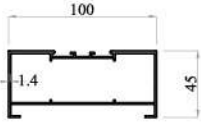
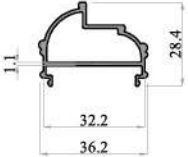
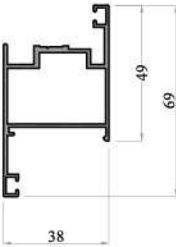
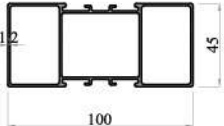
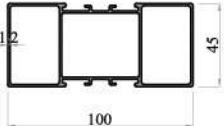





























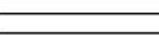
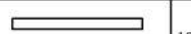

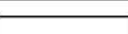
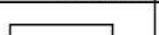

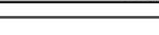



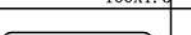

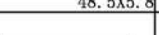



LIST MẶT CẮT 1 SỐ HỆ KHÁC

DY - 7007											
											
Mã mới	Mã cũ	Độ dày	Trọng lượng	Mã mới	Mã cũ	Độ dày	Trọng lượng	Mã mới	Mã cũ	Độ dày	Trọng lượng
DY700721120	5301	1.3 mm	0.946 kg/m	DY700723130	8302	1.3 mm	1.214 kg/m	DY700724140	1255	1.4 mm	0.776 kg/m
											
Mã mới	Mã cũ	Độ dày	Trọng lượng	Mã mới	Mã cũ	Độ dày	Trọng lượng	Mã mới	Mã cũ	Độ dày	Trọng lượng
DY700727120	1351A	1.2 mm	0.901 kg/m	DY700731120	8301	1.2 mm	0.776 kg/m	DY700731140	1201	1.4 mm	1.174 kg/m
											
Mã mới	Mã cũ	Độ dày	Trọng lượng	Mã mới	Mã cũ	Độ dày	Trọng lượng	Mã mới	Mã cũ	Độ dày	Trọng lượng
DY700701110	1204	1.1 mm	0.382 kg/m	DY700702120	5303	1.2 mm	0.763 kg/m	DY700703120	1210	1.2 mm	1.342 kg/m
											
Mã mới	Mã cũ	Độ dày	Trọng lượng	Mã mới	Mã cũ	Độ dày	Trọng lượng	Mã mới	Mã cũ	Độ dày	Trọng lượng





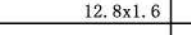













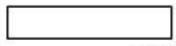

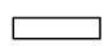















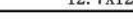

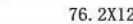







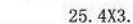

MẶT CẮT 1 SỐ THANH NHÔM TIÊU BIỂU

Mã mới	Mã cũ	Độ dày	Trọng lượng	Mã mới	Mã cũ	Độ dày	Trọng lượng	Mã mới	Mã cũ	Độ dày	Trọng lượng
DY100201120	.	1.2 mm	0.732 kg/m	DY100211120	.	1.2 mm	1.024 kg/m	DY100221120	.	1.2	0.982 kg/m
Mã mới	Mã cũ	Độ dày	Trọng lượng	Mã mới	Mã cũ	Độ dày	Trọng lượng	Mã mới	Mã cũ	Độ dày	Trọng lượng
DY760011070	.	0.7 mm	0.284 kg/m	DY760012070	.	0.7 mm	0.411 kg/m	DY108903120	DL-10894	1.2 mm	0.662 kg/m
Mã mới	Mã cũ	Độ dày	Trọng lượng	Mã mới	Mã cũ	Độ dày	Trọng lượng	Mã mới	Mã cũ	Độ dày	Trọng lượng
DY108909120	DL-10896	1.2 mm	0.715 kg/m	DY760003070	.	0.7 mm	0.404 kg/m	DY108913120	DL-10895	1.2 mm	0.662 kg/m
Mã mới	Mã cũ	Độ dày	Trọng lượng	Mã mới	Mã cũ	Độ dày	Trọng lượng	Mã mới	Mã cũ	Độ dày	Trọng lượng
DY108919120	DL-10897	1.2 mm	1.143 kg/m	DY700111080	DSY-7019	0.8 mm	0.352 kg/m	DY700131120	DN-7019	1.0 mm	0.447 kg/m
Mã mới	Mã cũ	Độ dày	Trọng lượng	Mã mới	Mã cũ	Độ dày	Trọng lượng	Mã mới	Mã cũ	Độ dày	Trọng lượng
DY700659070	DY-7019	0.7 mm	0.311 kg/m	DY760001070	DA7019	0.7 mm	0.308 kg/m	DY760002070	DA7011	0.7 mm	0.428 kg/m

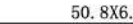















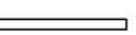



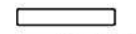



























MẶT CẮT 1 SỐ THANH NHÔM TIÊU BIỂU

THANH THẲNG											
DIE #	Sectional cross	Wall Thickness (mm)	Drawing weight (kg/m)	DIE #	Sectional cross	Wall Thickness (mm)	Drawing weight (kg/m)	DIE #	Sectional cross	Wall Thickness (mm)	Drawing weight (kg/m)
DYG10190157 DY-31296	 25.4x1.57	1.57	0.108	DYT10230150 E4330	 100X1.5	1.5	0.405	DYT10209300 E4005	 16X3	3.0	0.13
DYG10045000 DY-MA.01	 15x3	#	0.121	DYT10116400 E4024	 50X4	4	0.54	DYT10210300 E4006	 20X3	3.0	0.162
DYG10047000 DY-MA.03	 13x2.3	#	0.078	DYT10235500 PM00416	 50X5	5	0.675	DYT10211300 E4007	 25X3	3.0	0.202
DYG10070635	 50.8x6.35	6.35	0.874	DYT10213300 E4009	 40X3	3	0.325	DYT10212300 E4008	 32X3	3.0	0.259
DYG10071635	 76.2x6.35	6.35	1.311	DYT10204300 E4000	 10X3	3	0.081	DYT10216300 E4012	 100X3	3.0	0.81
DYG10072635	 76.2x6.35	6.35	1.748	DYT10205160 E4001	 12X1.6	1.6	0.052	DYT10214300 E4010	 50X3	3.0	0.405
DYG10081635	 101.6x6.35	6.35	2.185	DYT10206160 E4002	 20X1.6	1.6	0.086	DYT10217600 E4013	 40X6	6.0	0.648
DYT10741000 CDW-92	 19.05x3.18		0.164	DY10207160 E4003	 25X1.6	1.6	0.108	DYT10218600 E4014	 50X6	6.0	0.81
DYG10357127 C-1055355	 152.4x12.7	12.7	5.284	DYT10208300 E4004	 12X3	3	0.097	DYT10221100 E4017	 40X10	10.0	1.08
DYG10547600 AA050	 50x6	6.0	0.813	DYT10232100 ME 4001	 32X10	10.0	0.864	DYT10222100 E4018	 50X10	10.0	1.35
DYG10553150	 100X1.5	1.5	0.406	DYT10234300 PM 00083	 60X3	3.0	0.486	DYT10223100 E4019	 100X10	10.0	2.7
DYG10557580 AA0347	 48.5X5.8	5.8	0.743	DYT10233100 PM 00050	 25X10	10.0	0.675	DYT10224120 E4021	 100X12	12.0	3.24
DYG10546500 AA037	 40X5	5.0	0.542	DYT10215300 E4011	 80X3	3.0	0.648	DYT10225400 E4023	 25X4	4.0	0.27
DYG10548600 AA080	 100X6	6.0	1.626	DYT10219600 E4015	 80X6	6.0	1.296	DYT10227600 E4028	 25X6	6.0	0.405
DYA10240200	 53x2	2.0	0.279	DYT10220600 E4016	 100X6	6.0	1.62	DYT10228600 E4030	 32X6	6.0	0.518
DYG10595160 MA.05	 12.8x1.6	1.6	0.054	DYT10330600 AA0178	 106X6	6.0	2.602	DYT10229100 E4031	 80X10	10.0	2.16
DYG10170600 AA043	 40X6	6	0.65	DYT10337100 AA012	 20X10	10	0.542	DYT10231120 ME 0011	 50X12	12.0	1.62

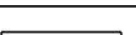



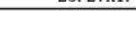

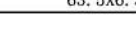





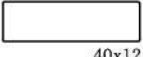























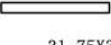

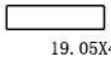



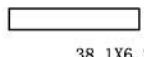

MẶT CẮT 1 SỐ THANH NHÔM TIÊU BIỂU

THANH THẲNG											
DIE #	Sectional cross	Wall Thickness (mm)	Drawing weight (kg/m)	DIE #	Sectional cross	Wall Thickness (mm)	Drawing weight (kg/m)	DIE #	Sectional cross	Wall Thickness (mm)	Drawing weight (kg/m)
DYG10766000 312066063	 9. 53X9. 53		0. 247	DYT10359100 AA090	 100X10	10	2. 71	DYT10410000 ME0003050	 40X20		2. 16
DYG10767476 34203326063	 203. 2X4. 76	4. 76	2. 604	DYT10358300 AA048	 50X3	3	0. 406	DYT10389000 ME0003053	 100X4		1. 079
DYG10770635 3420420	 127X6. 35	6. 35	2. 177	DYG11177000 AA053	 50X10		1. 354	DYT1039000 ME0004017	 80X16		3. 456
DYG10773635 3420416	 101. 6X6. 35	6. 35	1. 75	DYG10769635 3420404	 25. 4X6. 35	6. 35	0. 44	DYF10288000 ME0002510	 6X6		0. 097
DYG10776953 3420608	 50. 8X9. 53	9. 53	1. 321	DYT10365160 PE00E4025	 80X1. 6	1. 6	0. 346	DYT10374000 ME0003366	 50X25		3. 374
DYG10782953 3420612	 76. 2X9. 53	9. 53	1. 976	DYG11009000 ME0000211	 100X25		6. 75	DYT10373000 ME0003111	 80X12		2. 591
DYG10777318 3420208	 50. 8X3. 18	3. 18	0. 44	DYF10253000 ME0003113	 80X25		5. 4	DYT10359600 PM0000049	 60X6	6	0. 972
DYG10775476 3420306	 38. 1X4. 76	4. 76	0. 486	DYT10338600 PE00E4166	 160X6	6	2. 59	DYT10371000 ME0003364	 20X10		0. 539
DYG10774000 31208	 12. 7X12. 7		0. 44	DYF10252000 ME0003047	 50X50		6. 747	DYT10355120 FA0000585	 60X12	12	1. 944
DYG10785127 3420812	 76. 2X12. 7	12. 7	2. 611	DYF10251000 PE00E8001	 12X12		0. 388	DYT10353000 ME0003112	 40X25		2. 699
DYG10778127 3420820	 127X12. 7	12. 7	4. 403	DYT10347000 PE00E4029	 20X6		0. 324	DYT10370150 ME0002511	 150X1. 5	1. 5	0. 61
DYT10342318 3420204	 25. 4X3. 18	3. 18	0. 22	DYT10348000 ME0002504	 80X4		0. 864	DYG11129000 ME0003608	 131X1. 3	1. 3	0. 542
DYT10341635 3420408	 50. 8X6. 35	6. 35	0. 88	DYT10349000 ME0000009	 40X4		0. 432	DYF10285000 PE00E8003	 25X25		1. 693
DYG10784127 3420816	 101. 6X12. 7	12. 7	3. 487	DYT10335250 AA062	 50X25	25	3. 387	DYF10286000 PE00E8002	 20X20		1. 084
DYG10781635 3420424	 152. 4X6. 35	6. 35	2. 617	DYT10336250 AA095	 100X25	25	6. 775	DYG10339000	 38. 1X4. 76		0. 495
DYT10328300 AA059	 80X3	3	0. 65	DYT10324100 AA038	 32X10	10	0. 867	DYT10356300 AA040	 40X3	3	0. 325
DYT10351000 PM0000196	 60X10		1. 62	DYT10325100 AA045	 40X10	10	1. 084	DYT10357400 AA041	 40X4	4	0. 433

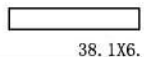
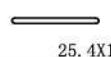

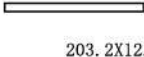
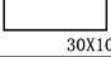
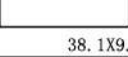







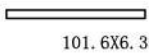
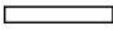
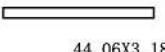





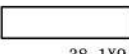



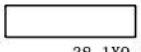







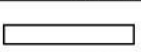

MẶT CẮT 1 SỐ THANH NHÔM TIÊU BIỂU

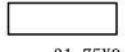
THANH THẲNG											
DIE #	Sectional cross	Wall Thickness (mm)	Drawing weight (kg/m)	DIE #	Sectional cross	Wall Thickness (mm)	Drawing weight (kg/m)	DIE #	Sectional cross	Wall Thickness (mm)	Drawing weight (kg/m)
DYT10439317 C009A	 76. 2X3. 17	3. 17	0. 657	DYT10440312 C010A	 63. 5X3. 12	3. 12	0. 541	DYT10696400	 32X4	4. 0	0. 349
DYT10470470 C009	 76. 2X4. 7	4. 7	0. 978	DYT10442476 C011	 50. 8X4. 76	4. 76	0. 658	DYT10700320 D00330	 25. 5X3. 2	3. 2	0. 222
DYT10471476 C008-4. 76	 101. 6X4. 76	4. 76	1. 32	DYT10441315 C014	 38. 1X3. 15	3. 15	0. 327	DYT10774152 ES12252	 15. 88x25. 4	1. 52	0. 264
DYT10472476 C010	 63. 5X4. 76	4. 76	0. 825	DYT10435312 C015A	 12. 7X3. 12	3. 12	0. 108	DYT10775000 ES05485	 19. 05x3. 18	.	0. 165
DYT10468620 C032	 25. 25X6. 2	6. 2	0. 427	DYT10494190	 101. 6X19. 05	1. 9	5. 284	DYT10526000	 152. 4x9. 53	.	3. 934
DYT10461000 AA015	 25X3	.	0. 203	DYT10493953	 101. 6X9. 53	9. 53	2. 642	DYF10727000 CA0000401	 110x16	.	4. 743
DYT10478317 C008-3. 175	 101. 6X3. 175	3. 175	0. 88	DYt10495100 WE000428	 75x10	1. 0	2. 024	DYF10741000 ME0001440	 150x6	6. 00	2. 430
DYT10469470 C030	 25. 4X4. 7	4. 7	0. 326	DYT10401319 070343	 76. 2X3. 18	3. 18	0. 66	DYF10731000 ME06180	 80x8	.	1. 728
DYT10425000 ME0005055	 25X3	.	0. 202	DYT10507000 PE00E4022	 160X12	.	5. 184	DYT10702000 FL2025	 25X20	.	1. 350
DYT10467230 AA089	 8X2. 3	2. 3	0. 05	DYT10553000 E14044-R0	 15. 88x3. 18	.	0. 136	DYT10796000 FB1308. 0	 130X8	.	2. 808
DYT10415600 ME0004002	 50X6	6	0. 789	DYT10526000	 152. 4x9. 53	.	3. 934	DYT10812305 3854	 15. 87x3. 05	3. 05	0. 131
DYT10402000 BE0000004	 50X20	.	2. 699	DYT10550000 ME0002102	 50X1. 5	.	0. 202	DYT10850127	 50. 8X12. 7	12. 7	1. 748
DYT10403000 ME0000049	 160X6	.	2. 592	DYT10630000 ME0003054	 160x4	.	1. 727	DYT10851318	 38. 1X3. 18	3. 18	0. 328
DYT10404000 ME0002547	 40X16	.	1. 727	DYT10604000 E4035	 160x10	.	4. 320	DYT10852318	 12. 7X3. 18	3. 18	0. 109
DYT10405000 ME0003365	 20X12	.	0. 647	DYT10508000 WE0000822	 50x8	1. 0	1. 08	DYT10845178 14220	 25. 27X1. 78	1. 78	0. 121
DYT10406000 ME0003527	 16X16	.	0. 691	DYT10569100 ME4003	 160x10	10. 0	4. 32	DYT10884635	 63. 5X6. 35	6. 35	1. 093
DYT10407000 BE0001711	 160X25	.	10. 799	DYT10546000 PE00E4327	 125x6	.	2. 025	DYT10883476	 76. 2X4. 76	4. 76	0. 984



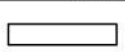

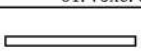













































MẶT CẮT 1 SỐ THANH NHÔM TIÊU BIỂU

THANH THẲNG											
MÃ SỐ	MẶT CẮT	ĐỘ DÀY (mm)	TRỌNG LƯỢNG (kg/m)	MÃ SỐ	MẶT CẮT	ĐỘ DÀY (mm)	TRỌNG LƯỢNG (kg/m)	MÃ SỐ	MẶT CẮT	ĐỘ DÀY (mm)	TRỌNG LƯỢNG (kg/m)
DYF10546000 ME0005440		8X8	0.172	DYT11110000		50.8X25.4	3.497	DYT10469470 C030		25.4X4.7	4.7 0.326
DYT10565000 ME0003166		40x12	1.295	DYT11111000		44.45X31.75	3.824	DYT10425000 ME0005055		25X3	0.202
DYF10612000 ME0003122		40x40	4.318	DYT11052000		50.8X38.1	5.245	DYG10190157 DY-31296		25.4x1.57	1.57 0.108
DYF10630000 E8006		10x10	0.270	DYT11100000		31.75X31.75	2.732	DYT10225400 E4023		25X4	4.0 0.27
DYF10546000 ME0005440		8X8	0.172	DYT11101000		25.4X19.05	1.311	DYT10227600 E4028		25X6	6.0 0.405
DYF10662000 ME0003754		10x12	0.324	DYT11102000		76.2X19.05	3.934	DYT10342318 3420204		25.4X3.18	3.18 0.22
DYF10651000 ME0002930		12x4	0.129	DYT11141000 FB1251.6		125X1.6	0.542	DYG10769635 3420404		25.4X6.35	6.35 0.44
DYT10661000 E4020		20x4	0.216	DYT11138000 FB1501.6		150X1.6	0.650	DYT10468620 C032		25.25X6.2	6.2 0.427
DYF10577600 E8004		12x6	6.0 0.151	DYT11135000		6.35X6.35	0.109	DYT10461000 AA015		25X3	3.0 0.203
DYT10916318		31.75X3.18	3.18 0.273	DYT11136000		19.05X19.05	0.983	DYT10700320 D00330		25.5X3.2	3.2 0.222
DYT10998475 CIA-E067		19.05X4.75	4.75 0.245	DYT11148000		127X25.4	8.742	DYT10845178 14220		25.27X1.78	1.78 0.121
DYT10874500 E16668		25.4X5	5.0 0.344	DYT11166280 FB2.89.8		9.8X2.8	0.074	DY10956635		38.1X6.35	6.35 0.655
DYT10917160		50X1.6	1.6 0.217	DYT11191635		19.05X6.35	6.35 0.328	DYT10957127		63.5X12.7	12.7 2.185
DYT10233100 PM 00050		25X10	10.0 0.675	DYT11196318		60.33X3.18	3.18 0.519	DY10961635		38.1X6.35	6.35 0.655
DYT10930165 PART#5028		25.4X1.65	1.65 0.112	DYT10936953		88.9X9.53	9.53 2.295	DYT10958127		203.2X12.7	12.7 6.993
DYT10992000 BANCO0084-1		30X10	0.813	DYT10935953		38.1X9.53	9.53 0.983	DYT10959000		38.1X19.05	1.967
DYT10962000		25.4X25.4	1.748	DYT10937000		25.4X12.7	0.874	DYT10960000		50.8X19.05	2.622



















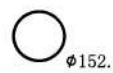

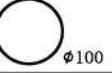









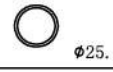

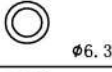
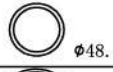

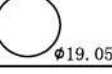

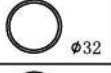
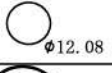

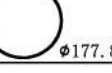

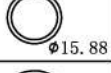

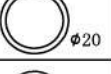
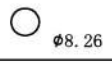
MẶT CẮT 1 SỐ THANH NHÔM TIÊU BIỂU

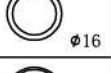
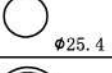
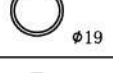
THANH THẲNG											
MÃ SỐ	MẶT CẮT	ĐỘ DÀY (mm)	TRỌNG LƯỢNG (kg/m)	MÃ SỐ	MẶT CẮT	ĐỘ DÀY (mm)	TRỌNG LƯỢNG (kg/m)	MÃ SỐ	MẶT CẮT	ĐỘ DÀY (mm)	TRỌNG LƯỢNG (kg/m)
DYT10773635	 101. 6X6. 35	6. 35	1. 75	DYT10982476	 31. 75X4. 76	4. 76	0. 41				
DYT10966318	 44. 06X3. 18	3. 18	0. 657	DYT10983953	 63. 5X9. 53	9. 53	1. 639				
DYT10970000	 19. 05X9. 53	9. 53	0. 491	DYT10937000	 25. 4X12. 7		0. 874				
DYT10565000 ME0003166	 40x12		1. 295	DYT10936953	 88. 9X9. 53	9. 53	2. 295				
DYF10577600 E8004	 12x6	6. 0	0. 151	DYT10935953	 38. 1X9. 53	9. 53	0. 983				
DYT10937000	 25. 4X12. 7		0. 874	DYT10991000	 88. 9X19. 05		4. 589				
DYT10936953	 88. 9X9. 53	9. 53	2. 295	DYT10991000	 88. 9X19. 05		4. 589				
DYT10935953	 38. 1X9. 53	9. 53	0. 983	DYT11141000 FB1251. 6	 125X1. 6		0. 542				
DYT10972318	 63. 5X3. 18	3. 18	0. 547	DYT11138000 FB1501. 6	 150X1. 6		0. 650				
DYF10651000 ME0002930	 12x4	4	0. 129	DYT11194500 BE04586	 60X5	5. 0	0. 798				
DYT10661000 E4020	 20x4	4	0. 216	DYT11195600 BE04587	 80X6	6. 0	1. 280				
DYT10980000	 50. 8X50. 8		6. 993	DYF10546000 ME0005440	 8X8		0. 172				
DYT10979191	 127X19. 05	1. 91	6. 556	DYF10662000 ME0003754	 10x12		0. 324				
DYT10977953	 31. 75X9. 53	9. 53	0. 819	DYF10612000 ME0003122	 40x40		4. 318				
DYT10976953	 25. 4X9. 53	9. 53	0. 655	DYF10546000 ME0005440	 8X8		0. 172				
DYT10975635	 31. 75X6. 35	6. 35	0. 546	DYF10630000 E8006	 10x10		0. 270				
DYT10973953	 127X9. 53	9. 53	3. 278	DYF10639000 ME0003049	 25x12		0. 810				

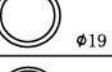
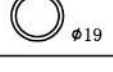
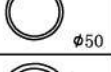

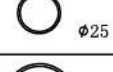

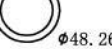













































MẶT CẮT 1 SỐ THANH NHÔM TIÊU BIỂU

ỐNG TRÒN											
DIE #	Sectional cross	Wall Thickness (mm)	Drawing weight (kg/m)	DIE #	Sectional cross	Wall Thickness (mm)	Drawing weight (kg/m)	DIE #	Sectional cross	Wall Thickness (mm)	Drawing weight (kg/m)
ROUND TUBE				ROUND TUBE				ROUND TUBE			
DYC10001060 SY-6311	 Ø8	0.6	0.037	DYC10066142 AA3014	 φ15.88	1.42	0.175	DYC10079258	 φ73.03	5.16	3.001
DYC10002065 SY-6312	 Ø12	0.65	0.063	DYC10067122 AA3015	 φ15.88	1.22	0.152	DYC10082120 E6511	 φ16	1.2	0.151
DYC10008044 NDA YE-11.7	 Ø 11.7	0.44±8%	0.042	DYC10068122 AA3015	 φ15.88	1.22	0.152	DYC10081120 PE00E6509	 φ19	1.2	0.181
DYC10010055 DY-6319	 Ø19	0.55	0.086	DYC10069300 AA3034	 φ25	3.0	0.562	DYC10096160 PE00E6006	 φ40	1.6	0.521
DYC10011110 SD.05	 Ø65	1.1	0.598	DYC10070300 AA3040	 φ32	3.0	0.741	DYC10100142 PE00E6600	 φ15.88	1.42	0.174
DYC10009055 DAB.6319	 Ø19	0.55	0.086	DYC10071325 AA3043	 φ38.1	3.25	0.964	DYC10118200 AA0540	 φ20	20	0.851
DYC10012055 DY6316	 Ø16	0.55	0.072	DYC10074600 AA3106	 φ76	6.0	3.576	DYC10117120 AA530	 φ12	12	0.306
DYC10013055 DY6312	 Ø12	0.55	0.054	DYC10075320 AA3846	 φ44.5	3.2	1.125	DYC10110200 AA3050	 φ50	2	0.817
DYC10014050 DY6311	 Ø8	0.5	0.032	DYC10076090 AA3808	 φ12.7	0.9	0.090	DYC10111160 AA3032	 φ25	1.6	0.319
DYC10020368	 φ48.26	3.68	1.397	DYC10077090 SS5-83001	 φ8	0.9	0.054	DYC10109380 AA3097	 φ76.2	3.8	2.342
DYC10021508	 φ48.26	5.08	1.868	DYC10072300 AA3045	 φ 40	3.0	0.945	DYC10108200 PE00E9004	 φ20	20	0.848
DYC10022355	 φ42.16	3.55	1.167	DYC10073447 AA3048	 φ48.4	4.47	1.672	DYC10110160 PE00E9003	 φ16	16	0.543
DYC10023338	 φ33.4	3.38	0.864	DYC10129070 DL-A030	 φ25	0.7	0.145	DYC10109250 PE00E9005	 φ25	25	1.325
DYC10024391	 φ60.32	3.91	1.878	DYC10127060 DL-A028	 φ19	0.6	0.094	DYC10111100 PE00E9001	 φ10	10	0.212
DYC10025549	 φ88.9	5.49	3.899	DYC10128062 DL-A029	 φ22	0.62	0.113	DYC10112120 PE00E9002	 φ12	12	0.305
DYC10026655	 φ141.3	6.55	7.514	DYC10080160 AA3017	 φ16	1.6	0.196	DYC10104200 PM00081	 φ20	2	0.305
DYC10020368	 φ48.26	3.68	1.397	DYC10078301	 φ114.3	6.02	5.59	DYC10090120 PE00E6003	 φ20	1.6	0.25



















































MẶT CẮT 1 SỐ THANH NHÔM TIÊU BIỂU

ỐNG TRÒN											
DIE #	Sectional cross	Wall Thickness (mm)	Drawing weight (kg/m)	DIE #	Sectional cross	Wall Thickness (mm)	Drawing weight (kg/m)	DIE #	Sectional cross	Wall Thickness (mm)	Drawing weight (kg/m)
ROUND TUBE				ROUND TUBE				ROUND TUBE			
DYC10116120 AL9300		1.2	0.166	DYC10114135 CA0000862		1.35	0.166	DYC10088305 41740000120		3.05	2.576
DYG10768000 420032		6.02	5.554	DYC10143447 ME0000015		4.47	1.666	DYC10089305 41720000120		3.05	1.248
DYC10114300 PE00E6016		3	2.468	DYC10141150 PE00E6582		1.5	1.005	DYC10087318 41760000125		3.18	4.021
DYC10115100 PE00E6017		1	0.093	DYC10142160 PE00E6565		1.6	1.334	DYC10086165 4170500065		1.65	0.156
DYC10098300 PE00E6008		3	0.432	DYC10136325 PE00E6606		3.25	0.96	DYC10085305 41712500120		3.05	0.744
DYC10099200 PE00E6013		2	0.984	DYC10131150 PE00E6520		1.5	0.184	DYC10084305 4171000120		3.05	0.577
DYC10101160 PE00E6004		1.6	0.317	DYC10133160 ME0003160		1.6	0.114	DYC10083165 41710000065		1.65	0.336
DYC10102300 PE00E6009		3	0.56	DYC10132100 ME00003178		1	0.045	DYC10119368 420012		3.68	1.408
DYC10103300 PE00E6014		3	1.45	DYG10771000 30212			0.769	DYC10120318 4173000125		3.18	1.988
DYC10105160 PE00E6005		1.6	0.412	DYG10772000 30208			0.346	DYC10121391 420016		3.91	1.891
DYC10106300 PE00E6010		3	0.738	DYC10122300 ME0002355		3.0	4.448	DYC10145195 ME00C5216		1.95	0.312
DYC10107120 PE00E6506		1.2	0.149	DYC10123240 ME0002354		2.4	3.053	DYC11056320 ME0000012		3.2	0.429
DYC10090120 PE00E6003		1.6	0.25	DYG1078000 302325			0.146	DYC11057160 ME0005053		1.6	0.195
DYC10092160 PE00E6002		1.6	0.195	DYG10779000 30216			1.383	DYC10149120 AA3813		1.2	0.182
DYC10093200 PE00E6007		2	0.814	DYC10125160 PE00E6503		1.6	0.236	DYC10150160 AA3837		1.6	0.237
DYC10094300 PE00E6012		3	1.196	DYC10112549 420024		5.49	3.881	DYC11082120 PE00E6510		1.2	0.242
DYC10097160 PE00E6011		3	0.941	DYC10113508 421012		5.08	1.861	DYC11081300 PE00E6015		3	1.96













































MẶT CẮT 1 SỐ THANH NHÔM TIÊU BIỂU

ỐNG TRÒN											
DIE #	Sectional cross	Wall Thickness (mm)	Drawing weight (kg/m)	DIE #	Sectional cross	Wall Thickness (mm)	Drawing weight (kg/m)	DIE #	Sectional cross	Wall Thickness (mm)	Drawing weight (kg/m)
ROUND TUBE											
DYC11054125		1.25	0.273	DYC11188725		7.25	3.888	DYC11190120		1.2	0.506
DYC11053078		0.79	0.165	DYC11179112		11.25	4.686	DYC11189280		2.80	1.083
DYC10146124		1.24	0.324	DYC11178122		12.25	5.94	DYC11176200		2.0	2.087
DYC10147079		0.79	0.187	DYC11183117		11.75	6.25	DYC11165516		5.16	2.971
DYC10151079		0.79	0.208	DYC11211102		1.015	0.252	DYC11151089		0.89	0.041
DYC11084311		3.11	1.258	DYG11212165		1.65	0.786	DYC11152089		0.89	0.065
DYC11070270 A118		2.7	1.05	DYC11115701		7.01	3.940	DYC11153089		0.89	0.089
DYC11073300 WE0000948		3.0	3.741	DYC11136165		1.65	0.512	DYC11154089		0.89	0.113
DYC10012055 DY6316		0.55	0.072	DYC11127160		1.6	0.575	DYC11148200		2.0	1.162
DYC10013055 DY6312		0.55	0.054	DYC11125142		1.42	0.251	DYC11162142		1.42	0.136
DYC10014050 DY6311		0.5	0.032	DYC11130120		1.2	0.090	DYC11161142		1.42	0.212
DYC11085300 FA0000817		3.0	3.155	DYC11071100		1.0	0.18	DYC11466500		5.0	2.341
DYC11099554		5.54	2.583	DYC11131142		1.42	0.327	DYC11369165		1.65	0.602
DYC11107160 SD-42		1.6	0.557	DYC11124300		3.0	5.094	DYC11368229		2.29	0.738
DYC1184700		7.0	2.991	DYC11123160		1.6	0.657	DYC11155325		3.25	1.136
DYC11180675		6.75	2.206	DYC11118142		1.42	0.289	DYC11146120		1.2	0.246
DYC11109120 ME0003437		1.2	0.314	DYC11128280		2.8	2.950	DYC11141400		4.0	1.561













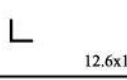

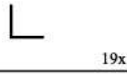
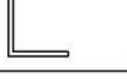

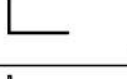

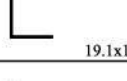

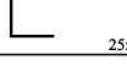
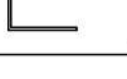

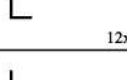

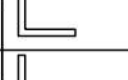
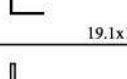

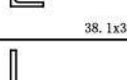



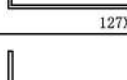

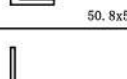

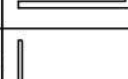
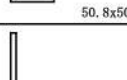
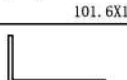

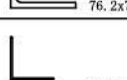
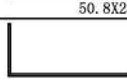
MẶT CẮT 1 SỐ THANH NHÔM TIÊU BIỂU

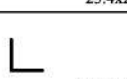
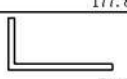
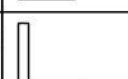
ỐNG TRÒN											
MÃ SỐ	MẶT CẮT	ĐỘ DÀY (mm)	TRỌNG LƯỢNG (kg/m)	MÃ SỐ	MẶT CẮT	ĐỘ DÀY (mm)	TRỌNG LƯỢNG (kg/m)	MÃ SỐ	MẶT CẮT	ĐỘ DÀY (mm)	TRỌNG LƯỢNG (kg/m)
DYC11139470 E2273		4.7	2.847	DYC11237160 ME0002		1.60	0.630	DYC11235109 05308		1.07	0.163
DYC11138200 E6581		2.0	1.323	DYC11238260 ME06130		2.60	1.010	DYC11260110 RT31.751.1		1.10	0.286
DYC11137635 P1000037		6.35	3.078	DYC11229600 RT506.0		6.00	2.239	DYC11266100		10.0	6.432
DYC11140300 BE0002495		3.0	3.741	DYC11445274 EPN-0578		2.74	1.414	DYC11267800		8.0	3.911
DYC11451391		3.91	0.758	DYC11228635 RT6.26.35		6.35	3.762	DYC11272635 ME00795		6.35	5.130
DYC11129330 ME6014		3.3	0.442	DYC11226000 ME0003368		0.159		DYC11298300 059E09260		3	1.047
DYC11214135 ALMC40-1		13.5	5.384	DYC11227200 RT1002.0		2.00	1.663	DYC11299100 059E08390		1	0.230
DYC11219130 ALMC65-3		13	8.585	DYC11239090 ME0003692		0.90	0.053	DYC11300160 022E31211		1.60	0.396
DYC11217175 ALMC65-1		17.5	11.181	DYG11265097 E14034-RO		0.97	0.082	DYC11297400 059K81340		4	1.635
DYC11216120 ALMC50-2		12	7.307	DYC11254000 SE0003060		3.5	2.301	DYC11301450 A5AW7202-01C		4.5	2.203
DYC11215153 ALMC50-1		15.25	7.815	DYC11253000 SE0003129		3.73	1.557	DYC11319318 A21256061T6AC		3.18	1.288
DYC11218140 ALMC65-2		14	10.446	DYC11245000 ME0005191		(9.75)	1.675	DYC11294127 3855		1.27	0.109
DYC11224225		2.25	1.162	DYC11290325 RT76.23.25		3.25	2.011	DYC11494400 RT604.0		4.0	1.907
DYC11223275		2.75	1.739	DYC11317000			0.276	DYC11342287		2.87	0.582
DYC11097160 WE0002056		1.60	1.126	DYC11323574		5.74	4.685	DYC11346165		1.65	0.423
DYC11098160 WE0002055		1.60	1.397	DYC11324277		2.77	0.438	DYC11347318		3.18	0.601
DYC11286120 RT201.2		1.2	0.191	DYC11236089 SH-006144		0.89	0.089	DYC11348373		3.73	0.560

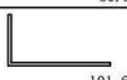
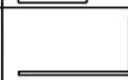

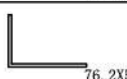













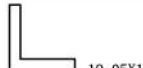

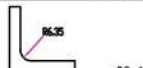



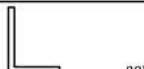



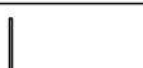

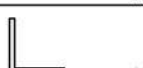

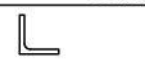



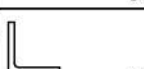

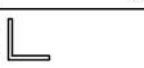
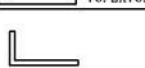
MẶT CẮT 1 SỐ THANH NHÔM TIÊU BIỂU

ỐNG TRÒN											
MÃ SỐ	MẶT CẮT	ĐỘ DÀY (mm)	TRỌNG LƯỢNG (kg/m)	MÃ SỐ	MẶT CẮT	ĐỘ DÀY (mm)	TRỌNG LƯỢNG (kg/m)	MÃ SỐ	MẶT CẮT	ĐỘ DÀY (mm)	TRỌNG LƯỢNG (kg/m)
								DYC11355000	 $\phi 63.5$		8.582
DYC11360318	 $\phi 38.1$	3.18	0.944	DYC11460305	 $\phi 127$	3.18	3.347	DYC11143000 E9080	 $\phi 6$		0.076
DYC11370277	 $\phi 48.26$	2.77	1.072	DYC11461808	 $\phi 101.8$	8.08	6.431	DYC11144000 E9060	 $\phi 8$		0.136
DYC11369165	 $\phi 44.45$	1.65	0.602	DYC11475234 EPN-0579	 $\phi 82.55$	2.34	1.596	DYC11383000	 $\phi 15.88$		0.536
DYC10001060M SY-6311M	 $\phi 8$	0.6	0.038	DYC11385350 BANCO0082-1	 $\phi 16$	3.5	0.372	DYC11382000	 $\phi 12.7$		0.343
DYC10002065M SY-6312M	 $\phi 12$	0.65	0.064	DYC11389178 COMP2515AT-35-STE REV A	 $\phi 38.1$	1.78	0.55	DYC11145000 E9006	 $\phi 32.3$		2.212
DYC10003069M SK-6316M	 $\phi 16$	0.69	0.090	DYC11498160	 $\phi 13.69$	1.6	0.165	DYC11366000	 $\phi 44.45$		4.205
DYC10010064M DY-6319M	 $\phi 19$	0.64	0.100	DYC11368229	 $\phi 40.13$	2.29	0.738	DYC11365000	 $\phi 31.75$		2.146
DYC10128068M DL-A029M	 $\phi 22$	0.68	0.123	DYC11384762	 $\phi 88.9$	7.62	5.273	DYC11373000	 $\phi 9.53$		0.193
DYC10129068M DL-A030M	 $\phi 25$	0.68	0.141	DYC11472129 RT51.6113.21	 $\phi 51.61$	13.21	4.318	DYC11366000	 $\phi 44.45$		4.205
				DYC11370277	 $\phi 48.26$	2.77	1.072	DYC11365000	 $\phi 31.75$		2.146
				DYC11369165	 $\phi 44.45$	1.65	0.602	DYT10885000	 $\phi 22.23$		1.051
				DYC11372165	 $\phi 50.8$	1.65	0.691	DYC11366000	 $\phi 44.45$		4.205
				DYC11380318	 $\phi 31.75$	3.18	0.772	DYC11365000	 $\phi 31.75$		2.146
				DYC11376635	 $\phi 50.8$	6.35	2.403	DYC11126000 E9011	 $\phi 39$		3.225
				DYC11378455	 $\phi 33.4$	4.55	1.117	DYC11225000 RB50.8	 $\phi 50.8$		5.472
				DYC11377231	 $\phi 17.15$	2.31	0.292	DYC11450000	 $\phi 34.93$		2.596
				DYC11375165	 $\phi 19.05$	1.65	0.244	DYC11349000	 $\phi 38.1$		3.090

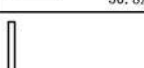
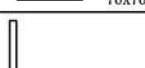
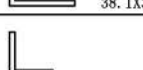
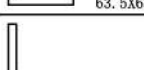

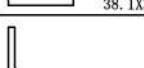

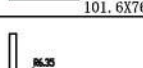

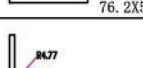
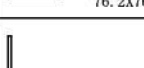
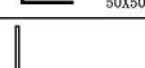

















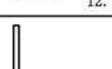











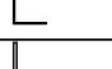
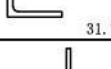

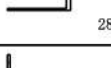





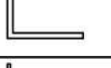

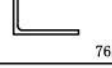

MẶT CẮT 1 SỐ THANH NHÔM TIÊU BIỂU

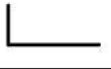
THANH L											
DIE #	Sectional cross	Wall Thickness (mm)	Drawing weight (kg/m)	DIE #	Sectional cross	Wall Thickness (mm)	Drawing weight (kg/m)	DIE #	Sectional cross	Wall Thickness (mm)	Drawing weight (kg/m)
DYT10008060 YE-10x10	 10x10	0.6±8%	0.031	DYG10549300 AA1030	 40X40	3.0	0.626	DYT10293160	 20X20	1.6	0.166
DYT10009060 YE-12.6x12.6	 12.6x12.6	0.6±8%	0.04	DYT10174157 TC042	 50. 8X25. 4	1.57	0.319	DYT10289600 AA1700	 100X50	6	2.341
DYT10010060 YE-19x19	 19x19	0.6±8%	0.061	DYF10171400 AA1038	 50X50	4	1.04	DYT10252600 PEOE10017	 40X40	6	1.198
DYT10036065 SK-6201	 12x12	0.65	0.041	DYT10203150 PEOE10024	 70X40	1.5	0.439	DYT10261600 PEOE10020	 100X100	6	3.14
DYT10037065 SK-6202	 19.1x19.1	0.65	0.066	DYF10204160 WE0000384	 35X35	1.6	0.295	DYT10262160 PEOE10002	 20X12	1.6	0.131
DYT10038060 SK-6203	 25x25	0.6	0.08	DYT10253160 PEOE10022	 40X20	1.6	0.252	DYT10263160 PEOE10007	 32X20	1.6	0.217
DYT10068055 DY6201	 12x12	0.55	0.034	DYT10249160 E2431	 70X25	1.6	0.403	DYT10264300 PEOE10013	 25X25	3	0.38
DYT10069055 DY6202	 19.1x19.1	0.55	0.056	DYT10266160 PEOE10023	 50X25	1.6	0.317	DYT10265600 PEOE10018	 50X50	6	1.522
DYG10074476	 38. 1x38. 1	4.76	0.934	DYT10271300 PEOE10027	 50X25	3	0.583	DYT10250160 PEOE10006	 25X25	1.6	0.209
DYG10075635	 63. 5x63. 5	6.35	2.099	DYT10188305 AXXX-251820	 127X50	3.05	1.443	DYT10251300 PEOE10012	 20X25	3	0.34
DYG10076635	 50. 8x50. 8	6.35	1.662	DYT10334635 AA1074	 76. 2X76. 2	6.35	2.547	DYT10254600 PEOE10071	 100X50	6	2.332
DYG10077476	 50. 8x50. 8	4.76	1.262	DYT10333635 AA1145	 101. 6X101. 6	6.35	3.44	DYT10255160 PEOE10005	 25X20	1.6	0.187
DYG10078635	 76. 2x76. 2	6.35	2.536	DYT10183223 AXXX-129320	 50. 8X25. 4	2.23	0.446	DYT10256160 PEOE10010	 50X50	1.6	0.425
DYG10248090 (XS67753)	 25.4x25.4	0.9	0.124	DYT10189305 AXXX-371820	 177. 8X76. 2	3.05	2.072	DYT10257300 PEOE10016	 50X50	3	0.785
DYG10249090 (XS67754)	 19.05x19.05	0.9	0.09	DYT10182305 AXXX-121820	 50. 8X25. 4	3.05	0.603	DYT10258300 PEOE10021	 20X20	3	0.299
DYG10550300 AA1036	 50x50	3.0	0.789	DYT10187305 AXXX-241820	 101. 6X50. 8	3.05	1.233	DYT10259300 PEOE10070	 100X50	3	1.19
DYG10551600 AA1037	 50x50	6.0	1.528	DYT10186305 AXXX-231820	 76. 2X50. 8	3.05	1.023	DYT10260300 PEOE10015	 40X40	3	0.623



















































MẶT CẮT 1 SỐ THANH NHÔM TIÊU BIỂU

THANH L											
DIE #	Sectional cross	Wall Thickness (mm)	Drawing weight (kg/m)	DIE #	Sectional cross	Wall Thickness (mm)	Drawing weight (kg/m)	DIE #	Sectional cross	Wall Thickness (mm)	Drawing weight (kg/m)
DYT10236953 384061212	 76. 2X76. 2	9. 53	3. 768	DYF10347600 ME0002931	 60X60	6	1. 846	DYT10420390 SY-4494	 31. 75X31. 75	3. 9	0. 585
DYT10237318 3840212086063	 50. 8X76. 2	3. 18	1. 059	DYT10357160 EE1000001	 32X32	1. 6	0. 269	DYT10378160 AA1008	 25X25	1. 6	0. 209
DYT10238318 3830203036063	 19. 05X19. 05	3. 18	0. 299	DYT10362160 E10029	 15X15	1. 6	0. 123	DYT10379160 AA1034	 50X50	1. 6	0. 426
DYT10241635 383040606	 38. 1X38. 1	6. 35	1. 22	DYT10363400 PEOE10026	 50X50	4. 0	1. 04	DYT10380160 AA1020	 32X32	1. 5	0. 254
DYT10243318 3830208086063	 50. 8X50. 8	3. 18	0. 846	DYT10364300 ME0000168	 32X25	3. 0	0. 439	DYT10377160 AA1027	 40X40	1. 6	0. 34
DYT10267160 PEOE10003	 20X20	1. 6	0. 166	DYT10361600 AA1032	 40X40	6	1. 203	DYT10409300 ME0002242	 50X20	3. 0	0. 542
DYT10268160 PEOE10008	 25X25	1. 6	0. 274	DYT10360300 AA1010	 25X25	3	0. 382	DYT10394635 PEOE2494	 63. 5X63. 5	6. 35	2. 096
DYT10269300 PEOE10014	 32X32	3	0. 494	DYT10353150 SS6-81587	 21. 5X1. 5	1. 5	0. 167	DYT10393475 PEOE2493	 38. 1X38. 1	4. 75	0. 934
DYT10270600 PEOE10019	 80X80	6	2. 494	DYT10350300 ME0000007	 40X25	3. 0	0. 502	DYT10395635 PEOE2495	 50. 8X76. 2	6. 35	2. 096
DYT10272160 PEOE10004	 25X12	1. 6	0. 153	DYT10342600 AA1039	 50X50	6	1. 538	DYT10396635 PEOE2496	 76. 2X76. 2	6. 35	2. 538
DYT10273160 PEOE10009	 40X40	1. 6		DYT10341400 AA1031	 40X40	4	0. 824	DYT10385300 ME0002933	 40X20	3	0. 461
DYT10274100 PEOE10041	 80X80	10	4. 05	DYT10327635 AA1045	 50. 8X50. 8	6. 35	1. 661	DYT10344300 ME0003115	 76X76	3	1. 206
DYT10244318 3830206066063	 38. 1X38. 1	3. 18	0. 624	DYT10329635 AA1065	 63. 5X63. 5	6. 35	2. 104	DYT10346400 ME0002964	 40X40	4	0. 82
DYT10246318 3830204046063	 25. 4X25. 4	3. 18	0. 407	DYT10326475 AA1026	 38. 1X38. 1	4. 75	0. 936	DYT10360160 PEOE10001	 12X12	1. 6	0. 096
DYT10248635 384041612	 101. 6X76. 2	6. 35	2. 963	DYT10345635 383040808	 50. 8X50. 8	6. 35	1. 675	DYT10372300 EE1000002	 12X12	3	0. 17
DYT10340635 384041208	 76. 2X50. 8	6. 35	2. 115	DYT10344635 384041212	 76. 2X76. 2	6. 35	2. 555	DYT10358150 BE0000985	 50X50	1. 5	0. 399
DYT10338477 383030808	 50. 8X50. 8	4. 77	1. 274	DYT10339318 383020606	 38. 1X38. 1	3. 18	0. 639	DYT10343300 ME0003196	 60X60	3	0. 947

















































MẶT CẮT 1 SỐ THANH NHÔM TIÊU BIỂU

THANH L											
DIE #	Sectional cross	Wall Thickness (mm)	Drawing weight (kg/m)	DIE #	Sectional cross	Wall Thickness (mm)	Drawing weight (kg/m)	DIE #	Sectional cross	Wall Thickness (mm)	Drawing weight (kg/m)
DYT10473460 A146L	 101.6X50.8	4.6	1.856	DYT10603160 E10072	 50x20	1.6	0.296	DYT10007070 YE-007	 23.6x23.6	0.7±8%	0.088
DYT10481200	 38x19	2.0	0.298	DYT10601450 SE0002759	 63.5x25	4.5	1.020	DYT10173124	 24x38.1	1.24	0.205
DYT10456600 A137	 101X76	6	2.78	DYT10599160 E10025	 70X20	1.6	0.382	DYT10172115 SS6S07359	 36.5X36.5	1.15	0.248
DYT10426160 ME0005057	 20X20	1.6	0.166	DYT10616150 ME0004325	 48x33.4		0.321	DYT10277160 PE00E7001	 25X25	1.6	0.209
DYT10299159 IE1209	 12.7X12.7	1.59	0.103	DYT10628635 E2486	 101.6x48	6.35	2.527	DYT10280300 PE00E7002	 40X40	3	0.623
DYT10300159 IE1213	 19.05X19.05	1.59	0.158	DYT10613400 WEA11	 100x50	4.0	1.577	DYT10368160 ME0003108	 20X20	1.6	0.166
DYT10301159 IE1215	 25.4X25.4	1.59	0.213	DYT10944635	 50.8X50.8	6.35	1.686	DYT10453160 ME0000330	 40X40	1.6	0.34
DYT10068055 DY6201	 12x12	0.55	0.034	DYT10613400 WEA11	 100x50	4.0	1.577	DYT10489150 CR0000021	 40X40	1.5	0.316
DYT10069055 DY6202	 19.1x19.1	0.55	0.056	DYT10974318	 31.75X31.75	3.18	0.525	DYT10666300 CA0000891	 30x20	3.0	0.380
DYT10499300 TC163	 101.6X50.8	3.0	1.214	DYT10691000 ME0005024	 28.6X44		0.397	DYT10557300 SE0003033	 25x25	3.0	0.379
DYT10487300 TC045	 50.8X50.8	3.0	0.797	DYT10683180 CR0000054	 50x50	1.8	0.474	DYT10625300 E7003	 50x50		0.786
DYT10486150 TC127	 76.2X50.8	1.5	0.405	DYT10679000 FA0788	 19.5x12		0.114	DYT10591300 ME0003109	 20x20	3.0	0.3
DYT10492476	 76.2X50.8	4.76	1.602	DYT10665150 FA0916	 40x40	1.5	0.318	DYT10544300 EE7000001	 25x25	3.0	0.381
DYT10491318	 25.4X25.4	3.18	0.419	DYT10551160 CR0000037	 90x40	1.6	0.553	DYT10566140 PM0000148	 40x12	1.4	0.191
DYT10501635 SA-0982	 76.2X50.5	6.35	2.086	DYT10525600 WE0001052	 125x50	6.0	2.737	DYT10541300 SE0003118	 40x25	3.0	0.502
DYT10501635 SA-0982	 76.2X50.8	6.35	2.091	DYT10527150 CR0000020	 40x40	1.5	0.316	DYT10542300 SE0003120	 40x40	3.0	0.623
DYT10488635	 101.6X101.6	6.35	3.436	DYT10529200 ME0002951	 35x35	2.0	0.367	DYT10559400 SE0003136	 190x32	4.0	2.354































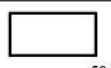
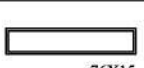













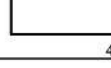

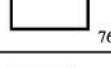

MẶT CÁT 1 SỐ THANH NHÔM TIÊU BIỂU

THANH L											
MÃ SỐ	MẶT CÁT	ĐỘ DÀY (mm)	TRỌNG LÝNG (kg/m)	MÃ SỐ	MẶT CÁT	ĐỘ DÀY (mm)	TRỌNG LÝNG (kg/m)	MÃ SỐ	MẶT CÁT	ĐỘ DÀY (mm)	TRỌNG LÝNG (kg/m)
DYG10078635	 76. 2x76. 2	6. 35	2. 536	DYG10076635	 50. 8x50. 8	6. 35	1. 662	DYT10510318	 50. 8X50. 8	3. 18	0. 854
DYT10334635 AA1074	 76. 2X76. 2	6. 35	2. 547	DYG10077476	 50. 8x50. 8	4. 76	1. 262	DYT10511478	 76. 2X76. 2	4. 78	1. 924
DYT10236953 384061212	 76. 2X76. 2	9. 53	3. 768	DYG10550300 AA1036	 50x50	3. 0	0. 789	DYT10989635	 50. 8X50. 8	6. 35	1. 639
DYT10344635 384041212	 76. 2X76. 2	6. 35	2. 555	DYG10551600 AA1037	 50x50	6. 0	1. 528	DYT10989635	 50. 8X50. 8	6. 35	1. 639
DYT10396635 PE00E2496	 76. 2X76. 2	6. 35	2. 538	DYF10171400 AA1038	 50X50	4	1. 04	DYT10954159	 38. 1X38. 1	1. 59	0. 321
DYT10344300 ME0003115	 76X76	3	1. 206	DYT10265600 PE0E10018	 50X50	6	1. 522	DYT10953953	 76. 2X50. 8	9. 53	3. 042
DYT10587000 E2497	 76.2x76.2		3. 710	DYT10256160 PE0E10010	 50X50	1. 6	0. 425	DYT10964635 0	 25. 4X25. 4	6. 35	0. 788
DYT10571635 E2498	 50. 8x50. 8	6. 35	1. 655	DYT10257300 PE0E10016	 50X50	3	0. 785	DYT11045318 25055	 25. 4X25. 4	3. 18	0. 410
DYT10987200	 128. 59X128. 59	2. 0	1. 383	DYT10243318 3830208086063	 50. 8X50. 8	3. 18	0. 846	DYT11116635	 152. 4X76. 2	6. 35	3. 824
DYT10995476	 25. 4X25. 4	4. 76	0. 607	DYT10338477 383030808	 50. 8X50. 8	4. 77	1. 274	DYT11137318	 38. 1X25. 4	3. 18	0. 519
DYT10996953	 101. 6X76. 2	9. 53	4. 396	DYT10363400 PE0E10026	 50X50	4. 0	1. 04	DYT11109127 4018	 12. 7X9. 53	1. 27	0. 072
DYT11182160 AN40121. 6	 40X12	1. 6	0. 219	DYT10342600 AA1039	 50X50	6	1. 538	DYT11190635	 31. 75X31. 75	6. 35	0. 989
DYT10747476	 50.8x63.5	4.76	1.427	DYT10327635 AA1045	 50. 8X50. 8	6. 35	1. 661	DYT11205102 ND0270	 19. 05X19. 05	0. 97	0. 097
DYT10748476	 50.8x38.1	4.76	1.099	DYT10345635 383040808	 50. 8X50. 8	6. 35	1. 675	DYT11208114 ND0285	 38. 1X25. 4	1. 02	0. 172
DYT10639476	 50. 8x50. 8	4. 76	1. 250	DYT10358150 BE0000985	 50X50	1. 5	0. 399	DYT11207140-rev1 ND0290-rev1	 31. 75X19. 05	1. 4	0. 187
DYT10875953 GVA-D01126	 50. 8X50. 8	9. 53	2. 429	DYT10487300 TC045	 50. 8X50. 8	3. 0	0. 797	DYT10940635	 50. 8X50. 8	6. 35	1. 651
DYT11158500 AN75505. 0	 75X50	5. 0	1. 626	DYT10714224 TC043	 50. 8x50. 8	2. 24	0. 607	DYT10963318	 19. 05X19. 05	3. 18	0. 306















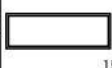

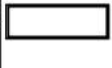

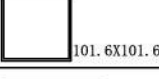



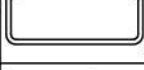















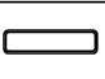

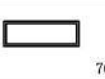

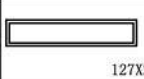

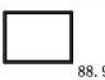

MẶT CẮT 1 SỐ THANH NHÔM TIÊU BIỂU

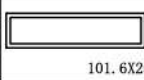
THANH L											
MÃ SỐ	MẶT CẮT	ĐỘ DÀY (mm)	TRỌNG LƯỢNG (kg/m)	MÃ SỐ	MẶT CẮT	ĐỘ DÀY (mm)	TRỌNG LƯỢNG (kg/m)	MÃ SỐ	MẶT CẮT	ĐỘ DÀY (mm)	TRỌNG LƯỢNG (kg/m)
DYT10875953 GVA-D01126	 50. 8X50. 8	9. 53	2. 429	DYT10587000 E2497	 76.2X76.2		3. 710	DYT10940635	 50. 8X50. 8	6. 35	1. 651
DYT10847157	 15. 88X38. 1	1. 57	0. 223	DYT10595300 E10011	 12x25	3. 0	0. 275	DYT10940635	 50. 8X50. 8	6. 35	1. 651
DYT10881318	 76. 2X25. 4	3. 18	0. 847	DYT10541600 BE0002351	 80x50	6. 0	2. 018	DYT10716236 BE0000120	 110X38	2. 36	0. 921
DYT10880476	 50. 8X25. 4	4. 76	0. 922	DYT10594300 ME0003246	 16x6	3. 0	0. 234	DYT10778300 BE0002669	 100X76. 2	3. 0	1. 403
DYT10928198 PART#1068	 25. 4X50. 8	1. 98	0. 396	DYT10593300 ME0003116	 80x20	3. 0	0. 785	DYT10711160 EE1000900	 115x40	1. 60	0. 662
DYT10929239 PART#1069	 19. 5X50. 8	2. 39	0. 433	DYT10592000 ME0003114	 25x25		0. 712	DYT10701300 ME0019	 40X12	3. 0	0. 397
DYT11112476	 31. 75X31. 75	4. 76	0. 758	DYT10639476	 50. 8x50. 8	4. 76	1. 250	DYT10704300 AN50403. 0	 50x40	3. 00	0. 704
DYT10814318 96A	 76. 2X38. 1	3. 18	0. 956	DYT10589300 ME0002932	 50x12	3. 0	0. 478	DYT10699600 AN80406. 0	 80X40	6. 00	1. 847
DYT11176500 AE-15	 50X50	5. 0	1. 287	DYT10588000 ME0002634	 90x40		0. 520	DYT10697300 AN65253. 0	 65X25	3. 00	0. 705
DYT10995476	 25. 4X25. 4	4. 76	0. 607	DYT10564300 ME0002635	 125x0	3. 0	1. 398	DYT10718318 CM101-1	 635x1905	3. 18	0. 683
DYT11207140 ND0290	 31. 75X19. 05	1. 4	0. 187	DYT10562300 ME0018	 32x20	3. 0	0. 397	DYT10709300 DA-CW07	 30X20	3. 0	0. 381
DYT11188145 NH2069	 81. 28X41. 4	1. 45	0. 492	DYT10627300 E10033	 20x12	3. 0	0. 235	DYT10754478	 38.1x38.1	4. 78	0. 924
DYT11189152 NH2070	 44. 45X44. 45	1. 45	0. 36	DYT10561140 E10000	 20x10	1. 40	0. 108	DYT10747476	 50.8x63.5	4. 76	1. 427
DYT10996953	 101. 6X76. 2	9. 53	4. 396	DYT10780230 ME00597	 38X20	2. 3	0. 346	DYT10748476	 50.8x38.1	4. 76	1. 099
DYT10069066M DY-6202M	 19. 1X19. 1	0. 66	0. 067	DYT10570300 ME0003057	 60x25	3. 0	0. 664	DYT10776212	 25. 4x50. 8	2. 12	0. 425
DYT10068064M DY6201M	 12X12	0. 64	0. 040	DYT10571635 E2498	 50. 8x50. 8	6. 35	1. 655				
DYT10038067M SK-6203M	 25X25	0. 67	0. 089	DYT10714224 TC043	 50. 8x50. 8	2. 24	0. 607				

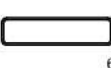
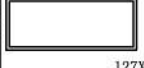

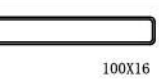
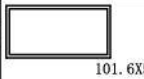















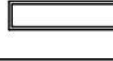











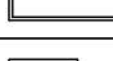



















MẶT CẮT 1 SỐ THANH NHÔM TIÊU BIỂU

HÀNG HỘP											
DIE #	Sectional cross	Wall Thickness (mm)	Drawing weight (kg/m)	DIE #	Sectional cross	Wall Thickness (mm)	Drawing weight (kg/m)	DIE #	Sectional cross	Wall Thickness (mm)	Drawing weight (kg/m)
Rectangular bar				Rectangular bar				Rectangular bar			
DYF10001050 YE-20x10	 20x10	0.5±8%	0.08	DYF10023060 SK-6105	 20x12	0.6±8%	0.1	DYF10048127	 19.5x19.5	1.27	0.201
DYF10002050 YE-25x12	 25x12	0.5±8%	0.1	DYF10024060 SK-6108	 25x12	0.6±8%	0.116	DYF10049305	 38.1x38.1	3.05	1.067
DYF10003100 YE-20x20	 20x20	1.0±8%	0.206	DYF10025050 NDA YE-25x25B	 25x25	0.5±8%	0.132	DYF10050477	 38.1x38.1	4.77	1.671
DYF10004060 YE-25x25	 25x25	0.6±8%	0.16	DYF10026050 NDA YE-25x12	 25x12	0.5±8%	0.097	DYF10051318	 31.75x31.75	3.18	0.985
DYF10006100 YE-30x30	 30x30	1.0±8%	0.314	DYF10027050 NDA YE-20x12	 20x12	0.5±8%	0.084	DYF10052305	 25.4x25.4	3.05	0.739
DYF10007060 YE-38x25	 38x25	0.6±8%	0.2	DYF10028075 NA.07	 100x43	0.75	0.581	DYF10053305	 50.8x50.8	3.05	1.451
DYF10009060 YE-38x38	 38x38	0.6±8%	0.243	DYF10029075 NA.08	 40x20	0.75	0.238	DYF10054477	 50.8x50.8	4.77	2.222
DYF10010060 YE-50.7x25.3	 50.7x25.3	0.6±8%	0.24	DYF10447140 SD.76X15	 76X15	1.4	0.672	DYF10055477	 101.6x50.8	4.77	3.641
DYF10011060 YE-50x38	 50x38	0.6±8%	0.28	DYF10032060 DY7013	 76X25	0.6	0.324	DYF10056635	 76.2x76.2	6.35	4.691
DYF10013060 YE-76x25	 76x25	0.6±8%	0.32	DYF10033075 DY7004	 76x44	0.75	0.482	DYF10048127	 16.9x15.9	1.27	0.200
DYF10014070 YE-76.3x38.3	 76.3x38.3	0.7±8%	0.43	DYF10034055 DY6102	 38x25	0.55	0.184	DYF10057127	 38.1x15.87	1.27	0.353
DYF10016070 YE-76x44	 76x44	0.7±8%	0.45	DYF10035055 DY6103	 50x25	0.55	0.22	DYF10058152	 38.1x38.1	1.524	0.604
DYF10018080 YE-44x100	 44x100	0.8±8%	0.617	DYF10036050 DY6105	 20x12	0.5	0.084	DYF10059240	 50.8x50.8	2.4	1.259
DYF10019110 DN-7004	 76x44.4	1.0~1.1	0.704	DYF10037055 DY6125	 25x25	0.55	0.145	DYF10085185 AA4124	 50.8x50.8	1.85	0.935
DYF10020060 SK-6102	 38x25	0.6±8%	0.2	DYF10038050 DY6108	 25X12	0.5	0.097	DYF10094160 AA4036	 25x25	1.6	0.406
DYF10021060 SK-6103	 50x25	0.6±8%	0.24	DYF10039060 DY6138	 38X38	0.6	0.243	DYF10095300 AA4046	 25x25	3.0	0.715
DYF10022060 SK-6125	 25x25	0.6±8%	0.158	DYF10060200	 63.5x63.5	2.0	1.315	DYF10096300 AA4100	 40x40	3.0	1.203



















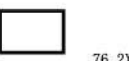

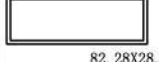









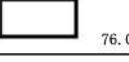

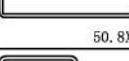









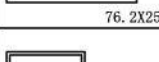



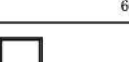

MẶT CẮT 1 SỐ THANH NHÔM TIÊU BIỂU

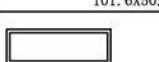
HÀNG HỘP											
DIE #	Sectional cross	Wall Thickness (mm)	Drawing weight (kg/m)	DIE #	Sectional cross	Wall Thickness (mm)	Drawing weight (kg/m)	DIE #	Sectional cross	Wall Thickness (mm)	Drawing weight (kg/m)
Rectangular bar				Rectangular bar				Rectangular bar			
DYF10097250 AA4122	 50x50	2.5	1.287	DYF10224127	 25.4X25.4	1.27	0.334	DYF10167478 4150818CC	 50.8X50.8	4.78	2.386
DYF10099320 AA4130	 50.8x50.8	3.2	1.604	DYF10108224 TC236	 76.2X76.2	2.24	1.809	DYF10168318 4162408126063	 152.4X50.8	3.18	3.269
DYF10101200 AA4125	 50x50	2.0	0.994	DYF10109300 TC244	 76.2X76.2	3.0	2.398	DYG10901300 PE00E3006	 150X50	3	3.143
DYF10103300 AA4150	 65x65	3.0	2.016	DYF10110300 TC245	 101.6X101.6	3.0	3.23	DYF10227250 BE0002060	 65X65	2.5	1.632
DYF10105250 AA4516	 38x25	2.5	0.77	DYF10112223 TC325	 127X50.8	2.23	2.111	DYF10225140 BE0001410	 40X16	1.4	0.387
DYF10106300 AA4640	 100x50	3.0	2.341	DYF10086200 AA1038	 25X25	2	0.493	DYF10226150 BE0001988	 38X25	1.5	0.47
DYF10113090 SS5-82994	 17X17	0.9	0.155	DYF10087300 AA4123	 50X50	3	1.528	DYF10213200 BE0002370	 50X25	2	0.748
DYF10084150 AA4515	 38x25	1.5	0.472	DYF10123318	 50.8x50.8	3.18	1.623	DYF10214122 BE0002352	 25.4X25.4	1.22	0.305
DYF10093120 AA4021	 20X20	1.2	0.245	DYF10122478	 38.1x38.1	4.78	1.738	DYF10215160 BE0002358	 70X70	1.6	1.182
DYF10098300 AA4533	 50X25	3.0	1.101	DYF10120305	 31.75x31.75	3.05	0.938	DYF10228160 AA4620	 100X50	1.6	1.273
DYF10102140 AA4561	 65X16	1.4	0.578	DYF10121318	 38.1x38.1	3.18	1.188	DYF10134305 TBXX-221820	 50.8X50.8	2.46	1.29
DYF10104236 AA4580	 76.2X25.4	2.36	1.239	DYF10127318	 76.2x50.8	3.18	2.092	DYF10131305 TBXX-151820	 127X25.4	3.05	2.416
DYF10100300 AA4530	 50X25	3.0	1.122	DYF10126241	 50.8x25.4	2.41	0.94	DYF10135305 TBXX-231820	 76.2X50.8	2.46	1.629
DYG10473236 CDW-60	 88.9x66.68	2.36	1.93	DYF10125318	 50.8x50.8	3.18	1.651	DYF10130305 TBXX-141820	 101.6X25.4	3.05	1.998
DYF10114051	 15.88X5.84	0.51	0.0562	DYF10152120 ME0050344	 65X16	1.2	0.496	DYF10137305 TBXX-251820	 127X50.8	3.05	2.876
DYF10107060	 15.2X15.2	0.6	0.095	DYF10153140 WE0000451	 100X16	1.4	0.841	DYF10136305 TBXX-241820	 101.6X50.8	3.05	2.417
DYF10223200 AA4096	 40X40	2	0.805	DYF10150300 PE00E3020	 50X50	3.0	1.523	DYG10151300 PM0000046	 50X50	3.0	1.46



















































MẶT CẮT 1 SỐ THANH NHÔM TIÊU BIỂU

HÀNG HỘP											
DIE #	Sectional cross	Wall Thickness (mm)	Drawing weight (kg/m)	DIE #	Sectional cross	Wall Thickness (mm)	Drawing weight (kg/m)	DIE #	Sectional cross	Wall Thickness (mm)	Drawing weight (kg/m)
DYF10211300 PM0000099	 60X40	3.0	1.523	DYF10153318 41504126063	 25.4X25.4	3.18	0.767	DYF10210320 PE00E3051	 38.1X25.4	3.2	0.969
DYF10209240 PE00E3000	 76.2X25.4	2.4	1.254	DYF10169318 41512126063	 76.2X76.2	3.18	2.426	DYF10197300 PE00E3054	 80X40	3	1.847
DYF10206150 PE00E2615	 38X25	1.5	0.47	DYF10170305 41505126063	 31.75X31.75	3.05	0.945	DYF10201250 PE00E3058	 100X25	2.5	1.62
DYF10203220 PE00E2614	 38X25	2.2	0.68	DYF10172635 416120825CC	 76.2X50.8	6.35	3.95	DYF10202160 PM0000144	 50X25	1.6	0.605
DYF10199300 ME0000157	 50X25	3.0	1.118	DYF10173305 4161208126063	 76.2X50.8	3.05	1.989	DYF10204300 PE00E3004	 80X50	3	2.009
DYF10198140 PM000104A	 65X16	1.4	0.576	DYF10154305 41508126063	 50.8X50.8	3.05	1.573	DYF10208300 PM0000045	 100X50	3	2.27
DYF10175180 PE00E2510	 50X50	1.8	0.894	DYF10192200 ME0003002	 25X25	2.0	0.497	DYF10207300 PE00E3005	 100X50	3	2.333
DYF10179160 PE00E2631	 19X19	1.6	0.298	DYF10191160 PE00E3007	 12X12	1.6	0.18	DYF10196250 PE00E3002	 40X25	2.5	0.81
DYF10180160 BE0000603	 25X25	1.6	0.404	DYF10190300 PE00E3016	 20X20	3.0	0.553	DYF10200250 PE00E3003	 50X25	2.5	0.945
DYF10183240 PE00E2176	 40X40	2.4	0.974	DYF10186160 PE00E3011	 25X25	1.6	0.404	DYF10216120 BE0000749	 38X16	1.2	0.321
DYF10184200 PE00E3100	 25X25	2.0	0.5	DYF10185300 PE00E3017	 25X25	3.0	0.713	DYF10218300 BE0002363	 70X30	3	1.494
DYF10187120 PE00E2174	 19.05X19.05	1.2	0.228	DYF10182160 PE00E3012	 32X32	1.6	0.525	DYF10212300 BE0002357	 65X65	3	2.009
DYF10205160 PE00E3501	 100X50	1.6	1.268	DYF10181300 PE00E3018	 32X32	3.0	0.94	DYF10219200 BE0002355	 40X40	3	1.164
DYF10188120 PW003004A	 25.4X25.4	1.2	0.314	DYF10178200 PE0000079	 50X50	2.0	0.99	DYF10222300 BE0002367	 50X25	3	1.097
DYF1195160 PE00E3015	 50X50	1.6	0.836	DYF10177300 PE00E3019	 40X40	3.0	1.199	DYF10221500 BE0002356	 50X50	5	2.349
DYF10194300 PE00E3021	 75X75	3	2.333	DYF1176160 PE00E3014	 40X40	1.6	0.663	DYF10220300 BE0002364	 80X50	3	1.946
DYF10193200 PM0000115	 40X40	2	0.795	DYF10174300 PM00047	 40X40	3.0	1.136	DYF10217200 BE0002354	 40X40	2	0.802



















































MẶT CẮT 1 SỐ THANH NHÔM TIÊU BIỂU

HÀNG HỘP											
DIE #	Sectional cross	Wall Thickness (mm)	Drawing weight (kg/m)	DIE #	Sectional cross	Wall Thickness (mm)	Drawing weight (kg/m)	DIE #	Sectional cross	Wall Thickness (mm)	Drawing weight (kg/m)
Rectangular bar				Rectangular bar				Rectangular bar			
DYF10259635 AA4190	 76. 2X76. 2	6. 35	4. 432	DYF10281140 CA0000912	 35X25	1. 4	0. 419	DYF10410140 CA0001479	 80X16	1. 4	0. 69
DYF10260200 AA4095	 40X40	2. 0	0. 824	DYF10282140 CA0000621	 25X25	1. 4	0. 343	DYF10406200 SY-343	 101X101	2. 0	2. 138
DYF10261600 ME0003298	 101. 6X50. 8	6	4. 41	DYF10283140 CA0000616	 35X35	1. 4	0. 495	DYF10407195 SY-335	 76. 2X50. 8	1. 95	1. 3
DYF10246477 416160818CC	 101. 6X50. 8	4. 77	3. 721	DYF10294220 ME0003120	 82. 28X28. 58	2. 2	1. 265	DYF10432240 A012	 38. 1X38. 1	2. 4	0. 932
DYF10247635 4151225	 76. 2X76. 2	6. 35	4. 773	DYF10295150 ME0003119	 76X25	1. 5	0. 794	DYF10414192 SY-3147	 50. 65X50. 65	1. 92	1. 014
DYF10243318 416080412	 50. 8X25. 4	3. 18	1. 14	DYF10284120 CA0000615	 20X20	1. 2	0. 231	DYF10413317 SY-311	 38. 1X38. 1	3. 17	1. 2
DYF10250305 4150412	 25. 4X25. 4	3. 05	0. 709	DYF10292160 BE0000984	 50X50	1. 6	0. 798	DYF10412192 SY-3325	 76. 05X38	1. 92	1. 147
DYF10248477 4150618	 38. 1X38. 1	4. 77	1. 696	DYF10362100 SE0000490	 50X10	1	0. 309	DYF10402130 PE00E2708	 50. 8X11. 1	1. 3	0. 407
DYF10242305 4150512	 31. 75X31. 75	3. 05	0. 908	DYF10278300 AA4045	 25X25	3	0. 715	DYF10403190 PE00E3336	 38X25	1. 9	0. 59
DYF10244305 4150812	 50. 8X50. 8	3. 05	1. 475	DYF10279200 AA4524	 40X25	3	0. 661	DYF10305150 E3057	 16X16	1. 5	0. 226
DYF10245477 4150818	 50. 8X50. 8	4. 77	2. 25	DYF10280300 AA4600	 80X50	3	2. 016	DYF10409600 ME0002544	 100X50	6. 0	4. 332
DYF10157635 4151625	 101. 6X101. 6	6. 35	6. 251	DYF10160305 4161204126063	 76. 2X25. 4	3. 05	1. 589	DYF10296290 WE0000105	 38X38	2. 9	1. 099
DYF10158241 41504096063	 25. 4X25. 4	2. 41	0. 605	DYF10155305 4161206126063	 76. 2X38. 1	3. 05	1. 8	DYF10297200 WE0000864	 60X30	2	0. 92
DYF10159305 41516126063	 101. 6X101. 6	3. 05	3. 28	DYF10156305 4160804126063	 50. 8X25. 4	3. 05	1. 167	DYF10290250 ME0002936	 50X50	2. 5	1. 283
DYF10162305 41506126063	 38. 1X38. 1	3. 05	1. 158	DYF10161305 4161608126063	 101. 6X50. 8	3. 05	2. 435	DYF10291300 BE0002359	 76. 2X76. 2	3	2. 306
DYF10166305 4150612	 38. 1X38. 1	3. 05	1. 09	DYF10165478 4162408186063	 152. 4X50. 8	4. 78	5. 049	DYF10303250 E3852	 65X65	2. 5	1. 685
DYF10164305 41503126063	 19. 05X19. 05	3. 05	0. 532	DYF10258120 ME0000181	 20X20	1. 2	0. 243	DYF10289300 ME0003006	 25X25	3	0. 713



















































MẶT CẮT 1 SỐ THANH NHÔM TIÊU BIỂU

HÀNG HỘP											
DIE #	Sectional cross	Wall Thickness (mm)	Drawing weight (kg/m)	DIE #	Sectional cross	Wall Thickness (mm)	Drawing weight (kg/m)	DIE #	Sectional cross	Wall Thickness (mm)	Drawing weight (kg/m)
Rectangular bar											
DYG10449315 A037	 101.6X50.8	3.15	2.492	DYF10038050 DY6108	 25X12	0.5	0.097	DYF10535102 E-3520	 38.1x25.4	1.02	0.323
DYF10445236 CDW-134	 177.8X66.68	2.36	3.07	DYF10039060 DY6138	 38X38	0.6	0.243	DYF10670191 EXP-C-ST22075	 50.8X50.8	1.91	1.017
DYF10454120 WE0000452	 38X16	1.2	0.321	DYF10034055 DY6102	 38x25	0.55	0.184	DYF10496300 PE00E3408	 200X50	3.0	3.952
DYF10441160 PE00E3009	 25X25	1.6	0.318	DYF10035055 DY6103	 50x25	0.55	0.22	DYF10497478	 101.6X101.6	4.78	5.012
DYF10416120 ME0002142	 50X19	1.2	0.432	DYF10036050 DY6105	 20x12	0.5	0.084	DYF10464635	 101.6X101.6	6.35	6.321
DYF10417120 ME0002177	 19X19	1.2	0.231	DYF10037055 DY6125	 25x25	0.55	0.145	DYF10465318	 25.4X25.4	3.18	0.736
DYF10418120 ME0005051	 50X25	1.2	0.47	DYF10435315 SY-3193	 152X152	3.15	5.08	DYF10466305	 31.75X31.75	3.05	0.887
DYF10419160 ME0005052	 38X25	1.6	0.517	DYF10433300 A108	 152X50	3.0	3.191	DYF10467318	 38.1X38.1	3.18	1.119
DYF10420120 ME0005065	 25.4X25.4	1.2	0.314	DYF10434315 A003	 76.2X76.2	3.15	2.482	DYF10469635	 50.8X50.8	6.35	2.988
DYF10421120 ME0005058	 32X32	1.2	0.399	DYF10470100 ME0759	 16X5	1.0	0.103	DYF10468478	 38.1X38.1	4.78	1.721
DYF10404140 V-3415	 19.05X19.05	1.4	0.269	DYF10452135	 17.5X17.5	1.35	0.19	DYF10534102 E-6814	 38.1x38.1	1.02	0.41
DYF10405300 V-762	 76.2X38.1	3.0	1.774	DYF10482185	 101.6X25.4	1.85	1.227	DYF10533119 19704	 35.71x38.1	1.19	0.479
DYF10436180 AA4134	 50X50	1.8	0.898	DYF10493320 CA0002348	 46X46	3.2	1.424	DYF10572127 010529	 38.1x38.1	1.27	0.507
DYF10301102 27143	 17.26X11.51	1.02	0.142	DYF10490318	 76.2X50.8	3.18	2.009	DYF10531635	 101.6x50.8	6.35	4.62
DYF10444300 AA4099	 40X40	3.0	1.168	DYF10491478	 76.2X76.2	4.78	3.542	DYF10578226 PT#19-MB-204	 50.7x50.7	2.21	1.162
DYF10442300 AA4590	 80X40	3.0	1.853	DYF10498160 SHR251.6R2.5r2	 25x25	1.6	0.401	DYF10579226 PT#20-MB-228	 50.7x25.3	2.21	0.858
DYF10443300 AA4121	 50X50	3.0	1.466	DYF10489635	 50.8X50.8	6.35	2.989	DYG10652254 010531	 40.1x40.1	2.54	1.035







































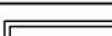





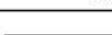





MẶT CẮT 1 SỐ THANH NHÔM TIÊU BIỂU

HÀNG HỘP											
DIE #	Sectional cross	Wall Thickness (mm)	Drawing weight (kg/m)	DIE #	Sectional cross	Wall Thickness (mm)	Drawing weight (kg/m)	DIE #	Sectional cross	Wall Thickness (mm)	Drawing weight (kg/m)
Rectangular bar											
DYF10584300 ME0565	 75x50	3.0	1.928	DYF10632475 ME0002079	 45.25x45.25	4.75	2.321	DYF10616160 BE0002611	 50x25	1.6	0.620
DYF10585300 ME0002966	 40x20	3.0	0.875	DYF10629125 FA0616	 32x25	1.25	0.643	DYF10982241	 31.75x31.75	2.41	0.767
DYF10557500 PM0000424	 50x50	5.0	2.430	DYF10627160 SE0001025	 50x38	1.6	0.733	DYF10969478	 50.8x25.4	4.78	1.672
DYF10661200 E3023	 38x25	2.0	0.637	DYF10628183 ME0003340	 19x9	1.83	0.340	DYF10970241	 31.75x31.75	2.41	0.728
DYF10565300 CA0000919	 40x25	3.0	0.956	DYF10638300 ME3007	 20x20	3.0	0.530	DYF10971318	 50.8x38.1	3.18	1.421
DYF10555600 CA0000381	 32x32	6.0	1.676	DYF10538200 ME0000574	 150x50		2.117	DYF10972318	 63.5x38.1	3.18	1.639
DYF10566200 ME1397	 90x90	2.0	1.882	DYF10622300 CA0001660	 20x20	3.0	0.551	DYF10974635	 63.5x63.5	6.35	3.846
DYF10541157 ME440	 19.05x19.05	1.57	0.291	DYF10656300 CA0001661	 40x20	3.0	0.875	DYF10609300 BE0003302	 100x40	3.0	2.171
DYF10532120 ME0005412	 100x19	1.2	0.756	DYF10655110 EE3000287	 50x10	1.1	0.2	DYF10607200 BE0003304	 38x25	2.0	0.622
DYF10683318 4805	 50.8x50.8	3.18	1.598	DYF10647500 WEA16	 50x50	5.0	2.430	DYF10604300 BE0003305	 32x32	3.0	0.928
DYF10719310 374B-H	 50.8x50.8	3.10	1.592	DYF10633250 CA0001090	 26x27	2.5	0.641	DYF10602120 BE0003307	 16x16	1.2	0.190
DYF10718107 AA0055B-H	 25.4x15.24	1.07	0.222	DYF10644160 E3013	 38x38	1.6	0.629	DYF10610200 BE0003308	 40x40	2.0	0.821
DYF10733122 395B	 19.05x19.05	1.22	0.233	DYF10618300 PM00269	 150x50	3.0	3.080	DYF10611200 BE0003309	 50x50	2.0	1.037
DYF10736318	 76.2x38.1	3.18	1.858	DYF10619600 BE0002570	 152x76	6.0	6.924	DYF10617600 BE0002566	 100x50	6.0	4.332
DYF10779140 CIA-E1117	 12.7x12.7	1.40	0.170	DYF10642300 PM00363	 100x25	3.0	1.859	DYF10601200 E3050	 38x38	2.0	0.778
DYF10784140 373C	 25.15x25.15	1.40	0.354	DYF10603200 BE0003306	 32x32	2.0	0.620	DYF10600160 E3025	 19x19	1.6	0.298
DYF10751180 8808B	 63.5x63.5	1.80	1.206	DYF10608300 BE0003303	 75x50	3.0	1.865	DYF10950635	 38.1x38.1	6.35	2.185











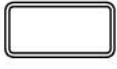









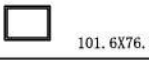





















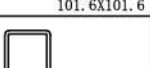





MẶT CẮT 1 SỐ THANH NHÔM TIÊU BIỂU

HÀNG HỘP											
DIE #	Sectional cross	Wall Thickness (mm)	Drawing weight (kg/m)	DIE #	Sectional cross	Wall Thickness (mm)	Drawing weight (kg/m)	DIE #	Sectional cross	Wall Thickness (mm)	Drawing weight (kg/m)
Rectangular bar											
DYF10681102 FS1058-050	 15.55x25	1.02	0.212	DYF10699305 T10034	 38.1x38.1	3.05	1.154	DYF10687112 4028	 35.92x38.1	1.09	0.437
DYF10615280 BE0002428	 16X16	2.8	0.399	DYF10549318 SHR50.83.18	 50.8x50.8	3.18	1.571	DYF10747250 WE0002084	 58X38	2.5	1.214
DYF10595200 BE0002893	 70x30	2.0	1.018	DYF10693500 CAD0000138	 40X40	5.00	1.888	DYT10777150 RH70201.5	 70X20	1.5	0.705
DYF10595200 BE0002893	 70x30	2.0	1.018	DYF10955157	 19.05x19.05	1.57	0.298	DYF10744150 ME0001943	 26X26	1.50	0.389
DYF10596305 T10037	 76.2x76.2	3.05	2.379	DYT10954635	 101.6x101.6	6.35	6.556	DYF10745180 ME0002227	 16X16	1.80	0.276
DYF10598318 FA0662	 76.2x38.1	3.18	1.937	DYF10661200 E3023	 38X25	2.0	0.637	DYF10680102 FU0625	 15.55x15.55	1.02	0.16
DYF10592350 CA0000204	 35x28	3.5	1.038	DYF10538200 ME0000574	 150X50	2.0	2.117	DYF10679080 MFU0625-035E	 15.55x15.55	0.8	0.127
DYF10593220 CA0000206	 35x20	2.2	0.603	DYF10622300 CA0001660	 20x20	3.0	0.551	DYF10678133 FW1010-062	 25x25	1.33	0.341
DYF10580160 E2118	 15.8x15.8	1.6	0.233	DYF10697200 SE0000975	 70X36.5	2.00	1.107	DYF10677102 FT7575-050	 18.7x18.7	1.02	0.195
DYF10556320 BE0002360	 100x100	3.2	3.345	DYF10700150 ME06123	 45X45	1.50	0.705	DYF10676278 PP1625-125	 40.815x40.815	2.78	1.146
DYF10583300 PE00E3064	 60x40	3.0	1.523	DYF10750140 373B	 25.4x25.4	1.40	0.358	DYF10675278 PE4040-125	 100.64x100.64	2.78	2.944
DYF10590150 E2177	 50x50	1.5	0.750	DYF10729140 CDW-90	 15.88x15.88	1.40	0.214	DYF10674278 PC2525-125	 62.79x62.79	2.78	1.808
DYF10591160 E3001	 38x25	1.6	0.517	DYF10755200 WE0000813 (X00184)	 30X30	2.0	0.586	DYF10673165 PB2525-075	 62.79x62.79	1.65	1.093
DYF10581160 E3001	 38x25	1.6	0.517	DYF10531635	 101.6x50.8	6.35	4.62	DYF10672278 PT2020-125	 50.09x50.09	2.78	1.423
DYF10582120 E3008	 19x19	1.2	0.231	DYF10695137 IFA-1998	 101.6x44.45	1.37	1.088	DYF10671127 P02020-060	 50.09x50.09	1.27	0.672
DYF10949318	 38.1x25.4	3.18	0.983	DYF10689097 4013	 38.1x25.4	0.94	0.298	DYF10735022 ME3001	 20X20	2.20	0.423
DYF10589350 E3733	 100x50	3.5	2.634	DYF10688097 4027	 38.1x38.1	0.94	0.376	DYF10740318 ME0002659	 38.1x17.45	3.18	0.845



















































MẶT CẮT 1 SỐ THANH NHÔM TIÊU BIỂU

HÀNG HỘP														
MÃ SỐ	MẶT CẮT	ĐỘ DÀY (mm)	TRỌNG LƯỢNG (kg/m)	MÃ SỐ	MẶT CẮT	ĐỘ DÀY (mm)	TRỌNG LƯỢNG (kg/m)	MÃ SỐ	MẶT CẮT	ĐỘ DÀY (mm)	TRỌNG LƯỢNG (kg/m)			
DYF10716250 SH382.5		38x38	2.50	0.958	DYF10789300 RH80253.0		80X25	3.0	1.604	DYF10787229 TMP-3714		25.4X25.4	2.29	0.558
DYF10717250 SHR382.5		38x38	2.50	0.938	DYF10829635		76.2X50.8	6.35	3.909	DYF10822318 50413		25.4X25.4	3.18	0.750
DYF10550100 SE0000337		71X13	1.00	0.443	DYF10863165 SNB703S2		25.4X25.4	1.65	0.418	DYF10780102 4006		25.4X25.4	0.99	0.245
DYF10698100 SE0000338		50x10	1.00	0.313	DYF10862224 SNB408S2		62.87X62.87	2.24	1.479	DYF10801300 SHR753.0		75X75	3.0	2.270
DYF10690150 WE0000262		60x20	1.50	0.624	DYF10861127 SNB694S1		18.42X18.42	1.27	0.237	DYF10885241		63.5X63.5	2.41	1.598
DYF10685650 ME0005355		102X51.5	6.5	4.792	DYF10860114 SNB653S1		15.49X15.49	1.14	0.179	DYF10892157		12.7X12.7	1.57	0.190
DYF10684150 SH12.71.5		12.7X12.7	1.50	0.181	DYF10864152 SNB407S1		5.08X50.8	1.52	0.819	DYF10891478		76.2X76.2	4.78	3.697
DYF10689160 RH50101.6		50X10	1.60	0.491	DYF10875318 1089		50.8X50.8	3.18	1.639	DYF10854250 CBU0160		44.5X38.1	2.5	1.059
DYF10790160 RHS75251.6		75X25	1.6	0.836	DYF10873140		15.9X15.9	1.4	0.220	DYF10898635		50.8X50.8	6.35	3.060
DYF10803300 ME06353		90X90	3.0	2.756	DYF10800635 GA4-610068		152.27X50.67	6.22	6.422	DYF10899318		76.2X25.4	3.18	1.639
DYF10703127 OP15.3956.TD8		15X15	1.27	0.189	DYF10796318 054314		25.3X79.27	3.12	2.312	DYF10900305		76.2X50.8	3.05	1.917
DYG10702157		50.8X50.8	1.57	0.838	DYF10797635 610236		101.47X25.3	6.27	3.882	DYF10897478		38.1X38.1	4.78	1.725
DYF10795300 OP15.3955.TD2		38X38	3.0	1.135	DYF10938119 PART#4032		76.2X38.1	1.17	0.695	DYF10926313		50.8X25.3	3.13	1.185
DYF10701203 OP11.2767.TD		50.8X50.8	2.03	1.073	DYF10799635 GA4-35079		101.47X50.67	6.22	4.709	DYF10925313		50.8X50.8	3.13	1.617
DYF10780102 4006		25.4X25.4	0.99	0.245	DYF10867318 DF450-32		114.3X44.45	3.18	2.412	DYF10924313		37.95X37.95	3.13	1.181
DYF10781140 4022		63.5X25.4	1.37	0.632	DYF10866216 DE451-32		114.3X50.8	2.16	2.487	DYF10923313		25.2X25.2	3.13	0.749
DYF10782152 4033		76.2X38.1	1.5	0.900	DYF10788152 5213		25.4X25.4	1.57	0.404	DYF10920152		18.92X18.92	1.52	0.287











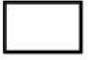

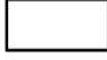

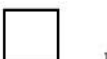

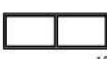















MẶT CẮT 1 SỐ THANH NHÔM TIÊU BIỂU

HÀNG HỘP											
MÃ SỐ	MẶT CẮT	ĐỘ DÀY (mm)	TRỌNG LƯỢNG (kg/m)	MÃ SỐ	MẶT CẮT	ĐỘ DÀY (mm)	TRỌNG LƯỢNG (kg/m)	MÃ SỐ	MẶT CẮT	ĐỘ DÀY (mm)	TRỌNG LƯỢNG (kg/m)
DYF10930300 RHR80403.0		3.0	1.791	DYF10975305		3.05	2.305	DYF11213000 ND0292			1.046
DYF10951165		1.65	0.311	DYF10977635		6.35	6.504	DYF10951165		1.65	0.311
DYF17046478		4.78	2.952	DYF10978318		3.18	0.765	DYF17046478		4.78	2.952
DYF10995231 ND0173		2.31	1.214	DYF10973318		3.18	2.028	DYF10983478		4.78	4.355
DYF10989000 ND0162			0.185	DYF10963318		3.18	2.076	DYF10950635		6.35	2.185
DYF11008310 ND0166		3.1	2.021	DYF10961318		3.18	0.546	DYF10949318		3.18	0.983
DYF11009185 ND0167		1.85	1.234	DYF10960478		4.78	3.651	DYF10955157		1.57	0.298
DYF11010310 ND0168		3.1	1.596	DYF10950635		6.35	2.185	DYF10985478		4.78	3.61
DYF11011152 ND0176		1.52	0.811	DYF10949318		3.18	0.983	DYF10985478		4.78	3.610
DYF10990318		3.18	1.204	DYF10955157		1.57	0.298	DYF11216120 WE00164		1.2	0.200
DYF10975305		3.05	2.305	DYT10954635		6.35	6.556	DYF11117318 RH76.250.83.18		3.18	2.079
DYF10977635		6.35	6.504	DYF10968478		4.78	5.012	DYF11121130 ME07057		1.3	0.401
DYF10978318		3.18	0.765	DYF17046478		4.78	2.952	DYF11112300 SHR1003.0R6R3		3.0	3.092
DYF10973318		3.18	2.028	DYF11209102 ND0283		1.02	0.234	DYF11114320 RHR38253.2R3R0.5		3.2	0.961
DYT10954635		6.35	6.556	DYF11206147 ND0276		1.47	0.382	DYF11113160 SHR251.6R1.6R0.5		1.6	0.400
DYF11210107 ND0277		1.07	0.281	DYF11207102 ND0284		1.02	0.304	DYF10962318		3.18	0.874
DYF11206147-rev1 ND0276-rev1		1.45	0.376	DYF11208305 ND0291		3.05	1.772	DYF10951165		1.65	0.311

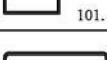

































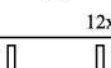















MẶT CẮT 1 SỐ THANH NHÔM TIÊU BIỂU

HÀNG HỘP														
MÃ SỐ	MẶT CẮT	ĐỘ DÀY (mm)	TRỌNG LƯỢNG (kg/m)	MÃ SỐ	MẶT CẮT	ĐỘ DÀY (mm)	TRỌNG LƯỢNG (kg/m)	MÃ SỐ	MẶT CẮT	ĐỘ DÀY (mm)	TRỌNG LƯỢNG (kg/m)			
DYF10936152 CDW-27		44.45X44.45	1.52	0.709	DYF11023065M MS 1230		30X20	0.65	0.172	DYF10826000 EPN-0646		18.64X18.64	0.183	
DYF10937152 CDW-28		101.6X44.45	1.52	1.181	DYF10013075M YE-76x25 0.75M		76X25	0.75	0.404	DYF10886224 EPN-0489		38.1X38.1	2.24	0.869
DYF10023039M SK-6105M		20X12	0.39	0.066	DYF10022060M THC-6125		25X25	0.6	0.158	DYF10844152 EPN-0595		50.8X50.8	1.52	0.811
DYF10002040M YE-25X12M		25X12	0.4	0.079	DYF10021060M THC-6103		50X25	0.6	0.240	DYF10842310 EPN-0597		50.8X50.8	3.10	1.596
DYF10022041M SK-6125M		25X25	0.41	0.110	DYF10020060M THC-6102		38X25	0.6	0.201	DYF10840185 EPN-0598		63.5X63.5	1.85	1.234
DYF10007056M YE-38X25M		38X25	0.56	0.186	DYF10023050M SK-6105M_Rev1		20X12	0.5	0.084	DYF10854250 CBU0160		44.5X38.1	2.5	1.059
DYF10021049M SK-6103M		50X25	0.49	0.197	DYF10022050M SK-6125M_Rev1		25X25	0.5	0.133	DYF10836310 EPN-0599		63.5X63.5	3.1	2.021
DYF10013061M YE-76X25M		76X25	0.61	0.328	DYF10002050M YE-25x12M_Rev1		25X12	0.5	0.098	DYF10827000 EPN-0663		15.37X15.37	0.151	
DYF10009065M YE-38X38M		38X38	0.65	0.263	DYF11039120 MH-TTK-R75161ZFT		75X16	1.2	0.614	DYF10876152 E15260		25.65X13.21	1.52	0.295
DYF10014059M YE-76.3X38.3M		76.3X38.3	0.59	0.363	DYF11038120 MH-TTK-R65161ZFT		65X16	1.2	0.554	DYF10868000		95.7X20.02	2.41	1.472
DYF10033088M DY7004M		76X44	0.88	0.563	DYF11030125 DN-1003		101.6X44.5	1.25	0.973	DYF10530180		63.5x25.4	1.8	0.834
DYF10018096M YE-100X44M		100X44	0.96	0.739	DYF11046318		152.4X25.4	3.18	2.950	DYF10793119 MS-69653		17.27x17.27	1.19	0.204
DYF10001036M YE-20X10M		20X10	0.36	0.057	DYF11051318		50.8X50.8	3.18	1.569	DYF10966160 DI-02610		12.7X12.7	1.6	0.193
DYF11018070M YH50x30		50X30	0.7	0.298	DYF11049165		25.4X25.4	1.65	0.425	DYF10967635 DI-02609		101.6X50.8	6.35	4.808
DYF10001050M YE-20x10M_Rev1		20X10	0.5	0.079	DYF11054150 MH 100x100		100X100	1.5	1.602	DYF11052114 09874		17.02X7.26	1.14	0.135
DYF11031115M YH-1221Y		76X76	1.15	0.932	DYF11026216		35.76X13.44	2.16	0.512	DYF11095157 EPN-471		83.06X44.96	1.57	1.044
DYF11022090M MS 1222S		100X25	0.9	0.601	DYF10667196 00372		50.8X50.8	1.96	1.035	DYF11094160 EPN-0649		111.51X61.98	1.6	1.442



















































MẶT CẮT 1 SỐ THANH NHÔM TIÊU BIỂU

HÀNG HỘP											
MÃ SỐ	MẶT CẮT	ĐỘ DÀY (mm)	TRỌNG LƯỢNG (kg/m)	MÃ SỐ	MẶT CẮT	ĐỘ DÀY (mm)	TRỌNG LƯỢNG (kg/m)	MÃ SỐ	MẶT CẮT	ĐỘ DÀY (mm)	TRỌNG LƯỢNG (kg/m)
DYF11063080M THC-1204	 38X25	0.8	0.266	DYF11130318	 101.6X50.8	3.18	2.513				
DYF11062083M THC-1219	 76X38	0.83	0.505	DYF11153318	 76.2X50.8	3.18	2.053				
DYF11054150M MH 100x100	 100X100	1.5	1.602	DYF11132100 PC16793	 35.6X29	1.0	0.337				
DYF11053318 GAV-SN01737	 152.4X50.8	3.18	3.770	DYF11145280 AE-13	 100X50	2.8	2.173				
DYF11074157	 25.4X25.4	1.57	0.407	DYF11162318	 38.1X25.4	3.18	0.913				
DYF11073478	 76.2X50.8	4.78	3.040	DYF11178305	 50.8X38.1	3.05	1.368				
DYF11089127 5631-H	 18.8X18.8	1.27	0.239	DYF11155089 9874	 16.76X7.01	0.89	0.106				
DYF11096318	 101.6X101.6	3.18	3.364	DYF11183318 AE2336	 31.75X31.75	3.18	0.971				
DYF11112300 SHR1003.0R6R3	 100X100	3.0	3.092	DYF11182157 AE1456	 31.75X31.75	1.57	0.503				
DYF11114320 RHR38253.2R3R0.5	 38X25	3.2	0.961	DYF11177318 ND0262	 50.8X50.8	3.18	1.620				
DYF11113160 SHR251.6R1.6R0.5	 25X25	1.6	0.400	DYG11159152	 15.88X15.88	1.52	0.237				
DYF11100635	 63.5X63.5	6.35	3.934	DYF11184305	 47.63X47.63	3.05	1.379				
DYF11101318	 101.6X101.6	3.18	3.387	DYF11188953	 76.2X76.2	9.53	6.884				
DYF11119318	 152.4X38.1	3.18	3.075	DYF11141114 7-3413	 12.7X12.7	1.14	0.143				
DYF11129000 EPN-0663-1	 15.37X15.37	.	0.157	DYF11143127 MH-65845	 19.05X12.7	1.27	0.201				
DYF11127000 EPN-0646-1	 18.64X18.64	.	0.203								
DYF11128250 RH50252.5R3r0.25	 50X25	2.5	0.928								



















































MẶT CẮT 1 SỐ THANH NHÔM TIÊU BIỂU

THANH U											
DIE #	Sectional cross	Wall Thickness (mm)	Drawing weight (kg/m)	DIE #	Sectional cross	Wall Thickness (mm)	Drawing weight (kg/m)	DIE #	Sectional cross	Wall Thickness (mm)	Drawing weight (kg/m)
DYT10011060 YE-004	 9.5x9.5	0.6±8%	0.044	DYT10295160	 50X25	1.6	0.42	DYT10341160 ME0000023	 10X15	1.6	0.159
DYT10012060 YE-003	 12x12	0.6±8%	0.056	DYT10294160	 50X20	1.6	0.376	DYT10354400 ME0000008	 80X40	4	1.641
DYT10033065 SY-6002	 12x12	0.65	0.061	DYT10285300 PE00E5013	 50X50	3	1.166	DYT10361300 PE00E5053	 50X50	3.0	1.166
DYT10034060 SK-6001	 9.5x9.5	0.6	0.044	DYT10275160 PE00E5004	 25X25	1.6	0.31	DYT10349300 PE00E5012	 80X25	3	1.004
DYT10035060 SK-6001B	 12x7	0.6	0.048	DYT10245476 394031005CC	 63.5X33.34	4.76		DYF10455300 A138	 50.8X50.8	3.0	1.18
DYT10065055 DY6001	 10x10	0.55	0.043	DYT10247318 394020804063	 50.8X25.4	3.18	0.81	DYT10391000 PE00E2491	 76.2X38.1		2.732
DYT10066055 DY6001B	 12x7	0.55	0.044	DYT10240635 394041206	 76.2X38.1	6.35	2.738	DYT10392793 PE00E2492	 101.6X50.8	7.93	4.061
DYT10067055 DY6002	 12x12	0.55	0.052	DYT10283160 PE00E5002	 16X16	1.6	0.193	DYT10350160 PE00E5001	 12X12	1.6	0.141
DYG10552600 AA2048	 80x40	6.0	2.425	DYT10276300 PE00E5009	 50X25	3	0.761	DYT10369160 ME0002934	 10X10	1.6	0.166
DYG10599150 SS6-81248	 23.8x20	1.5	0.254	DYT10288300 PE00E5050	 100X50	3	1.571	DYF10287150 CR0000006	 114X25.4	1.5	0.979
DYT10175112 TC147	 53.98X38.1	1.12	0.388	DYT10282300 PE00E5011	 40X25	3	0.801	DYT10367300 BE0000036	 60X32	3.0	0.959
DYT10176112 TC148	 53.98X25.4	1.12	0.311	DYT10279300 PE00E5010	 80X40	3	1.247	DYT10242476 394031608	 101.6X50.8	4.76	2.993
DYT10177112 TC216	 79.38X38.1	1.12	0.466	DYT10287300 PE00E5008	 40X25	3	0.68	DYT10239476 394031206	 76.2X38.1	4.76	2.198
DYT10178635	 101.6x50.8	6.35	3.794	DYT10284300 PE00E5007	 32X25	3	0.615	DYT10340150 SS6-83114	 23.5X10.5	1.5	0.161
DYT10290200	 38X19.05	2	0.394	DYT10281300 PE00E5006	 25X25	3	0.558	DYT10331000 AA2229	 152.4X63.5		5.208
DYT10203198 CST966	 19.05X14.29	1.98	0.26	DYT10278300 PE00E5005	 20X20	3	0.437	DYT10332000 AA2199	 127X63.5		5.269
DYT10292150 PM0000733	 25X20	1.5	0.251	DYT10286160 PE00E5003	 20X20	1.6	0.245	DYT10343000 394041608	 101.6X50.8		3.791





















MẶT CẮT 1 SỐ THANH NHÔM TIÊU BIỂU

THANH U											
DIE #	Sectional cross	Wall Thickness (mm)	Drawing weight (kg/m)	DIE #	Sectional cross	Wall Thickness (mm)	Drawing weight (kg/m)	DIE #	Sectional cross	Wall Thickness (mm)	Drawing weight (kg/m)
DYT10427114 ME0005059	 22. 22X25. 42	1. 14	0. 217	DYT10305152 IE 1621	 14. 17X19. 05	1. 52	0. 2	DYT10586140 WE0000823	 38x25	1. 4	0. 323
DYT10428114 ME0005061	 25. 27X25. 42	1. 14	0. 227	DYT10067055 DY6002	 12x12	0.55	0.052	DYT10597600 ME1645	 80x40	6. 0	2. 415
DYT10423120 ME00C5240	 38. 5X25	1. 2	0. 279	DYT10065055 DY6001	 10x10	0.55	0.043	DYT10540900 BE0002346	 100x50	9. 0	3. 800
DYT10424120 ME00C5241	 42X25	1. 2	0. 29	DYT10066055 DY6001B	 12x7	0.55	0.044	DYT10558160 SE0003036	 26x19	1. 6	0. 262
DYT10303159 IE1616	 15. 88X15. 88	1. 59	0. 192	DY100164080 DL-4726	 10X11. 95	0. 8	0. 07	DYT10545600 ME0001645	 80X40	6. 0	2. 415
DYT10304159 IE1618	 22. 23X22. 23	1. 59	0. 22	DYT10475180 A143U	 44X20	1. 8	0. 392	DYT10600200 BE0003301	 40x20	2. 0	0. 410
DYT10323158 IE1610-R	 9. 525X9. 525	1. 58	0. 11	DYT10479180 A140U	 38. 1X19	1. 8	0. 354	DYT10614160 ME0004327	 36.8x25.5	1. 6	0. 352
DYT10434150 WE0000703	 53X25	1. 5	0. 405					DYT10621300 ME0003367	 100x25	3. 0	1. 166
DYT10414300 PM0000364	 60X32	3. 0	0. 956	DYT10489714	 152. 4X50. 8	7. 14	5. 388	DYT10608300 PM00055	 40x20	3. 0	0. 599
DYT10417300 CA0001095	 100X25	3. 0	1. 166	DYT10490714	 203. 2X76. 2	7. 14	8. 339	DYT10606160 ME0003059	 20x16	1. 6	0. 210
DYT10416500 CA0001096	 100X45	5	2. 46	DYT10408475 S-12411	 127X44. 45	4. 75	2. 667	DYT10664100 SE0002486	 12.5x12.5	1. 0	0. 096
DYT10418000 ME0000135	 16. 5X28. 6		0. 216	DYT10376318 020239	 32. 13X63. 5	3. 18	1. 303	DYT10670635 ME0002941	 101. 6x50. 8	6. 35	3. 695
DYT10432150 WE0000704	 103X38	1. 5	0. 713	DYT10730792 C10000052	 101. 6x50. 8	7. 92	3. 747	DYT10705300 E5015	 25x12	3. 00	0. 348
DYT10377318 020238	 63. 5X19. 43	3. 18	1. 202	DYT10736173 QMI-123	 86. 11x45. 87	1. 73	0. 770	DYT10876267 543-HW-1	 53. 72X51. 82	2. 667	1. 075
DYG11395318	 63. 5X25. 78	3. 18	1. 248	DYT10512635	 76. 2X50. 8	6. 35	3. 245	DYT10742142 CDW-154	 80. 31x38. 1	1. 42	0. 590
DYT10411300 ME0003117	 40X40	3.	0. 923	DYT10678476	 127x50.8	4.76	3.722	DYT10763160 WE0002065	 53. 7X50	1. 6	0. 65
DYT10413000 PE00E2490	 127X63. 5		5. 25	DYT10634480 SE0003157	 100x45		2. 338	DYT10764160 WE0002066	 57. 7X30	1. 6	0. 494

MẶT CẮT 1 SỐ THANH NHÔM TIÊU BIỂU

THANH U											
MÃ SỐ	MẶT CẮT	ĐỘ DÀY (mm)	TRỌNG LƯỢNG (kg/m)	MÃ SỐ	MẶT CẮT	ĐỘ DÀY (mm)	TRỌNG LƯỢNG (kg/m)	MÃ SỐ	MẶT CẮT	ĐỘ DÀY (mm)	TRỌNG LƯỢNG (kg/m)
DYT10567160 ME0005332	 36. 8x14. 8	1. 6	0. 259	DYT10715117 IFA-1999	 12. 7x12. 7	1. 17	0. 113	DYT10035065M SK-6001BM	 12X7	0. 65	0. 053
DYT10568792 ME0003528	 152. 4x63. 5	7. 92	5. 188	DYT10734130 SE0001056	 54. 1X39. 8	1. 30	0. 460	DYT10034060M SK-6001M	 9. 5X9. 5	0. 6	0. 045
DYT10532150 ME0005246	 35. 5x55	1. 5	0. 577	DYT10740600 ME0002284	 80X40	6. 00	2. 397	DYT10012060M YE-003M	 12X12	0. 6	0. 057
DYT10555120 E2138	 53. 2x25	1. 2	0. 325	DYT10798300 ME000591	 20X32	3. 0	0. 632	DYG17955318 ND0216	 15. 88X25. 4	3. 18	0. 519
DYT10987200	 128. 59X128. 59	2. 0	1. 383	DYT10802200 CH50252. 0	 50X25	2. 0	0. 508	DYT11192241 o	 31. 75X25. 4	2. 41	0. 497
DYT10547300 PM0000575	 40. 5x25	3. 0	0. 667	DYT10800140 OP15. 3953. TD1	 25. 4X25. 4	1. 40	0. 278	DYT11175476 MS-61887	 127X38. 1	4. 76	2. 476
DYT10543150	 168. 3x25. 4	1. 5	1. 635	DYT10818198 D13259-R0	 25. 4X8. 34	1. 98	0. 191	DYT11209147 ND0280	 34. 93X34. 93	1. 47	0. 405
DYG12963140 ME0004797	 117X25. 9	1. 40	1. 109	DYT10817198 D13258-R0	 38. 1X12. 95	1. 98	0. 308	DYT11206147-rev1 ND0279-rev1	 38. 05X37. 82	1. 45	0. 433
DYT10688150 ME0004796	 92X24. 9	1. 50	0. 791	DYT10859262 543-HW	 65. 46X51. 82	2. 616	1. 144	DYT11209147-rev1 ND0280-rev1	 34. 93X34. 93	1. 45	0. 399
DYT10723150 SE00661	 30x20	1. 50	0. 288	DYT10836157 CIA-E1104M	 80. 92X38. 1	1. 57	0. 656	DYT11206147 ND0279	 38. 1x37. 82	1. 47	0. 441
DYT10753120 CAD0002507	 33. 4X50	1. 20	0. 418	DYT10882318	 19. 05X19. 05	3. 18	0. 437	DYT10621300 ME0003367	 100x25	3. 0	1. 166
DYT10752120 CAD0002506	 33. 4X25	1. 20	0. 256	DYT10891714	 127X50. 8	7. 14	4. 624	DYT10590300 ME0002935	 16x16	3. 0	0. 340
DYT10751130 CAD0001928	 42. 8X20	1. 30	0. 274	DYT10890476	 63. 5X38. 1	4. 76	1. 554	DYT10669111 ME0003118	 177. 8x76. 2	11. 1	7. 404
DYT10750130 CAD0001927	 42. 8X45	1. 30	0. 450	DYT10888635	 50. 8X38. 1	6. 35	1. 444	DYT10662250 ME0003755	 12x20	2. 5	0. 317
DYT10756300 ME0003635	 100X40	3. 00	1. 409	DYT10889318	 50. 8X25. 4	3. 18	0. 628	DYT10623160 ME0006002	 128. 2x75	1. 6	1. 188
DYT10720180 ME0004578	 44. 6X10	1. 80	0. 296	DYT11030000M YH-5009Y	 17. 6X6. 7	.	0. 146	DYT10540160 CA0000918	 25x65	1. 6	0. 561
DYT10719200 ME0003769	 36X10	2. 00	0. 280	DYT11155318	 25. 4X12. 7	3. 18	0. 382	DYT10533100 CA0000120	 38x26	1. 0	0. 256

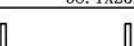
MẶT CẮT 1 SỐ THANH NHÔM TIÊU BIỂU

THANH U											
MÃ SỐ	MẶT CẮT	ĐỘ DÀY (mm)	TRỌNG LƯỢNG (kg/m)	MÃ SỐ	MẶT CẮT	ĐỘ DÀY (mm)	TRỌNG LƯỢNG (kg/m)	MÃ SỐ	MẶT CẮT	ĐỘ DÀY (mm)	TRỌNG LƯỢNG (kg/m)
DYT11146700 BE04525	 175X100	7.0	6.186								
DYT11147100 BE04526	 200X90	10.0	8.634								
DYT11210120 CH25251.2	 25X25	1.2	0.236								
DYT11211120 CH22.322.51.2	 22.3X22.5	1.2	0.211								
DYT10939000	 76.2X44.45		2.375								
DYT10993000	 152.4X63.5		5.22								
DYT10934318	 38.1X25.4	3.18	0.71								
DYT10934318	 38.1X25.4	3.18	0.71								
DYT10939000	 76.2X44.45		2.375								
DYT10968318	 50.8X50.8	3.18	1.256								
DYT10969635	 50.8X50.8	6.35	2.404								
DYT10955318	 12.7X19.05	3.18	0.382								
DYT10939000	 76.2X44.45		2.375								
DYT10941318	 63.5X38.1	3.18	1.147								
DYT10942318	 25.4X25.4	3.18	0.601	DYT10805300 CAD0001220	 30X12	3.0	0.316				
DYT10934318	 38.1X25.4	3.18	0.71	DYT10993000 0	 152.4X63.5		5.22				
DYT10943318	 76.2X25.4	3.18	1.038	DYT11145550 BE04524	 127X74	5.5	3.810				

CÔNG TY TNHH NHÔM ĐÔNG Á VIỆT NAM

ADD: Cụm công nghiệp Tân Dân-TP Chí Linh-tỉnh Hải Dương

TEL: (+84) 0220-3592956

WEB: www.nhomdonga.vn

FAX: (+84) 0220-3592987

E-mail: sales@nhomdonga.vn